

The Media Streaming Journal

September 2023

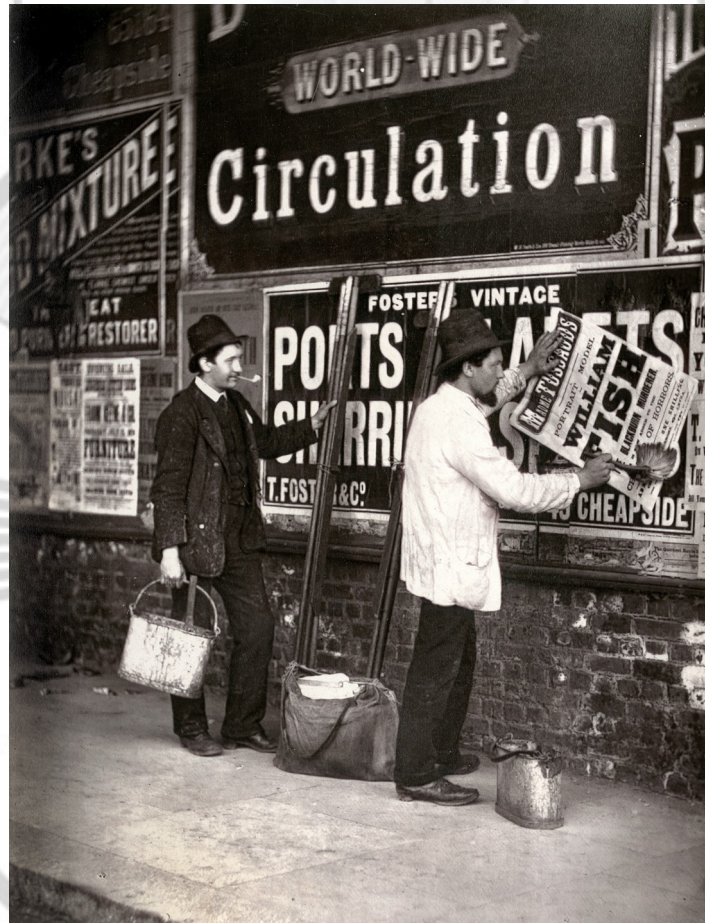

Covering Audio and Video
Internet Broadcasting

Brought To You By

RADIOSOLUTION

www.radiosolution.info



The Media Streaming Journal Staff

Derek Bullard
Publication Director
info@radiosolution.info

David Childers
Editor In Chief
editor@radiosolution.info

Advertising
advertising@radiosolution.info

www.radiosolution.info

publicdomainvectors.org/en/free-clipart/Vintage-microphone-vector-graphics/6111.html

Welcome to The Media Streaming Journal

Welcome to the latest edition of The Media Streaming Journal.

In the dynamic realm of digital media, understanding station marketing is crucial for creating and evolving digital broadcasters. The marketing concept encompasses the planning, establishing, and expanding web-based broadcast outlets and platforms, serving as the backbone for their growth and relevance in the modern media landscape.

Please feel free to contact either the Publication Director (Derek Bullard) or myself if you have any questions or comments regarding The Media Streaming Journal.

Namaste

David Childers

The Grand Master of Digital Disaster
(Editor In Chief)



www.linkedin.com/pub/david-childers/4/736/72a

The Media Streaming Journal

What is in this edition of the Media Streaming Journal

Foundations in Digital Marketing



Join our technical discussion on Facebook

<http://www.facebook.com/groups/internetradiosupport/>

Magazine cover:

[https://commons.wikimedia.org/wiki/File:Street_Advertising_\(5795814747\).jpg](https://commons.wikimedia.org/wiki/File:Street_Advertising_(5795814747).jpg)

**The Media Streaming Journal is licensed under the
Attribution-Share Alike 4.0 International
(CC BY-SA 4.0)
Creative Commons License.**

www.creativecommons.org/licenses/by-sa/4.0/



RADIO SOLUTION

www.radiosolution.info

Our Mission

Let our friendly, knowledgeable staff assist you to build your project, such as an online radio station using our high end reliable video and audio streaming technologies. We want to become your partner for all your hosting needs, as well as your one stop shop for radio products such as custom DJ drops and radio ID's.

Start An Internet Radio Station

Whatever you need to start Internet radio station, we will deliver! We provide high quality Internet Radio services to make your music radio project a success. We can provide Wowza, Iccast, SHOUTcast hosting and internet radio services to hobbyists, deejays, amateurs and established professionals. No radio station client is too big or too small for Radiosolution.

Choose between complete hassle-free service packages or new features to add to start internet radio station. Benefit from customized services and the latest in internet radio technology. You will receive professional, personalized and better Internet Radio Station services than you have received up till now. If you already have an Iccast or SHOUTcast hosting provider, we can still help you transfer your radio server over to us with no hassle and at no charge.

Internet Radio Station Services

Launch your internet, digital, satellite or AM/FM radio station anywhere in the world with all of the right tools. A broadcasting specialist is on standby to help you get started with an SHOUTcast or Iccast hosting package. We have servers ready for reliable streaming in North America and Europe. Our hosting packages have all the features you need to make your radio station project a success.

If you stream live or with an Auto DJ, we can provide you with the latest in web-based Cloud technology. You will love the simple to use control panel. Discover how easy it is to manage live deejays, upload fresh music and create custom scheduled programming. You will be able to track your listeners by getting real time statistics.

Starting your own Internet radio has never been easier. Get in touch with us anytime to start your Internet radio station.

Radiosolution is a SHOUTcast hosting provider located in Quebec Canada. We also offer Iccast, Wowza and Web Hosting services. Contact us to discuss the best option available as you start internet radio station. Radiosolution can provide personalized service in English, Dutch, and French. Starting an internet radio station can be intimidating, many people want to start one, but have no idea where to start. Radiosolution will be there for you every step of the way. Everyday people are searching the internet for free SHOUTcast servers. With Radiosolution SHOUTcast hosting we will allow you to try our services for FREE. By trying our services, you can be confident that you have chosen the best radio server hosting provider. You have nothing to loose because we offer a 30 day satisfaction guarantee. What are you waiting for? Contact us now! Radiosolution offers everything you need to start internet radio station. You will not need to go anywhere else. We can create your website, market your station and help you submit your station to online directories. We also feature the voice of Derek Bullard aka Dibblebee He can create affordable commercials, DJ intros, sweepers, jingles, ids and so much more.



icecast.org

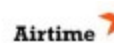

Hey You! Yes, You! Why Should Anyone Listen to You?!

Do you need compelling, clever copy or catchphrases for your Internet station? If you do, please visit and let's talk!

<http://www.ielectrify.com/work-with-me/>

I am a professional writer with 15+ years of experience creating high-converting copy, for a variety of radio, broadcasting and marketing applications.



https://www.wpclipart.com/people/professions/professions_3/radio_announcer.png.html

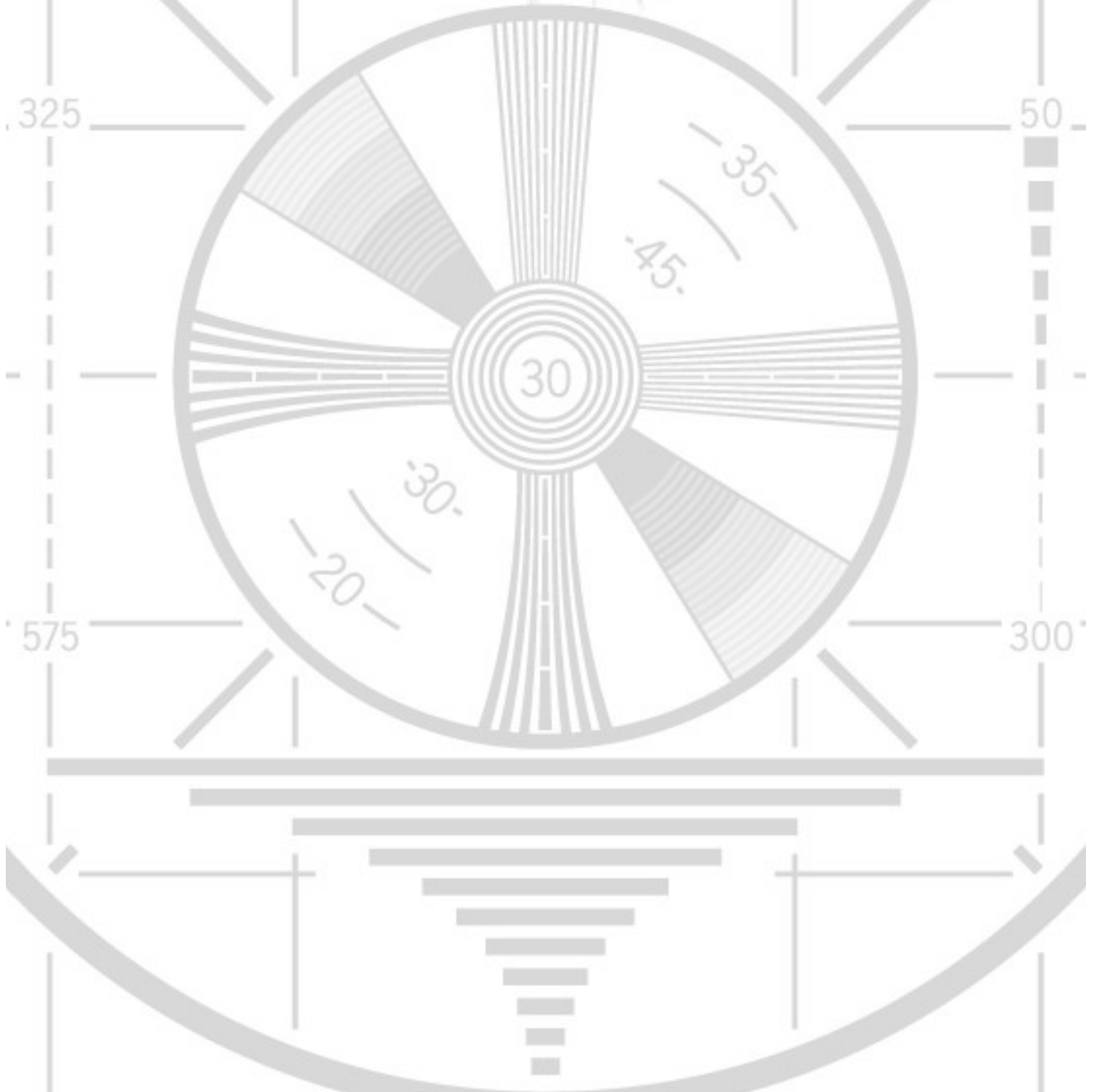

Foundations in Digital Marketing

Foundations in Digital Marketing is a textbook intended to introduce marketing students to the world of digital marketing. The book covers fundamental frameworks, practical applications, and online tools that can all be applied to build and execute a cohesive digital marketing strategy.

Rochelle Grayson
Licensed under a CC BY 4.0

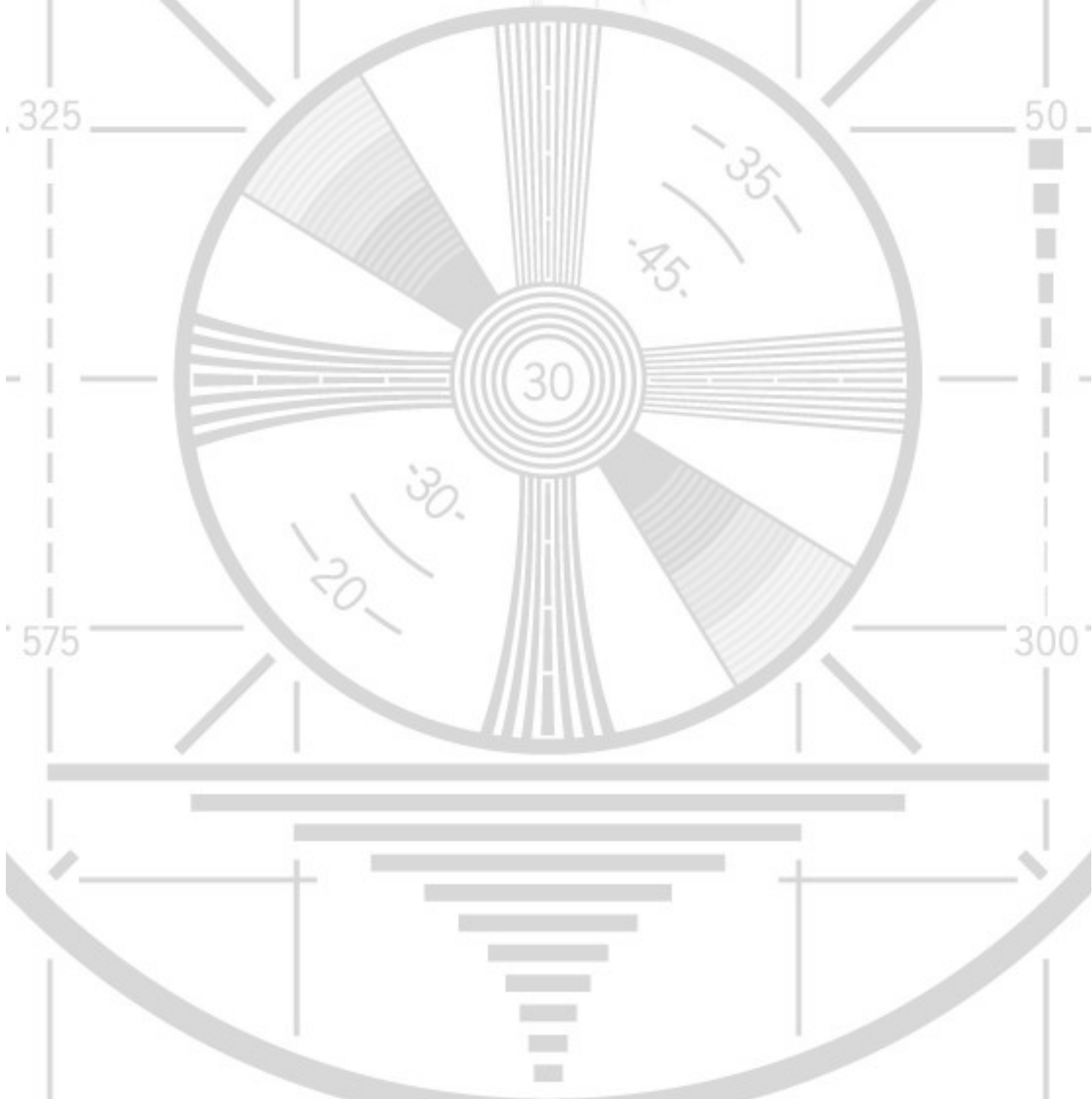
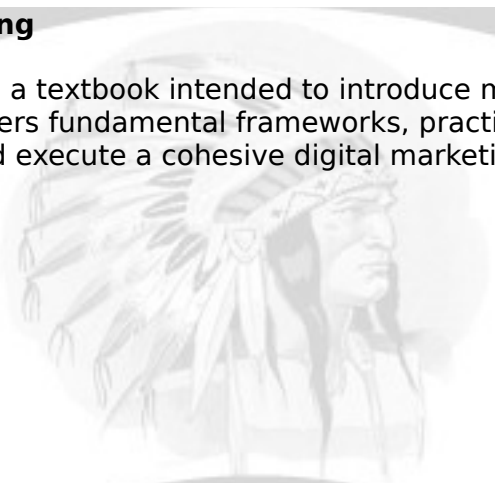

Foundations in Digital Marketing

Foundations in Digital Marketing

Building Meaningful Customer Relationships and Engaged Audiences

Rochelle Grayson

BCCAMPUS
VICTORIA, B.C.



Foundations in Digital Marketing by Rochelle Grayson is licensed under a Creative Commons Attribution 4.0 International License (<https://creativecommons.org/licenses/by/4.0/>), except where otherwise noted.

© 2023 Rochelle Grayson

The CC licence permits you to retain, reuse, copy, redistribute, and revise this book—in whole or in part—for free providing the author is attributed as follows:

Foundations in Digital Marketing by Rochelle Grayson is licensed under a CC BY 4.0 licence (<http://creativecommons.org/licenses/by/4.0/>).

If you redistribute all or part of this book, it is recommended the following statement be added to the copyright page so readers can access the original book at no cost:

Download for free from the B.C. Open Collection (<https://collection.bccampus.ca/>).

Sample APA-style citation (7th Edition):

Grayson, R. (2023). *Foundations in digital marketing*. BCcampus. <https://opentextbc.ca/foundationsdigitalmarketing/>

Cover image attribution:

“Email Marketing (<https://pixabay.com/vectors/email-email-marketing-newsletter-4284157/>)” by talhakhali007 (<https://pixabay.com/users/talhakhali007-5671515/>) is licensed under the Pixabay licence (<https://pixabay.com/service/license/>).

Ebook ISBN: 978-1-77420-217-3

Print ISBN: 978-1-77420-216-6

Visit BCcampus Open Education (<http://open.bccampus.ca/>) to learn about open education in British Columbia.

This book was produced with Pressbooks (<https://pressbooks.com>) and rendered with Prince.

Contents

Accessibility Statement	vii
For Students: How to Access and Use this Textbook	xi
About BCcampus Open Education	xiii
Introduction	1
Part I. Fundamentals of Digital Marketing	
1. Introduction to Digital Marketing	5
2. Fundamentals of Storytelling	15
3. Visual Storytelling	25
4. Visual Language & Sketchnoting	31
5. Target Market and Audiences	37
6. Customer Personas	51
7. Customer Journey Mapping	63
Part II. Generating Customer Demand and Nurturing Leads & Prospects	
8. A Lead Generation Framework	75
9. Content Marketing	87
10. Search Engine Optimization (SEO)	103
11. Website and Landing Page Optimization	111
12. Paid Advertising and Search Engine Marketing	125
13. Social Media Marketing	143
14. Mobile Marketing	165
15. Email Marketing	183
Part III. Analyzing and Optimizing Your Digital Marketing Performance	
16. A/B Testing	199
17. Attribution	207
18. Conversion Rate Optimization	217
19. Digital Marketing Analytics and Calculations	225

Part IV. The Future of Digital Marketing

20. Future Digital Marketing Trends	241
About the Author	247
Versioning History	249

Accessibility Statement

BCcampus Open Education believes that education must be available to everyone. This means supporting the creation of free, open, and accessible educational resources. We are actively committed to increasing the accessibility and usability of the resources we produce.

Accessibility of This Resource

The web version of this resource *Foundations in Digital Marketing* (<https://opentextbc.ca/foundationsdigitalmarketing/>) has been designed to meet Web Content Accessibility Guidelines 2.0 (<https://www.w3.org/TR/WCAG20/>), level AA. In addition, it follows all guidelines in Appendix A: Checklist for Accessibility (<https://opentextbc.ca/accessibilitytoolkit/back-matter/appendix-checklist-for-accessibility-toolkit/>) of the *Accessibility Toolkit – 2nd Edition* (<https://opentextbc.ca/accessibilitytoolkit/>). It includes:

- **Easy navigation.** This resource has a linked table of contents and uses headings in each chapter to make navigation easy.
- **Accessible videos.** All videos in this resource have captions (note that some videos only have automatically generated captions).
- **Accessible images.** All images in this resource that convey information have alternative text. Images that are decorative have empty alternative text.
- **Accessible links.** All links use descriptive link text.

Accessibility Checklist

Element	Requirements	Pass?
Headings	Content is organized under headings and subheadings that are used sequentially.	Yes
Images	Images that convey information include alternative text descriptions. These descriptions are provided in the alt text field, in the surrounding text, or linked to as a long description.	No
Images	Images and text do not rely on colour to convey information.	Yes
Images	Images that are purely decorative or are already described in the surrounding text contain empty alternative text descriptions. (Descriptive text is unnecessary if the image doesn't convey contextual content information.)	Yes
Tables	Tables include row and/or column headers that have the correct scope assigned.	Yes
Tables	Tables include a title or caption.	Yes
Tables	Tables do not have merged or split cells.	Yes
Tables	Tables have adequate cell padding.	Yes
Links	The link text describes the destination of the link.	Yes
Links	Links do not open new windows or tabs. If they do, a textual reference is included in the link text.	Yes
Links	Links to files include the file type in the link text.	Yes
Video	All videos include high-quality (i.e., not machine generated) captions of all speech content and relevant non-speech content.	No
Video	All videos with contextual visuals (graphs, charts, etc.) are described audibly in the video.	Yes
H5P	All H5P activities have been tested for accessibility by the H5P team and have passed their testing.	Yes
H5P	All H5P activities that include images, videos, and/or audio content meet the accessibility requirements for those media types.	Yes
Font	Font size is 12 point or higher for body text.	Yes
Font	Font size is 9 point for footnotes or endnotes.	Yes
Font	Font size can be zoomed to 200% in the webbook or eBook formats.	Yes

Known Accessibility Issues and Areas for Improvement

- Many flow chart images do not have high enough contrast between text and background colours.
- Two customer personas images in Customer Personas (#chapter-customer-personas) still need image descriptions.
- These videos do not have edited closed captions:

- How to Sketchnote without Drawing (<https://youtu.be/oNQJReku9Gw>) by Doug Neill (https://www.youtube.com/channel/UCuFm4ARxn306lX_OWMnz0-w)
- Bullet Journal / Planner Icon Doodles | Doodle with Me (<https://youtu.be/o1zdgGGUtNo>) by Doodles by Sarah (<https://www.youtube.com/c/sarazorel>)
- Customer Journey Map Workshop (<https://www.youtube.com/watch?v=X7iXcP-wlkk>) by PlaybookUX (<https://www.youtube.com/c/PlaybookUX>)
- KEY Web Design Principles: Navigation, Hierarchy & Color (<https://www.youtube.com/watch?v=GJN7TemsZtY>) by Flux Academy (<https://www.youtube.com/c/FluxWithRanSegall>)
- 11 Powerful SEO Link Building Strategies For 2021 (<https://www.youtube.com/watch?v=Rrh974qmbjk>) by IgniteVisibility (<https://www.youtube.com/user/IgniteVisibility>)
- What is personalization? (https://www.youtube.com/watch?v=U39SZCB_i9w) by Kameleon (<https://www.youtube.com/@kameleon17>)
- Attribution Modeling – An In-Depth Guide (<https://www.youtube.com/watch?v=Cr8UQXIcQ50>) by Humanlytics (<https://www.youtube.com/@humanlytics3533>)
- Experience Amsterdam: A Guided City Tour – 360 VR Video (<https://www.youtube.com/watch?v=FzrkpXlRP1M>) by VR Gorilla – Virtual Reality & 360 Videos (<https://www.youtube.com/@Vrgorilla1>)

Let Us Know if You are Having Problems Accessing This Book

We are always looking for ways to make our resources more accessible. If you have problems accessing this resource, please contact us to let us know so we can fix the issue.

Please include the following information:

- The name of the resource
- The location of the problem by providing a web address or page description.
- A description of the problem
- The computer, software, browser, and any assistive technology you are using that can help us diagnose and solve your issue (e.g., Windows 10, Google Chrome (Version 65.0.3325.181), NVDA screen reader)

You can contact us one of the following ways:

- Web form: BCCampus Open Ed Help (<https://collection.bccampus.ca/contact/>)
- Web form: Report an Error (<https://collection.bccampus.ca/report-error>)

This statement was last updated on March 23, 2023.

x Rochelle Grayson

The Accessibility Checklist table was adapted from one originally created by the Rebus Community (<https://press.rebus.community/the-rebus-guide-to-publishing-open-textbooks/back-matter/accessibility-assessment/>) and shared under a CC BY 4.0 licence.

For Students: How to Access and Use this Textbook

This textbook is available in the following formats:

- **Online webbook.** You can read this textbook online on a computer or mobile device in one of the following browsers: Chrome, Firefox, Edge, and Safari.
- **PDF.** You can download this book as a PDF to read on a computer (Digital PDF) or print it out (Print PDF).
- **Mobile.** If you want to read this textbook on your phone or tablet, you can use the EPUB (eReader) file.
- **HTML.** An HTML file can be opened in a browser. It has very little style so it doesn't look very nice, but some people might find it useful.

For more information about the accessibility of this textbook, see the Accessibility Statement.

You can access the online webbook and download any of the formats for free here: *Foundations in Digital Marketing* (<https://opentextbc.ca/foundationsdigitalmarketing/>). To download the book in a different format, look for the “Download this book” drop-down menu and select the file type you want.

How can I use the different formats?

Format	Internet required?	Device	Required apps	Accessibility Features	Screen reader compatible
Online webbook	Yes	Computer, tablet, phone	An Internet browser (Chrome, Firefox, Edge, or Safari)	WCAG 2.0 AA compliant, option to enlarge text, and compatible with browser text-to-speech tools	Yes
PDF	No	Computer, print copy	Adobe Reader (for reading on a computer) or a printer	Ability to highlight and annotate the text. If reading on the computer, you can zoom in.	Unsure
EPUB	No	Computer, tablet, phone	An eReader app	Option to enlarge text, change font style, size, and colour.	Unsure
HTML	No	Computer, tablet, phone	An Internet browser (Chrome, Firefox, Edge, or Safari)	WCAG 2.0 AA compliant and compatible with browser text-to-speech tools.	Yes

Tips for Using This Textbook

- **Search the textbook.**

- If using the online webbook, you can use the search bar in the top right corner to search the entire book for a key word or phrase. To search a specific chapter, open that chapter and use your browser's search feature by hitting **[Cntr] + [f]** on your keyboard if using a Windows computer or **[Command] + [f]** if using a Mac computer.
- The **[Cntr] + [f]** and **[Command] + [f]** keys will also allow you to search a PDF, HTML, and EPUB files if you are reading them on a computer.
- If using an eBook app to read this textbook, the app should have a built-in search tool.
- **Navigate the textbook.**
 - This textbook has a table of contents to help you navigate through the book easier. If using the online webbook, you can find the full table of contents on the book's homepage or by selecting "Contents" from the top menu when you are in a chapter.
- **Annotate the textbook.**
 - If you like to highlight or write on your textbooks, you can do that by getting a print copy, using the Digital PDF in Adobe Reader, or using the highlighting tools in eReader apps.

Webbook vs. All Other Formats

The webbook includes numerous interactive H5P activities. If you are not using the webbook to access this textbook, this content will not be included. Instead, your copy of the text will provided a link to where you can access that content online.

Even if you decide to use a PDF or a print copy to access the textbook, you can access the webbook and download any other formats at any time.

About BCcampus Open Education

Foundations in Digital Marketing by Rochelle Grayson was funded by BCcampus Open Education.

BCcampus Open Education (<https://open.bccampus.ca/>) began in 2012 as the B.C. Open Textbook Project with the goal of making post-secondary education in British Columbia more accessible by reducing students' costs through the use of open textbooks and other OER. BCcampus (<https://bccampus.ca/about-us/>) supports the post-secondary institutions of British Columbia as they adapt and evolve their teaching and learning practices to enable powerful learning opportunities for the students of B.C. BCcampus Open Education is funded by the British Columbia Ministry of Advanced Education and Skills Training (<https://www2.gov.bc.ca/gov/content/governments/organizational-structure/ministries-organizations/ministries/advanced-education-skills-training>) and the Hewlett Foundation (<http://www.hewlett.org/>).

Open educational resources (OER) are teaching, learning, and research resources that, through permissions granted by the copyright holder, allow others to use, distribute, keep, or make changes to them. Our open textbooks are openly licensed using a Creative Commons licence and are offered in various eBook formats free of charge, or as printed books that are available at cost.

For more information about open education in British Columbia, please visit the BCcampus Open Education (<https://open.bccampus.ca/>) website. If you are an instructor who is using this book for a course, please fill out our Adoption of an Open Textbook (<https://open.bccampus.ca/use-open-textbooks/tell-us-youre-using-an-open-textbook/>) form.

Introduction

Foundations in Digital Marketing is a textbook intended to introduce marketing students to the world of digital marketing. The book covers fundamental frameworks, practical applications, and online tools that can all be applied to build and execute a cohesive digital marketing strategy. The book covers the fundamental aspects of digital marketing, including areas such as:

- visual storytelling,
- design principles and frameworks,
- search engine optimization and marketing,
- website and landing page optimization,
- content marketing,
- content creation tools and technologies,
- paid advertising,
- social media marketing,
- mobile marketing,
- email marketing,
- attribution,
- conversion rate optimization,
- data and marketing analytics, and
- the future of digital marketing.

The book also features chapter learning objectives, videos, summaries, interactive learning activities, and discussion points, as well as, recommended industry certifications and online resources to augment the textbook.

I

Fundamentals of Digital Marketing

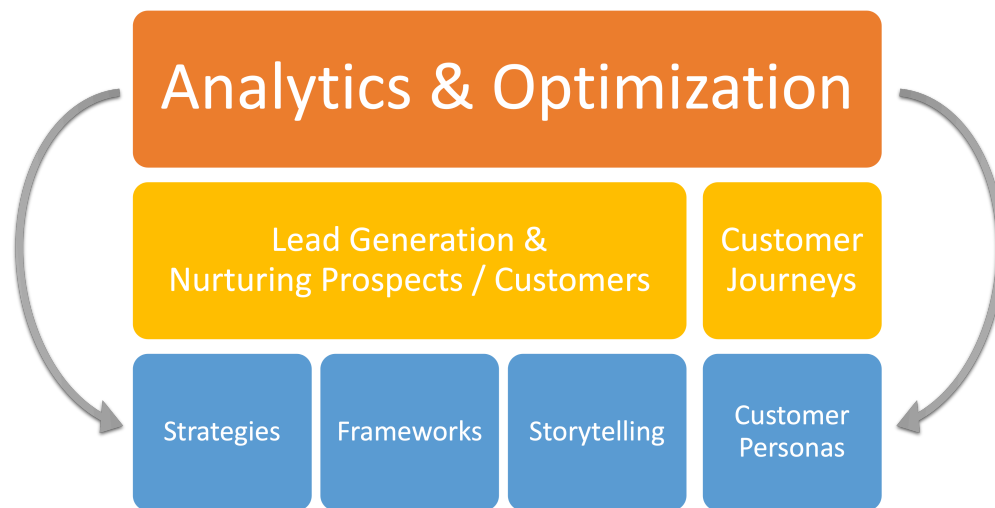

This textbook is divided into three core sections:

- I. Fundamentals in Digital Marketing (#part-fundamentals-of-digital-marketing)
- II. Generating Customer Demand and Nurturing Leads & Prospects (#part-generating-leads-and-customer-demand)
- III. Analyzing Your Digital Marketing Performance (#part-analyzing-and-optimizing-your-digital-marketing-performance)

In this first section, we will set the foundational building blocks and discuss fundamental theories, concepts, and frameworks essential to successful digital marketing strategies and campaigns. Specifically, we will:

- define digital marketing and its role,
- introduce an overarching digital marketing strategy framework,
- explore visual storytelling best practices,
- develop customer personas, and
- map out customer journeys.

Media Attributions

- Digital marketing textbook structure by Rochelle Grayson is licensed under a CC BY 4.0 licence.

1.

Introduction to Digital Marketing

Learning Objectives

By the end of this chapter, you should be able to:

- **Define** what digital marketing is and its global importance
- **Explain** the POEM Framework



What is Digital Marketing?

When people think of digital marketing, they often equate it to social media marketing. However, digital marketing is much broader than social media marketing; it covers a wide range of online marketing activities including:

- Content Marketing
- Search Engine Optimization (SEO)
- Website Management & Optimization
- Paid Advertising & Search Engine Marketing (SEM)
- Social Media Marketing
- Mobile Marketing

- Email Marketing

In this book, we will delve into each of these areas. However, before diving into those details, let's first define what digital marketing is. At its core, **digital marketing** builds meaningful relationships with target audiences using digital channels and tools. For many marketers, their target audience will likely be potential or existing customers. But, depending on your organization or the goals of your marketing activities, your target audience could also be:

- Employees (potential or existing)
- Senior leaders in your organization
- Investors / funding agencies
- Strategic partners / alliances

We will share more about this in the **Target Markets and Audiences** chapter, but please note that target audiences are not always defined as simply customers or clients.

Impact of the Global Pandemic

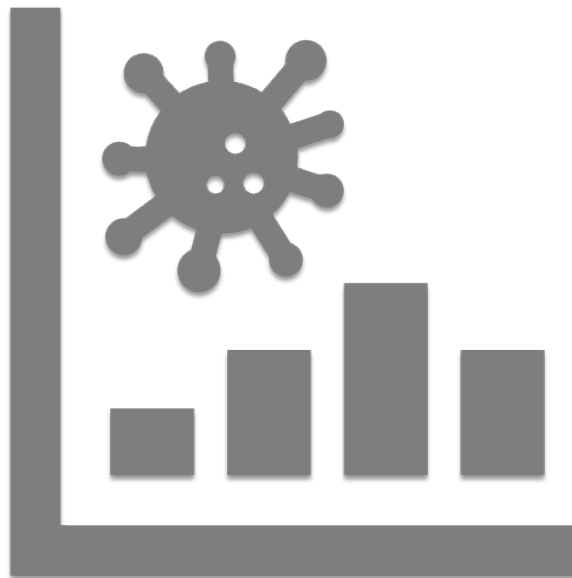

The global pandemic has had a significant impact on digital marketing. Since more people have been staying at home and/or working from home, there has been a huge increase in online activity. These large increases in online traffic have provided opportunities for organizations to further engage with their target audiences through digital marketing initiatives. As a result, digital marketing activity has increased exponentially in recent years. According to a recent study by market research firm, Global International Analyst, the global market for digital advertising and marketing was estimated at US\$350 Billion in 2020 and is projected to reach a US\$786.2 Billion by 2026.¹ And more than 75% of

1. Global Digital Advertising and Marketing Market to Reach \$786.2 Billion by 2026 (<https://www.prnewswire.com/news-releases/global-digital-advertising-and-marketing-market-to-reach-786-2-billion-by-2026--301331318.html>)

consumers took a new interest in online activities in 2020.² Of those, 21% purchased a product online for the first time. So, the global pandemic has clearly disrupted marketing as we knew it and accelerated the use of new digital marketing practices, which will continue to grow and evolve in the years to come.

Types of Media: POEM Framework

Despite these significant changes in the digital marketing landscape, there is still a proven marketing framework that many marketers continue to turn to for their marketing strategies: the POEM framework. The POEM framework can be applied to many marketing practices, e.g., social media marketing, search engine optimization and marketing, email marketing, print advertising, retail marketing, and many more.

POEM stands for **paid, owned, and earned media**. While not a new framework, POEM represents a foundational approach to any a digital marketing strategy. POEM can be used to formulate and guide your digital marketing strategy and tactics, allowing you to capture more qualified leads and deliver better results.

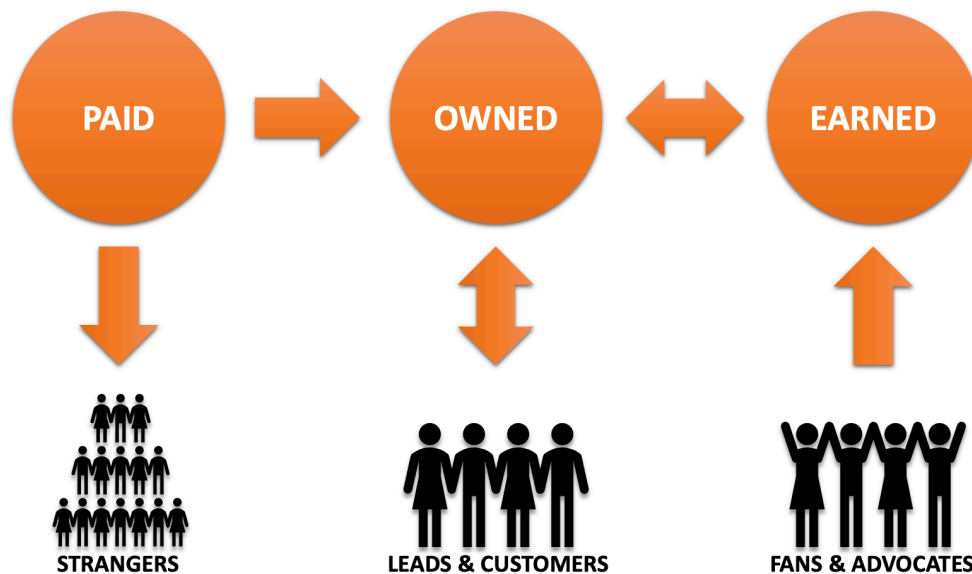

There are three key components to the POEM framework:

- **Paid Media** represents sponsored or paid ads that organizations run on various communication platforms. Digital examples include Facebook ads, Google ads, LinkedIn sponsored ads, banner or display ads, YouTube video ads, etc. However, offline paid media is also included, e.g., newspaper, radio, and magazine ads. In essence, paid media is any media where you pay to get exposure or access to an audience that you may not have an existing relationship with, i.e., “strangers”.
- **Owned Media** includes the content an organization creates and controls. Websites, e-

2. 2021 Global Consumer Trends Post-pandemic: How consumer behavior will continue to change [PDF] (<https://success.qualtrics.com/rs/542-FMF-412/images/Customer-Experience-Trends-2021-Report.pdf>)

newsletters, and blogs are good online examples. Offline examples could be a physical store, trade show booth, a paper newsletter, or even your employees (because they do represent your organization and your brand). The target audience for this type media is often prospective or existing customers.

- **Earned Media** represents content about your organization, services, or products, but created and distributed by others. Digital examples include shared posts, posts by customers about your organization, reviews, referrals, etc. Non-digital examples could include articles written by news organizations based on a press release or anyone who decides to write about your organization on their own. In essence, when you have earned the attention of your fans or advocates such that they “talk” about your brand, this is considered earned media.

While the above definitions may seem clear, not all media types fit nicely into a single category, for example:

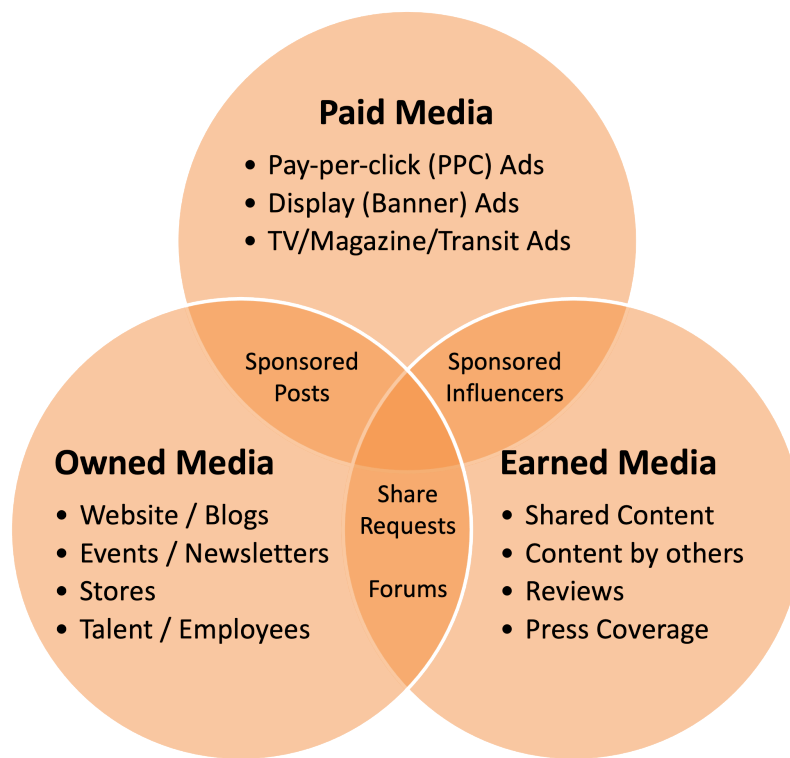

POEM Venn Diagram [Image description]

Sponsored or Boosted Social Media Posts: These posts are a combination of paid and owned media. This is because while paying to show the post to a specific audience, the post content itself is considered owned media because you have created it, and it lives on your social media account page.

- **Sponsored or Paid Influencers:** Posts from paid influencers are a combination of paid and earned media. Without payment, influencers’ comments or recommendations would be considered earned media. However, once influencers get paid to promote your brand, that earned media turns into paid media (with an earned media spin).
- **Social Media Share Requests:** Social media share requests could represent a combination of

earned media (the shared social media post) and owned media, if the organization requesting the share drafted or crafted the text for the post.

Because of these overlapping categories, POEM is sometimes referred to as POSE or PESO (paid, owned, *shared*, and earned media). Keeping this in mind, remember that some media types may straddle multiple categories.

H5P: POEM Categorization Exercise

Let's try categorizing various types of media...

Simply drag and drop the following words into the appropriate categories. *(You can drop the same word into multiple categories, if appropriate.)*

The diagram shows 14 media types in grey boxes arranged above three large orange circles labeled PAID, OWNED, and EARNED. The media types are: Unboxing Videos, Posts, Word-of-mouth Recommendations, Mobile Apps, Comments, Emails, Industry Articles, Sponsored Events, Coupons, Business Cards, Movie Trailers, Retweets, and Radio Ads.

When deployed together, paid, owned, and earned media can deliver impressive results, e.g., marketers can use:

- **Paid media to promote owned and earned media:** This approach helps your audience find any of your owned properties and/or earned conversations. For example, on a transit ad (paid media), you might display a customer review (earned media) and include a link to your own website (owned media).
- **Paid and owned media to generate and drive earned media:** The goal of this approach is to present content that can spark a public conversation. For example, you could boost a post (paid / owned media) from your social media page (owned media) to get your target audience talking or commenting about it (earned media).

- **Owned media to host earned media conversations:** This approach can be applied to collect ideas or feedback from your audience. For example, enable comments (earned media) on your blog (owned media). Or, host a contest or competition (earned media) on using your social media account (owned media).
- **Earned media to listen in on audience conversations:** This approach can provide insights about what your target audience likes, wants, or needs. For example, listen to social media conversations (earned media) that relate to your brand, your competitors, or your industry. Or offer real-time customer support to understand what is working or not.

Benefits and Challenges of the POEM Media Types

For each of the three media types – paid, owned, and earned – there are benefits and challenges. As a marketer, it is important to consider these strengths and weaknesses so that you can deliver the most effective results and outcomes:

Benefits and Challenges of the POEM Media Types

Media Type	Benefits	Challenges
Paid Media	<ul style="list-style-type: none"> • Immediacy: Marketers can get their media in front of target audiences much more quickly and efficiently. • Control: Because paid media is created by the brand and distributed through specific channels, the messaging is controlled and usually, cannot be changed or edited. • Wider Reach: Marketers can access larger audiences much more quickly and effectively. • Trackable: Most paid media systems can measure the behaviours of the audience and report on the media's performance. 	<ul style="list-style-type: none"> • Noise: Since people are bombarded with so many ads, it can be challenging to get your audience's attention. • Low Response Rates: Due to ad blockers and ad saturation, response rates continue to decline. • Less Credibility: While easy to promote, paid media can sometimes be perceived as spam or inappropriate.
Owned Media	<ul style="list-style-type: none"> • Brand Control: Since this media is developed and distributed by the brand, it represents the media that brands control the most. • Ability to Change: Brands can quickly create and adapt media to meet the ever-changing needs and interests of the audience. • Efficient Processes: Brands can ensure that these processes are efficient and match the structure(s) of their organizations and audiences. • Longevity of Content: Brands can make sure that this media is available / accessible for longer periods of time. 	<ul style="list-style-type: none"> • Relevance: If the brand does not know its audience well, the media may be perceived as irrelevant or uninteresting. • Mistrust: Many people do not trust communications that come directly from brands. • Difficulty in Scaling: It takes time and resources to organically build and grow a large audience.
Earned Media	<ul style="list-style-type: none"> • Most Credible: Posts written and shared by others carry the most credibility. They tend to be perceived as the most believable, authentic, genuine, and truthful. • Wider Reach: Getting others to share content with their own networks can exponentially increase a brand's reach and exposure. 	<ul style="list-style-type: none"> • Lack of Control: Brands cannot control what others say about them. • Negative Virality: Negative posts spread faster than positive ones and have the potential to go viral. • Hard to Track: When others post, it may be difficult to know who is hearing about your brand.

While some aspects of paid, owned, and earned media can be challenging, they are still essential

elements in creating a balanced, engaging digital marketing strategy and plan, regardless of channel. When you start developing your specific digital marketing strategies, consider each media category and leverage the unique benefits of each one.

Key Takeaways

- Digital marketing builds meaningful relationships with target audiences using digital channels and tools.
- Target audiences may not always be customers or clients. They could represent employees, funders, strategic partners, or any other stakeholders.
- The POEM framework is made up of three key components – paid, owned, and earned media.
- Regardless of marketing channel, POEM can help marketers build balanced and engaging digital marketing strategies / plans.

Digital Marketing – Exercises & Additional Resources

Exercises

- If digital marketing is about building relationships, what are some ways you build meaningful relationships in real life? How might those strategies also apply to digital marketing?
- Looking at an organization that you are part of, create a list of the media assets that might fit into each of these categories – paid, owned, and earned.

Additional Resources

At the end of each chapter, there will be additional resources listed that explore the chapter topics in more detail. These may include articles, videos, and/or industry certifications. For example:

- Google Fundamentals of Digital Marketing Course (<https://learndigital.withgoogle.com/digitalgarage/course/digital-marketing>).
(Free Industry Certification – 26 modules for ~40 hours)

Image Descriptions

POEM Venn Diagram:

A Venn Diagram with three overlapping circles showing examples of paid, owned, and earned media as well as examples that overlap.

- Paid media:
 - Pay-per-click (PPC) ads
 - Display (banner) ads
 - TV/magazine/transit ads
- Owned media:

- Website/blogs
- Events/newsletters
- Stores
- Talent/employees
- Earned media:
 - Shared content
 - Content by others
 - Reviews
 - Press coverage
- Overlap
 - Paid and owned media: Sponsored posts
 - Owned and earned media: Share requests, forums
 - Earned and paid media: Sponsored influencers

[Return to POEM Venn Diagram image]

Media Attributions

- Intro to digital marketing by Rochelle Grayson is licensed under a CC BY 4.0 licence.
- Global pandemic – graph with coronavirus and bar chart by Rochelle Grayson is licensed under a CC BY 4.0 licence.
- Paid, owned, and earned media framework and audiences by Rochelle Grayson is licensed under a CC BY 4.0 licence.
- POEM Venn diagram by Rochelle Grayson is licensed under a CC BY 4.0 licence.

2.

Fundamentals of Storytelling

Learning Objectives

By the end of this chapter, you should be able to:

- **Describe** the influence Indigenous storytelling has had on storytelling
- **Explain** the fundamental structure of telling stories
- **List** key storytelling techniques and questions to answer



Storytelling

A core skill for any digital marketer is the ability to tell compelling stories. As a result, storytelling is a critical element of any digital marketing strategy. So, let's explore storytelling. When learning something new, we often look to the masters for insights, inspiration, and guidance and when it comes to storytelling, **Indigenous Peoples across the world have been and continue to be master storytellers!**

Indigenous Peoples are distinct social and cultural groups that share collective ancestral ties to the lands and natural resources where they live, occupy, or from which they have been displaced. The land and natural resources on which they depend are inextricably linked to their identities, cultures, livelihoods, as well as their physical and spiritual well-being. Many Indigenous peoples still maintain a language distinct from the official language or languages of the country or region in which they reside. According to World Bank, there are currently approximately 476 million Indigenous Peoples worldwide, in over 90 countries. As a result, Indigenous Peoples and their stories span the entire globe and most of us are connected, at the very least ancestrally, to these precious societies and cultures.

Throughout history, Indigenous societies have relied on stories to share and pass down their histories, lessons, historical records, and other knowledge to maintain and sustain their cultures and identities. These Indigenous stories reflect the perceptions, relationships, beliefs and attitudes of the Indigenous Peoples and form the foundation of many Indigenous societies. While some may view these stories as peripheral, even in business today, we see the powerful influence of Indigenous storytelling in how marketers share stories with target audiences, convey historical information about their organizations, highlight “organizational identities and cultures”, and build communal experiences. Given this extensive history and expertise in Indigenous storytelling, we can learn a lot from these talented Indigenous storytellers who have been sharing and honing the art of storytelling for millennia.

From First Nations Indigenous storytellers, we learn that their Indigenous storytelling involves:¹

- Expert use of the voice
- Vocal and body expression
- Intonation
- The use of verbal imagery
- Facial animation
- Context
- Plot and character development
- Natural pacing of the telling, and
- Careful authentic recall of the story

So, how can we apply these indigenous storytelling techniques to our own organizational stories?

Tone and Brand Voice

What tone and voice resonates best with your target audience? Are you using the language and words that they use? While many marketers focus on the message and **what** they want to communicate, it is equally important to spend time thinking about the tone, language, dialog, and voice being used to communicate.

1. First Nations Pedagogy Online (<https://firstnationspedagogy.ca/storytelling.html>)

Tone Example

Consider the following lines from business emails. How would you describe the tone of each entry? What words, phrases, or other elements suggest that tone?

- “*Maybe if the project leader had set a reasonable schedule from the beginning, we wouldn’t be in this mess now.*”
- “*Whatever they’re paying you, it isn’t enough. Thanks for working so hard on this.*”
- “*I’m not sure what else is on your plate right now, but I need these numbers by this afternoon—actually in the next two hours.*”
- “*I cant remember when u said this was due.*”
- “*While I appreciate that your team is being pulled in a number of different directions right now, this project is my department’s main priority for the semester. What can we do from our end to set your group up to complete this by June?*”

Whether in a workplace or in our personal lives, most of us have received communications that we’ve found off-putting, inappropriate, or, at a minimum, curt. Striking the right tone and being diplomatic, particularly in business communication, can mean the difference between offending your reader and building important relationships. And more immediately, it can mean the difference between getting what you want and being ignored.

As with any piece of writing, considering audience, purpose, and type of information is key to constructing your communication. Truly finessing your writing so that it works *for* you, rather than against you, is key to forming strong relationships and being effective.

The above material is taken from Diplomacy, Tone, and Emphasis in Business Writing (<https://writingcommons.org/article/diplomacy-tone-and-emphasis-in-business-writing/>), in the Writing Commons (<https://writingcommons.org/>) and is used under a CC-BY-NC-ND 3.0 Unported license.

Consider these questions related to tone and voice:

- What is my intent? Am I trying to inform or to persuade?
- What tone and voice is most appropriate for the target audience?
- Are the tone and voice respectful?
- How can the content be presented so it is informative and persuasive but not condescending?
- What words demonstrate sensitivity to the audience’s views and feelings?
- Have any insensitive words or examples been presented that are likely to cause offence to the readers or viewers?

Imagery

Imagery is not just visual. Building on the previous point, there is **visual** imagery and **verbal** imagery. **Visual imagery** describes what we see and is what we traditional think about when we think of imagery, e.g., photographs, charts, icons, etc. **Verbal imagery** represents the **words and sounds** one uses to paint a clear picture in your audience’s minds. In many ways, verbal imagery can trigger stronger memories or emotions by connecting key words and sounds to important concepts, ideas, feelings, and yes, even brands. This is why jingles can be so effective in branding activities.

Verbal Imagery Example

Verbal imagery often requires providing additional details to support the specific situation being shared. While many may think verbal imagery describes the visual context using words, here is a simple example:

- **First Pass:** “Sam is a jerk.”
We all know jerks, but *why* is Sam a jerk?
- **Second Pass:** “Sam’s a jerk because they were mean to the barista preparing their coffee.”
We now have a clearer picture in our minds. Sam’s standing in a coffee shop and they are clearly not happy. But again, why is Sam unhappy?
- **Third Pass:** “Sam’s a jerk who is giving this unsuspecting barista a hard time because they are mad at their partner for making them drop their 5-year-old off at daycare before heading to work.”
We now have a much clearer impression of what Sam’s morning has been like and why Sam is unhappy.

Facial Animation

As more marketers explore videos and images, what facial expressions and animations are you including? The facial expressions shared can have a significant impact on your viewers. Are the people in your video smiling or frowning? Are they excited or indifferent? Are they puzzled or enlightened? And remember that even when writing a story, think about the words you are using (verbal imagery) to describe that facial expression and/or animation in your story.

Facial Animation Example

Happy and sad facial expressions may be easy to tell in many images. But what about more subtle expressions? Which emotion is being shown in the following photo?



Is this young woman sad, depressed, reflecting, thinking, or something else? Depending on how this photo is used, it could be interpreted in many different ways. Which brings us to our next point, the importance of context.

Context (or Setting)

All stories require context. Context orients us in place and time. Context tells the audience what the presented information means to them and why they should care. But be careful about just providing facts. Great marketers and storytellers provide rich context. Rich context goes beyond merely sharing **what** is the context and explores **why** this context is important or **how** this context might be applicable to even further-reaching circumstances. Rich context has multiple layers allowing it to resonate with a wider range of audiences. As we saw in the earlier verbal imagery example with “Sam”, adding more context allows the reader or viewer to better relate to what is being shared.

Plot and Character Development

Every story must have a beginning, middle, and end. The following image, also known as Freytag’s Pyramid, is a commonly used framework when developing stories. Please note that this approach can be used for any length of story – short or long.

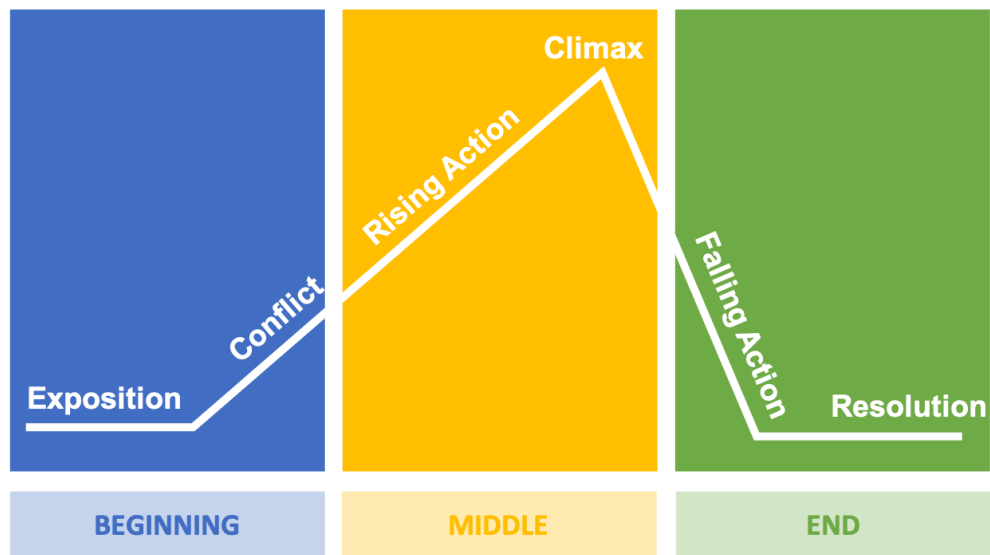

Freytag's Pyramid

Freytag' Pyramid

- **Exposition**
Exposition is the beginning of your story that introduces the 3 Cs: conflict (key issue / problem), characters (customers, perhaps?!), and the context.
- **Rising Actions**
Rising actions present the events before the climax, where your characters attempt to solve the problem (conflict) but fail.
- **Climax**
The climax represents the turning point or point of greatest suspense / action in your story.
- **Falling Actions**
Falling Actions are the actions and events that happen after the climax.
- **Resolution**
End of the story where the conflicts or problems are solved.

When you are telling your organizational stories, are you clearly including all of these elements? And are you walking your audiences through this entire storytelling journey?

Natural Pacing of the Telling

You need to spend time building your story by setting the foundational pieces in the beginning and middle of your story. Getting to your resolution too quickly can undermine the journey and steps required to get to that point. Take the appropriate time to build your story so that your climax truly presents a turning point in the audiences' journey.

Careful Authentic Recall of the Story

The best stories are those that are authentic, truthful, and clearly present the issues (conflict) and resolution. While many marketers may try to embellish their stories, stick to the facts and let the story tell the compelling narrative. If you feel the story needs to be embellished to make it more captivating, you may not have a story worth sharing.

Reflect:

Most of us heard Indigenous stories as children. (Remember that Indigenous Peoples and their stories span the entire globe; there are Indigenous Peoples of Africa, North America, South America, Asia, Australia, Europe, etc.) What made those Indigenous stories so impactful and how did those stories embody many of the best practices listed above?

As you can see, Indigenous storytelling's guidance and characteristics still apply today. It is why these stories have spanned millennia and continued to be shared. As marketers, we can learn how to best share compelling stories, as well as how to build and support engaged communities from these impressive Indigenous storytellers. And, as you begin to create your own organizational stories, think about the following questions:

CREATING YOUR STORY



- **What kind of story are you creating?**
 - employee story
 - customer story
 - organizational story

- market or industry story
- **Who is your audience?**
(This should align with the kind of story you are creating.)
 - employees
 - customers (potential and/or existing)
 - industry
 - market
- **What do you want your audience to:**
 - know
 - feel
 - see
 - do
- **How will it resonate with your audience's:**
(This should align with what you want your target audience's responses to be.)
 - needs
 - interests
 - goals / fears
 - doubts / misconceptions

And, don't forget that the core of your story should be based on the foundational principles and structure highlighted in Freytag's pyramid.

Key Takeaways

Telling compelling stories is part art and part science. When told well, stories can have a tremendous impact and influence on your audience. Here are some of the key takeaways in creating engaging and memorable stories:

- Indigenous storytellers are the masters. From them, marketers can learn how to tell compelling, engaging, and memorable stories. Some of the key Indigenous storytelling elements to include and consider are:
 - Expert use of the voice
 - Vocal and body expression
 - Intonation
 - The use of verbal imagery
 - Facial animation
 - Context
 - Plot and character development
 - Natural pacing of the telling, and

- Careful authentic recall of the story
- Every story should have a beginning, middle, and end. And, each story should have challenges (conflict), goals (climax), and context.
- Great stories incorporate tone, voice, imagery, facial expressions, plot and character development, pacing, and authentic recall.
- When creating stories think about:
 - the kind of story you are creating,
 - who is in your audience,
 - what you want your audience to know, feel, see, and do, and
 - how your story will resonate with your audience’s needs, interests, goals, fears, doubts, and misconceptions.

Storytelling Exercises

Below are a few exercises to apply and explore how stories are told:

- Share one of your favourite stories, e.g., a book, article, fairytale, legend, video game, movie, etc.
- Discuss the differences in how stories are told depending on the media, e.g., newspaper, magazines, TV, online articles, podcasts, short videos (like Instagram), movies, video games, etc.
- Hold a story-writing contest. You can keep the competition open-ended or suggest a starting point. For example, maybe start off with a place, an object, a person or creature, and a year. Also, allow the stories to be told using a variety of media types.

Media Attributions

- Group of people near bombfire (<https://unsplash.com/photos/fDostElVhN8>) by Tegan Mierle (<https://unsplash.com/@tegan>) is licensed under an Unsplash License (<https://unsplash.com/license>).
- Young woman sitting alone on a couch (https://www.freepik.com/free-photo/close-up-face-unhappy-asian-pretty-young-woman-sitting-alone-couch_5392735.htm) by jcomp (<https://www.freepik.com/jcomp>) is licensed under a Free License (https://www.freepikcompany.com/legal?_gl=1*ik6hlt*fp_ga*NTMyNTAyODE1LjE2NTg0MzQ5OTE.*fp_ga_QWX66025LC*MTY1ODQzNDk5MC4xLjEuMTY1ODQzNTM3MS4xNw..*test_ga*NTMyNTAyODE1LjE2NTg0MzQ5OTE.*test_ga_18B6QPTJPC*MTY1ODQzNDk5MC4xLjEuMTY1ODQzNTM3MS4xNw..#nav-freepik-license).
- Freytag’s Pyramid by Rochelle Grayson is licensed under a CC BY 4.0 licence.
- Creating your story by Rochelle Grayson is licensed under a CC BY 4.0 licence.

3.

Visual Storytelling

Learning Objectives

By the end of this chapter, you should be able to:

- **Define** visual storytelling
- **Explain** why visual storytelling is important



The Importance of Visuals and Why

Now that we've discussed how to tell compelling stories, let's look at **visual** storytelling and how it has become a critical way stories are told and shared today.

According to Wikipedia (https://en.wikipedia.org/wiki/Visual_narrative),

*“**Visual storytelling** (also visual narrative) is a story told primarily through the use of visual media. The story may be told using still photography, illustration, or video, and can be enhanced with graphics, music, voice and other audio.”*

One of the reasons visual storytelling is so powerful is because our brains are wired “visually”. Here are several mind-boggling statistics that explain why visual storytelling is so critical to the digital world we now live in:

- 90% of information transmitted to the brain is visual¹
- 50% of your brain is active in visual processing²
- 70% of your sensory receptors are in your eyes³
- It takes only 13 milliseconds for the human brain to process an image.⁴
- Our brain processes visuals 60,000 times faster than text.⁵
- 80% of people remember what they see,⁶ compared to ten percent what they hear and 20 percent of what they read.

But, what if some of the above information were presented as follows?

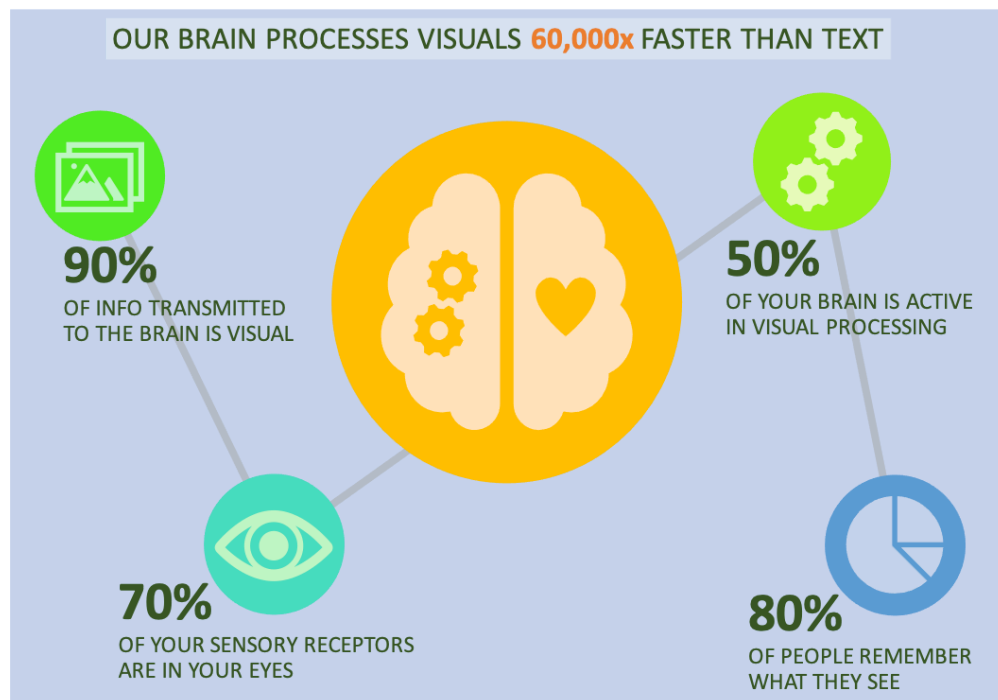

Do you prefer the bullets or the infographic?

1. Humans Process Visual Data Better (<https://www.t-sciences.com/news/humans-process-visual-data-better>)
2. How do we transform an ever-changing jumble of visual stimuli into the rich and coherent three-dimensional perception we know as sight? Rochester vision scientists are helping reshape our understanding of how the brain ‘sees.’ (https://www.rochester.edu/pr/Review/V74N4/0402_brainscience.html#:~:text=About%2070%25%20of%20all%20the,of%20what%20we're%20seeing.)
3. The Eye and Vision (<https://antranik.org/the-eye-and-vision/#:~:text=About%2070%25%20of%20all%20the,of%20what%20we're%20seeing.>)
4. What is the Impact of Visual Content Marketing? (<https://rocketium.com/academy/impact-visual-content-marketing/>)
5. Humans Process Visual Data Better (<https://www.t-sciences.com/news/humans-process-visual-data-better>)
6. 12 Hard Stats That Proof The Power Of Images (<https://www.searchenginepeople.com/blog/925-image-stats.html>)

In responses to a 2014 survey, 95% of B2B buyers said that they wanted shorter and highly visual content.⁷ And, organizations that feature visual content grow traffic 12 times faster than those who don't.⁸

Also, in comparison, we don't have much patience for text.

- Most people only read 20-28% of the words on the page.⁹
- 80% of people will watch a video¹⁰ but only 20% of people will read text on a page.
- 55% of website visitors spend less than 15 seconds actively reading.¹¹

Unfortunately, we are not great listeners, either. When people hear information, they're likely to remember only 10% of that information three days later. However, if a relevant image is paired with that same information, people retained 65% of the information¹² three days later.

We also love to consume and share pictures, infographics, and videos:

7. B2B Content Preferences Survey: Buyers Want Short, Visual, Mobile-Optimized Content (<https://www.demandgenreport.com/industry-topics/content-strategies/2746-b2b-content-preferences-survey-buyers-want-short-visual-mobile-optimized-content.html>)
8. The Rising Power of Visual Content [Infographic] (<https://www.socialmediatoday.com/news/the-rising-power-of-visual-content-infographic/508175/>)
9. The Power of Visual Communication (<https://www.lucidchart.com/blog/the-power-of-visual-communication>)
10. Digital Marketing by the Numbers: Stats, Demographics & Fun Facts (<https://www.omnicoreagency.com/digital-marketing-statistics/>)
11. Visual Content Statistics Infographic (<http://Visual Content Statistics Infographic Read more at: https://www.freelancinggig.com/blog/2017/12/09/visual-content-statistics-infographic/>)
12. Brain rule rundown (<http://brainrules.net/vision/>)

2021 This Is What Happens In An Internet Minute



2021: This is what happens in an Internet minute.

- More than 100 million photos and videos are posted daily on Instagram.¹³
- Tweets with images receive 150% more retweets¹⁴ than tweets without them.
- On Facebook, photos have an interaction rate of 87%,¹⁵ compared to 4% or less for other types of posts, such as links or text.
- 100 million hours of video are watched every day on Facebook-¹⁶ 85% of them with the sound off.
- 6 billion video ads¹⁷ are watched online each year.

13. Instagram by the Numbers: Stats, Demographics & Fun Facts (<https://www.omnicoreagency.com/instagram-statistics/>)

14. Link Tweet with an Image vs. Tweet with Twitter Cards, Does it Matter? (<https://www.agorapulse.com/social-media-lab/link-tweet-with-an-image-vs-tweet-with-twitter-cards-does-it-really-matter/#:~:text=Our%20friends%20at%20Buffer%20did,a%2035%25%20boost%20in%20Retweets.>)

15. Six Reasons to Embrace Visual Commerce in 2018 (<https://www.pixlee.com/blog/six-reasons-to-embrace-visual-commerce-in-2018/>)

16. 52 Video Marketing Statistics 2022 [Infographic] (<https://www.renderforest.com/blog/video-marketing-statistics>)

17. 52 Video Marketing Statistics 2022 [Infographic] (<https://www.renderforest.com/blog/video-marketing-statistics>)

- Posts that include images produce 650% higher engagement¹⁸ than text-only posts.
- People share infographics three times more¹⁹ than any other type of content.
- Using the word “video” in an email subject line²⁰ boosts open rates by 19% and clickthrough rates by 65%.

And, finally, from an organizational perspective, video drives our purchasing and/or conversion decisions:

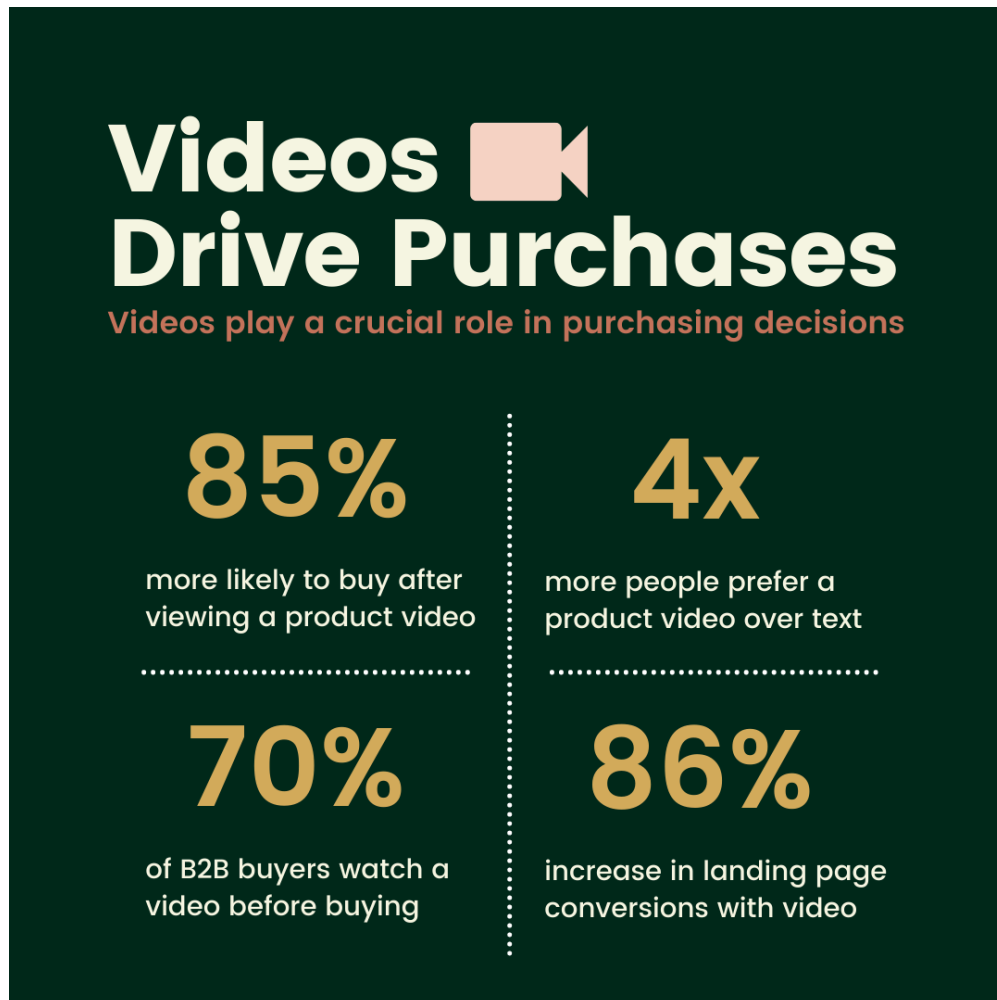

- 70% of B2B buyers and researchers watch a video during their purchase process.²¹
- Four times as many consumers would rather watch a video about a product than read about it.²²

18. 16 Visual Content Marketing Statistics That Will Wake You Up (<https://medium.com/marketing-and-entrepreneurship/16-visual-content-marketing-statistics-that-will-wake-you-up-59c4c0b80465>)

19. 15 Visual Content Marketing Statistics That'll Blow Your Mind (<https://www.jeffbullas.com/visual-content-marketing-statistics/>)

20. How to Increase Your Email Open and Click-through Rates (<https://www.walkaroundvideos.com/blog/2016/11/video-in-the-subject-line-increases-open-and-click-through-rates>)

21. A Step-by-Step Guide to Develop a Content Marketing Strategy That Converts (<https://www.crazyegg.com/blog/content-marketing-strategy/>)

22. The Rising Power of Visual Content [Infographic] (<https://www.socialmediatoday.com/news/the-rising-power-of-visual-content->

- People are 85 percent more likely to buy a product after viewing a product video.²³
- Videos on landing pages increase conversions by up to 86%.²⁴

Visuals are an important and inherent part of how we process information. And, as marketers with global audiences, relying on universal imagery, instead of specific written languages or words, allows your messages and stories to be much more accessible to a wider audience. So, if you are looking to have the greatest impact, internally or externally, you will need to understand how to present your story and information in a visual way that grabs your audience’s attention and tells a compelling story – which brings us to our next topic: visual language and sketchnoting.

Key Takeaways

Visual storytelling is a compelling way to share your stories and messages. Here are a few key takeaways:

- Our brains are naturally wired to process visual information quicker
- Most people tend to remember visual information better than text or audio information
- We love to consume and share pictures, infographics, and videos
- Videos play an critical role in our purchasing decisions

Exercise

Try your hand at visual storytelling:

- Using some of the statistics presented in this chapter, explore how you might represent them visually.

Media Attributions

- Visually thinking icon by Rochelle Grayson is licensed under a CC BY 4.0 licence.
- The reasons visuals are important by Rochelle Grayson is licensed under a CC BY 4.0 licence.
- What happens in an Internet minute – 2021 (<https://lorilewismedia.com/>) © Lori Lewis (<https://twitter.com/lorilewis>) and Chadd LunaLeKat (<https://twitter.com/officiallychadd?lang=en>) is for educational, non-commercial use only.
- Videos drives purchases by Rochelle Grayson is licensed under a CC BY 4.0 licence.

infographic/508175/)

23. 16 Eye-Popping Statistics You Need to Know About Visual Content Marketing Visual content marketing is one big trend you need to embrace. And for good reason (<https://www.inc.com/larry-kim/visual-content-marketing-16-eye-popping-statistics-you-need-to-know.html>).

24. 52 Video Marketing Statistics 2022 [Infographic] (<https://www.renderforest.com/blog/video-marketing-statistics>)

4.

Visual Language & Sketchnoting

Learning Objectives

By the end of this chapter, you should be able to:

- **Explain** what sketchnoting is
- **Translate** concepts, ideas, and objects into visual metaphors

Thinking & Speaking Visually

Now that we've discussed the key elements to developing a story and the importance of visual storytelling, let's explore what it means to visually express it. In order to think visually, you need to have the equivalent of visual "letters", words, and vocabulary to express your ideas visually. Often, we rely on written words to document or capture our thinking. But how might you express your thoughts and ideas visually?

While some people may think this requires exceptional drawing or artistry skills, that is incorrect. Anyone can express themselves visually and the best way to start practicing this is to start using a combination of text and "visual images" whenever you take notes or are jotting down ideas. Keep in mind that, much like handwritten notes, these "visual images" are not intended for broad consumption (or even viewing) by others. Rather they simply capture your ideas or perceptions using a visual icon, doodle, sketch, or basic drawing. This practice is commonly referred to as sketchnoting. **Sketchnoting**, also commonly referred to as visual notetaking, is the creative and graphic process, where people record their thoughts by using illustrations, symbols, structures, and texts (see example below).

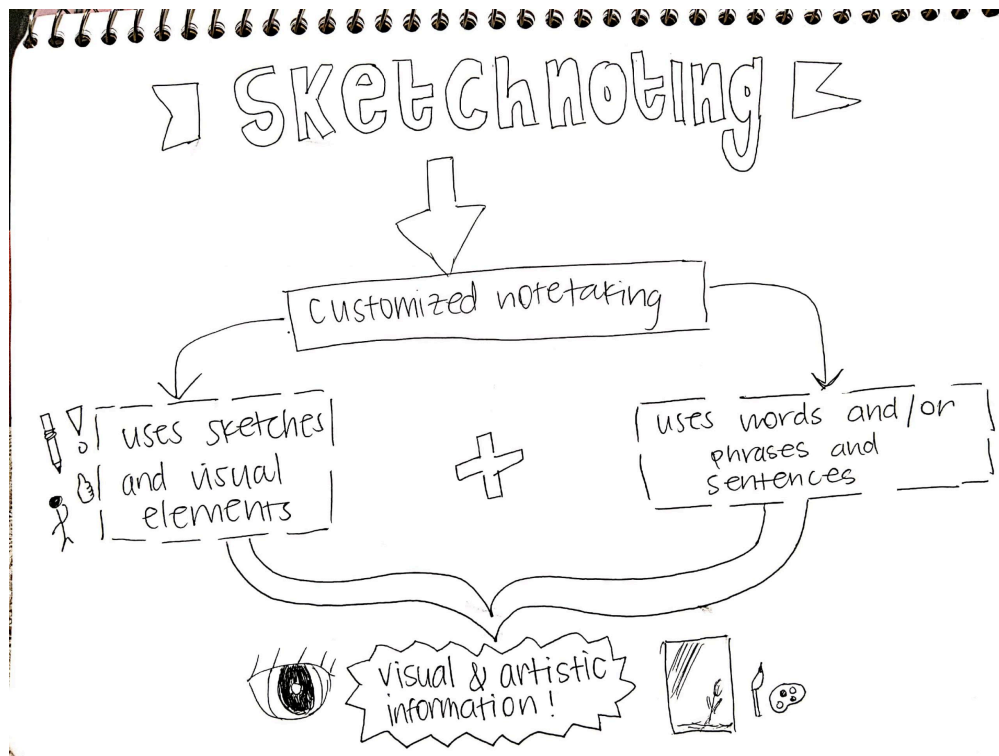

Sketchnoting Definition

Here is a great 12-minute video, How to Sketchnote without Drawing (<https://youtu.be/oNQJReku9Gw>):



One or more interactive elements has been excluded from this version of the text. You can view them online here: <https://opentextbc.ca/foundationsdigitalmarketing/?p=41#oembed-1> (#oembed-1)

In general, by engaging in visual notetaking, you can enhance your own learning, become a better problem solver, and better connect and share ideas.

In the following image, you will see that by combining handwritten text, basic shapes, containers, and many icons or symbols, it is possible to build a visualization that communicates your ideas and concepts much more clearly and with fewer words / text. And, remember that our brains are programmed to consume information visually. So, not only will this help you, but it will also be easier for others, regardless of their native language, to understand, as well!

TEXT:

Aa Bb Cc Dd Ee Ff Gg Hh Ii Jj
Kk Ll Mm Nn Oo Pp Qq Rr Ss Tt
Uu Vv Ww Xx Yy Zz

normal handwriting

BASIC SHAPES:

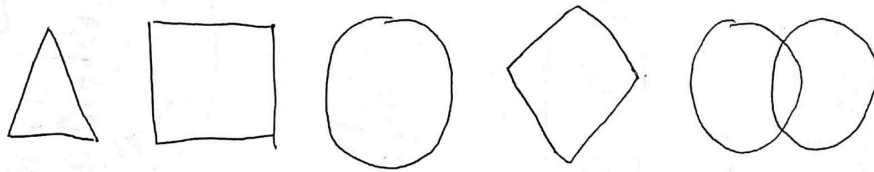

CONTAINERS:

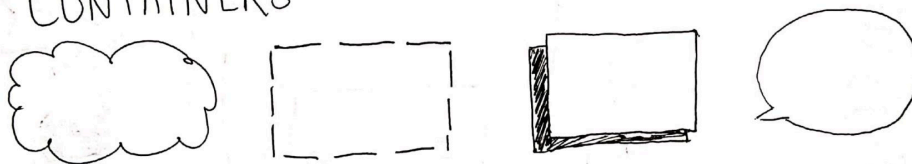

ICONS & SYMBOLS:

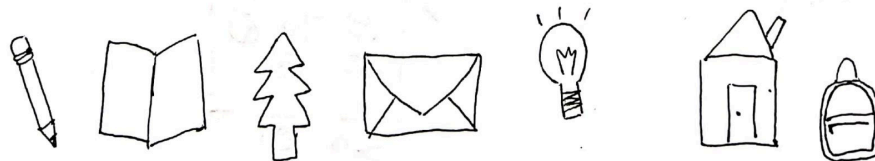

Sketchnoting elements

Surprisingly, most elements can be drawn using 5 basic drawing elements (see image below):

5 BASIC Elements
YOU CAN DRAW ANYTHING WITH JUST 5 BASIC ELEMENTS:

CIRCLE SQUARE TRIANGLE LINE DOT

Once you realize objects can be built from these 5 elements, it becomes easier to draw your ideas:

laptop house coffee flower car robot donut

NOT AN ARTIST? NOT A PROBLEM. THESE 5 BASIC ELEMENTS MAKE DRAWING EASIER.

Get more sketchnoting ideas for OneNote in *The Sketchnote Handbook* and *The Sketchnote Workbook* at rohdesign.com/books

MIKE ROHDE
SKETCHNOTES TIP #2

- Circle
- Square
- Triangle
- Line
- Dot

If you want some inspiration on how to hand-draw icons or symbols, you can either perform a Google image search on any term (concept, product, etc.) plus the word “icon”, e.g., “ad impression icon”, or you can watch the following 19-min video, **Bullet Journal / Planner Icon Doodles | Doodle with Me** (<https://youtu.be/o1zdgGGUtNo>):



One or more interactive elements has been excluded from this version of the text. You can view them online here: <https://opentextbc.ca/foundationsdigitalmarketing/?p=41#oembed-2> (#oembed-2)

In order to create better visual stories, you will need to practice using visual language yourself. Visual notetaking is a great way to practice for yourself and to begin thinking much more visually. Beyond **thinking** visually, it is essential to also understand how your visual stories can deliver value to your target audience, which brings us to our next topic – target markets and audiences.

Key Takeaways

Visual storytelling is an engaging way to share stories, ideas, and values.

- In order to tell stories visually, it is important to have a “visual language”.
- Sketchnoting is great way to train yourself to start thinking more visually and in visual metaphors.
- Sketchnoting may only be for your own consumption, but can be used to draft ideas and explore visual ways to present visual stories and ideas.

Exercises & Additional Resources

Like many new things, sketchnoting may feel challenging at first and may also take more time than simply writing down words. But, with practice, it does get easier and faster. Here are some exercises that can help you practice:

- Watch an educational, tutorial, or procedural video on a topic you find interesting. As you are watching it, document what you are learning by sketchnoting. Feel free to pause the video to think about how you can visually best represent your learnings and key takeaways. You can do the same with an educational, tutorial, or procedural podcast.
- List several key industry concepts or terms and come up with several possible symbols, icons, or sketches that could represent these terms.
- Take a written sentence or paragraph and “translate” it visually using sketchnotes.

Additional Visual & Audio Storytelling Tools & Resources

Many marketers argue that they are not creative or graphic designers. However, there are many online resources that provide beautiful templates as a starting point. As a result, marketers can focus on developing their story’s narrative and key messages and use the following **free** tools to visual their ideas:

(Some of these tools offer paid premium versions.)

- **Canva** (<http://canva.com>) (General Purpose Visual Media Designs & Editor)
- **Piktochart** (<https://piktochart.com/>) (Infographic / Visual Document Creator)
- **Visme** (<https://www.visme.co/>) (Visual Document Creator)
- **7 Elements Of A Great Product Video** (<https://idearocketanimation.com/14293-animated-product-videos/>) (with examples)
- **Free Stock Photos** –
 - **Freepik** (<https://www.freepik.com/>)
 - **Pexels** (<https://www.pexels.com/>)
 - **Pixabay** (<https://pixabay.com/>)
 - **Unsplash** (<https://unsplash.com/>)
 - **Canva Free Photos** (<https://www.canva.com/photos/free/>)
- **Videvo** (<https://www.videvo.net/>) (Stock Videos)
- **Vexteezy** (<https://www.vecteezy.com/>) (Vector Art, Stock Photos & Videos)
- **Powtoon** (<https://www.powtoon.com/>) (Animated Videos & Presentation Maker)
- **Biteable** (<https://biteable.com/>) (Animation & Video Maker)
- **Pixton** (<https://www.pixton.com/>) (Comic Strip Maker)
- **Animaker** (<https://www.animaker.com/>) (Animated Videos)
- **Moovly** (<https://www.moovly.com/>) (Video)
- **StoryboardThat** (<https://www.storyboardthat.com/business/team-and-business-edition>) (Storyboard / Comic Strip Maker)
- **iMovie** (<https://www.apple.com/ca/imovie/>) (Apple) (Video Production)
- **Microsoft Photos** (<https://www.microsoft.com/en-ca/p/microsoft-photos/9wzdncrfjbh4?activetab=pivot:overviewtab>) (Microsoft) (Video Production)
- **Adobe Spark** (<https://www.adobe.com/express/>) (Cloud-based Video Production)
- **Buzzsprout** (<https://www.buzzsprout.com/>) (Audio Podcasts)
- **Podbean** (<https://www.podbean.com/>) (Audio / Video Podcasts)
- **RedCircle** (<https://redcircle.com/>) (Audio Podcasts)

- **Anchor.fm** (<https://anchor.fm/>) (Audio Podcasts)
- **Bensound** (<https://www.bensound.com/>) (Free Audio Loops / Clips)
- **Looperman** (<https://www.looperman.com/loops>) (Free Audio Loops)
- **Envato** (<https://elements.envato.com/audio>)(Royalty Free Audio Clips)

Media Attributions

- How to Sketchnote without Drawing (<https://youtu.be/oNQJReku9Gw>) by Doug Neill (https://www.youtube.com/channel/UCuFm4ARxn306lX_OWMnz0-w) is licensed under a Standard YouTube License.
- Sketchnoting definition (<https://commons.wikimedia.org/w/index.php?curid=76687385>) by Amytangg is licensed under a CC BY-SA 4.0 licence.
- Sketchnoting elements (<https://commons.wikimedia.org/w/index.php?curid=76687386>) by Amytangg is licensed under a CC BY-SA 4.0 licence (<https://creativecommons.org/licenses/by-sa/4.0/deed.en>).
- OneNote sketchnote tip 2 – 5 basic elements (<https://www.flickr.com/photos/rohdesign/17029005032>) by Mike Rhode (<https://www.flickr.com/photos/rohdesign/>) is licensed under a CC BY-NC-ND 2.0 licence.
- Bullet Journal / Planner Icon Doodles | Doodle with Me (<https://youtu.be/o1zdgGGUtNo>) by Doodles by Sarah (<https://www.youtube.com/c/sarazorel>) is licensed under a Standard YouTube License.

5.

Target Market and Audiences

Learning Objectives

By the end of this chapter, you should be able to:

- **Define** segmentation, targeting, and positioning (STP)
- **Explain** the STP Framework

Introduction to the STP Framework

One of the quintessential questions repeatedly asked in marketing is:

- **What is your target market and more specifically, who is your target audience / customer?**

For many of you, these may seem like a very easy questions to answer. But, let's ask a few more detailed questions:

- Are there any differences between your *potential* customers and *existing* customers?
- Do all your existing customers behave the *same*?
- What patterns do you see within your existing customers, e.g., do you have “complainers”, “repeat users”, “loyalists”, “early adopters”, etc.?
- What patterns do you see with *potential* customers (also referred to as prospective customers or prospects)?

As you begin to look closely at your customers, you may start noticing that your customers vary quite a bit.

To better understand your customers, let's review a core marketing model that can help you define and scope out your target market and audiences, namely the STP framework. The STP process is a frequently used framework for today's digital marketers because of its customer-centric approach. The letters STP refer to customer **segmentation**, **targeting**, and **positioning**. In this chapter, we'll review each one of these areas in detail. Using this framework, you will be able to deliver personalized and

relevant digital marketing strategies that improve customers' experiences, as well as remain competitive.

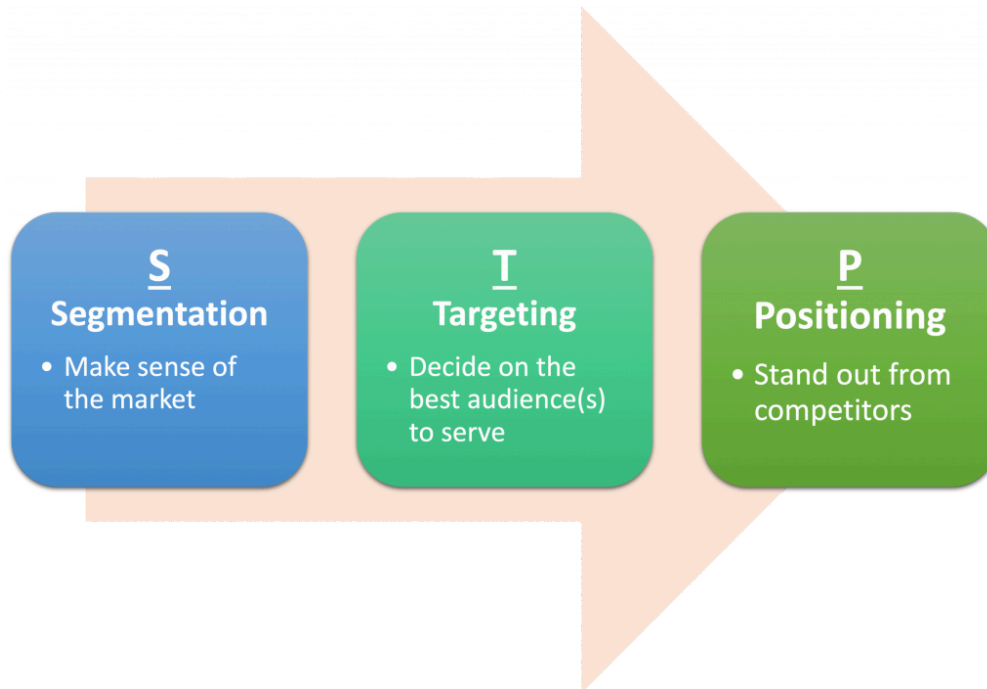

Definitions of Segmentation, Targeting, and Positioning

Segmentation can be defined as: Splitting up a market or audience into smaller-sized groups (segments) that have similar attributes, behaviours, or product / service needs.

Targeting (or target audience selection) refers to: Identifying an appropriate market or audience segment (or segments) to focus an organization's marketing efforts on.

Positioning (which is often described as product positioning) is: Communicating and differentiating a brand's key benefits and features, relative to the competition, to influence the target audience's perception of the brand.

The STP Process

The steps in STP are commonly described as a process, with segmentation being carried out first, followed by defining one or more target audience(s), then positioning your product or service appropriately, and finally, identifying the optimal marketing mix for each segment (see image below). A **marketing mix** is the set of marketing strategies or tactics that an organization uses to sell products or services to its target audience.



While the letters “STP” represent three important concepts in this framework, they are essentially one integrated process. They build on each other to deliver a high-level strategy, which determines your marketing mix. The objective of the STP process is to guide each organization to deliver the best experience for its targeted audience(s).

For more information on the STP framework and the marketing mix, please watch the following videos:

Watch: Segmentation, Targeting and Positioning – Learn Customer Analytics (9 mins)
(https://youtu.be/Fij1aBcl_Ts)



One or more interactive elements has been excluded from this version of the text. You can view them online here:
<https://opentextbc.ca/foundationdigitalmarketing/?p=52#oembed-1> (#oembed-1)

Watch: Marketing Mix – Learn Customer Analytics (10 mins) (<https://youtu.be/p6OIID3EB4Q>)



One or more interactive elements has been excluded from this version of the text. You can view them online here:
<https://opentextbc.ca/foundationdigitalmarketing/?p=52#oembed-2> (#oembed-2)

The diagram below shows how plans can flow from market segmentation to audience selection to product or service positioning. ()

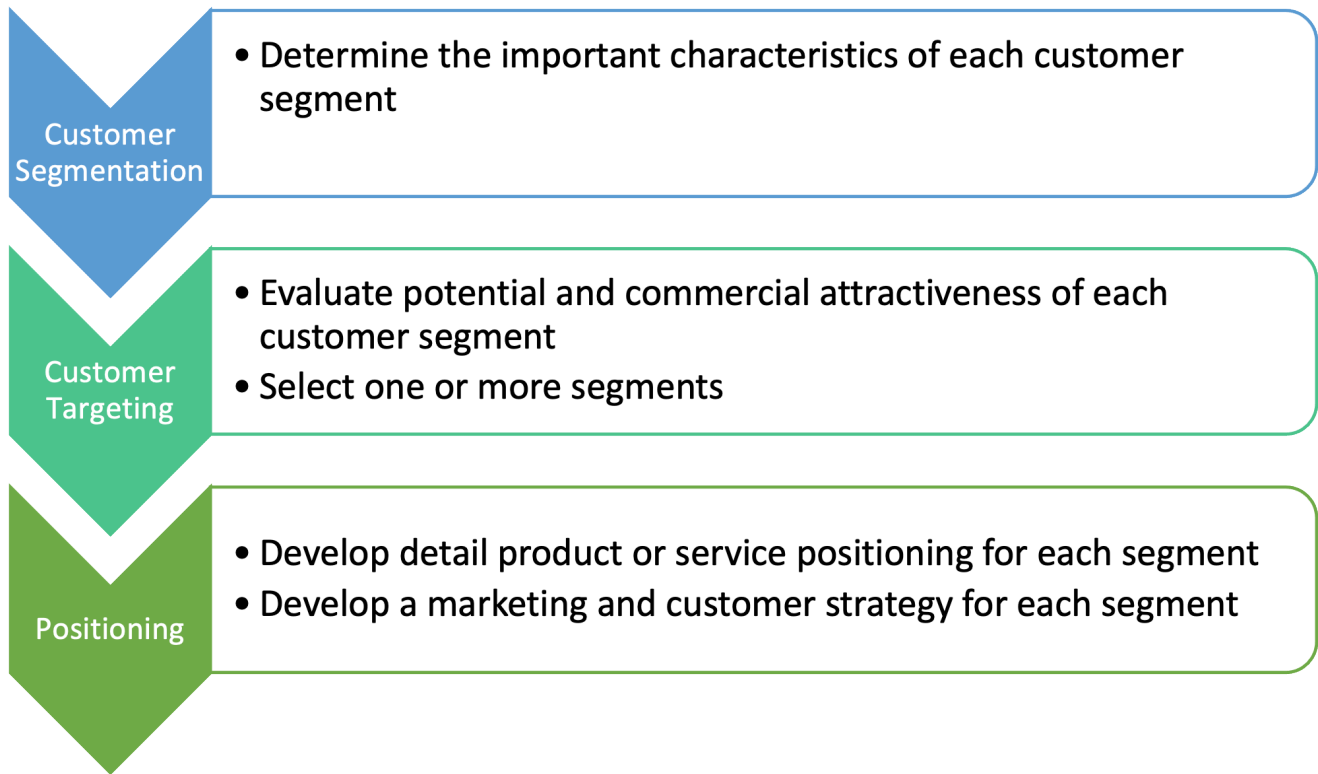

Flow of the STP Process Image Description (#stpprocessid)

In marketing, the STP components and processes answer several essential organizational questions, such as:

- **Where do we compete?**
This is addressed via your market and audience segmentation and your choice of the target audience(s).
- **How to we compete?**
This is answered by your positioning strategy as well as the execution of a supportive marketing and audience strategy, i.e., your marketing mix.

In essence, STP focuses on commercial effectiveness, selecting the most valuable segments for an organization and then developing a marketing strategy and product positioning strategy for each segment.

Segmentation



Many of you have probably heard about the Pareto principle (also called the 80/20 rule). The Pareto

principle states that for many outcomes roughly 80% of consequences come from 20% of the causes. For example, maybe 80% of your sales come from 20% of your customers. However, we are finding that marketers today find themselves in a post-Pareto world, where the causes and effects of consumer actions are driven by an even smaller, elite minority – meaning 80% of your revenues may come from only 5% of your customers. As a result, audience segmentation is critical in identifying those segments that are truly supporting your organizational goals and objectives.

With segmentation, you can identify specific customer niches that have particular needs, find new customers in mature markets, and provide even more focused and efficient marketing experiences. The requirements for each segment should be unique, allowing marketers to deliver personalized and relevant experiences instead of one-size-fits-all solutions. This technique has proven to be a lot more effective and can provide a tailored experience for your target audience.

Now, let's look at how you might segment your existing markets or audience:

1. **Demographics**

Historically, demographics have been the most popular way to segment audiences. This type of segmentation typically breaks down your market or audiences using any combination of the following:

- age,
- gender,
- income,
- education,
- ethnicity,
- marital status,
- education,
- household (or business) size,
- length of residence,
- type of residence, or
- even profession/occupation.

While this information is a great starting point, do be careful about lumping people together based solely on the above. As we are seeing, there is a wide range of diversity in our audiences; just because someone is a specific age or gender does not mean that they belong to a specific segment. For optimal segmentation, it is best to combine several of these segmentation options to create a fuller and more comprehensive profile of your target audiences.

2. **Geographic**

Using geographic data, marketers can drill down by country, region, area, neighbourhood, metropolitan or rural location, population density or even climate.

3. **Psychographics**

Psychographics represent some of the most important criteria marketers can reference in identifying ideal target audiences. Psychographics refers to 'personality and emotions', based on behaviours linked to purchase or engagement choices. Some common psychographics include:

- attitudes,
- lifestyle,
- hobbies,
- risk profiles, e.g., risk-averse or risk-seeking,
- personality and leadership traits,
- life stages,
- religious, political, nationalistic, or cultural beliefs and values

- publications or books read,
- entertainment (movies, TV, or music) preferences.
- websites visited,
- recreational pursuits and/or destinations, and

While demographics explain ‘who’ your audience is, psychographics inform you ‘why’ your audience buys or engages.

4. Behavioural

Behavioural attributes refer to the:

- nature of the purchase or engagement,
- brand loyalty,
- usage level,
- benefits sought,
- distribution channels used, and
- reaction to marketing factors.

For example, in a business-to-business (B2B) environment, the benefits sought might be: ‘how soon can it be delivered?’ In this case, segments might include a ‘last minute’ segment and a ‘planning in advance’ segment.

One helpful segmentation tool is the **PRIZM** (<https://prizm.environicsanalytics.com/>) segmentation tool. This online resource categorizes people into 66 different segments tied to postal codes. The PRIZM approach is based on the idea that “birds of a feather flock together,” suggesting that people tend to live near others similar to them. People who live in the same neighbourhood (geographic) often have similar demographic characteristics (income, age, family life cycle), have similar lifestyles and opinions (psychographics), and behave similarly (behavioural)

Go to **PRIZM** (<https://prizm.environicsanalytics.com/>) and type in your postal code. Does the description accurately describe your neighbourhood?

If your organization wants more detailed segmentation information, you can explore PRIZM’s more advanced, paid version called **DELTA**.¹ Please note that there are other segmentation tools, which cover different geographic areas and use slightly different approaches. For example, if you are in the US, you can use zip codes with **PRIZM**, **Claritas360** or **Tapestry**.^{2 3 4}

Tapestry profiles summarize the common lifestyle traits for the neighbourhood, and also include several key marketing factors about the group such as spending trends and shopping preferences. If you are looking at more international audiences, you can check out **Personicx** (<https://www.personicx.co.uk/>), developed by Acxiom, which identifies 55 clusters based on a combination of behavioural, lifestyle, and demographic factors.

By referencing similar data, marketers should be able to clearly identify the key behaviours and characteristics of not only existing audiences, but also those of future audiences.

1. For granular analysis of Canadian markets and consumers (<https://environicsanalytics.com/en-ca/data/segmentation/delta>)
2. See Canada Through a Whole New PRIZM® With Powerful Consumer Insights (<https://prizm.environicsanalytics.com/>)
3. Claritas360 (<https://claritas360.claritas.com/mybestsegments/#zipLookup>)
4. Tapestry (<https://www.esri.com/en-us/arcgis/products/data/overview?source=https%3A%2F%2Fwww.esri.com%2Fen-us%2Farcgis%2Fproducts%2Ftapestry-segmentation%2Fzip-lookup#data-demo>)

Criteria for Effective Segmentation

When evaluating the potential and commercial attractiveness of target segments, do keep in mind several of the following considerations:

- **Identifiable:** Each segment must be easily identifiable and unique.
- **Substantial:** The market must be large enough to justify segmenting. If the market is already small, segmenting it will only make it smaller.
- **Measurable:** Measurable differences must exist between segments.
- **Profitable:** Anticipated profits should exceed the costs of additional marketing plans, resources, and other activities.
- **Accessible:** Each segment should be accessible to your team and able to receive your marketing messages.
- **Unique:** Different segments should require different benefits.
- **Responsive:** Each segment should be willing to engage with and respond to your marketing mix.

Once you've decided on your target segments / audiences, it's time to look at targeting.

Targeting



After the segmentation process is complete, the next step is targeting, which involves choosing a segment or segments to target and engage with. There are four common targeting strategies that marketers can implement:

- Mass / undifferentiated
- Segmented / differentiated / multi-segmented
- Niche / concentrated
- Micromarketing

The table below describes each of these strategies and provides an example:

Targeting Strategies

Strategy	Description	Example
Mass / Undifferentiated	Sending the same marketing messages to everyone	Promoting your product or service by placing ads on widely read websites
Segmented / Differentiated / Multi-segment	Designing more than one marketing message / activity, with each communicating different benefits	Targeting multiple audience segments by communicating unique, personalized marketing messages about your product benefits in multiple marketing channels
Niche / Concentrated	Designing a marketing activity that communicates the benefits desired by a single specific segment	Promoting your product or service by targeting specific buyers via specific marketing channels, e.g., Whole Foods
Micromarketing	Design marketing messages / activities targeted at individual audience members or localized microsegments	Promoting your product or services to individual customers using individualized or localized offers, e.g., Groupon

Mass / Undifferentiated Targeting

An undifferentiated targeting strategy is used when an organization decides to communicate the benefits of its product or service by sending the same marketing message to everyone. For an undifferentiated strategy to be successful, the organization's product or service must be readily available and affordable and must provide the same benefits to all consumers. The success of mass or undifferentiated targeting depends on whether it is possible to reach enough customers, through mass-marketing techniques and one universal product offer, to keep customers interested in the product and make the strategy worthwhile. While mass-targeting tactics tend to be costly because they operate on a large scale, this approach can yield efficiencies and cost savings for organizations because it requires the marketing team to execute only one product offer and marketing mix. Many mass-targeted items are considered staple or "commodity" items. People buy new ones when the old ones wear out or are used up, and mass-targeted brand loyalty may be the primary driver when customers decide which replacement product to purchase.

Segmented / Differentiated Targeting

A differentiated targeting strategy is one in which the organization decides to provide separate offerings to different market segment that it targets. It is also sometimes called multi-segment targeting. Each segment is targeted in a particular way, as the organization provides unique benefits to different segments. The goal is to help the organization increase sales and market share across each segment it targets. When successful, differentiated targeting can create a very strong, entrenched market presence that is difficult for competitors to displace. However, differentiated targeting is also very expensive. It carries higher costs for the organization because it requires the development of unique products / services and marketing to fit each target segment. One example is Oreo cookie's differentiated targeting strategy for the Chinese market. Consumers there can enjoy Oreos with ice cream flavours such as green-tea ice cream, raspberry-blueberry, mango-orange, and grape-peach. All of these Oreo formulations have been heavily market tested and are based on the unique preferences of Chinese consumers.

Niche / Concentrated Targeting

Niche targeting (also called concentrated targeting) is a strategy that targets only one or a few well defined and specific segments of the target market. The goal is to achieve high penetration among the narrowly defined target segments. An organization that adopts a niche targeting strategy gains an advantage by focusing all its efforts on only one or a small handful of segments. When done well, this approach can provide a significant advantage over other organizations that don't have the same focus.

Niche targeting is particularly effective for smaller organizations with limited resources since it does not require mass production, mass distribution, or mass advertising. When an organization is highly successful in a desirable "niche" market, it can be very profitable. That said, the primary disadvantage of niche targeting is that organizations can become heavily reliant and dependent on these narrow markets. And if something changes and demand or interest drops, the organization has little cushion from the financial impact and therefore, is always somewhat at-risk. To protect themselves against this type of risk, organizations should target multiple niche segments, if possible.

Micromarketing

Micromarketing is a targeting strategy that focuses even more narrowly than niche targeting. It caters to the needs of individuals ("individual marketing") or very small segments in a targeted geography ("local marketing"). Micromarketing can be very powerful by giving customers exactly what they want, when they want it. However, to achieve large-scale success with this approach, organizations must figure out how to meet highly individualized needs efficiently and profitably.

Now, let's look at positioning.

Positioning



Once again, positioning relates to the target audience's perception of the product or service's key benefits and features, relative to the competition. To better understand how your target audience sees you relative to your competitors, marketers will often use a product positioning map (sometimes also called a perceptual map) to identify market opportunities, gaps, and even crowded markets to avoid. A **product positioning map** is a visual chart where organizations visually display the position of their products or services against their competition (see chart below).

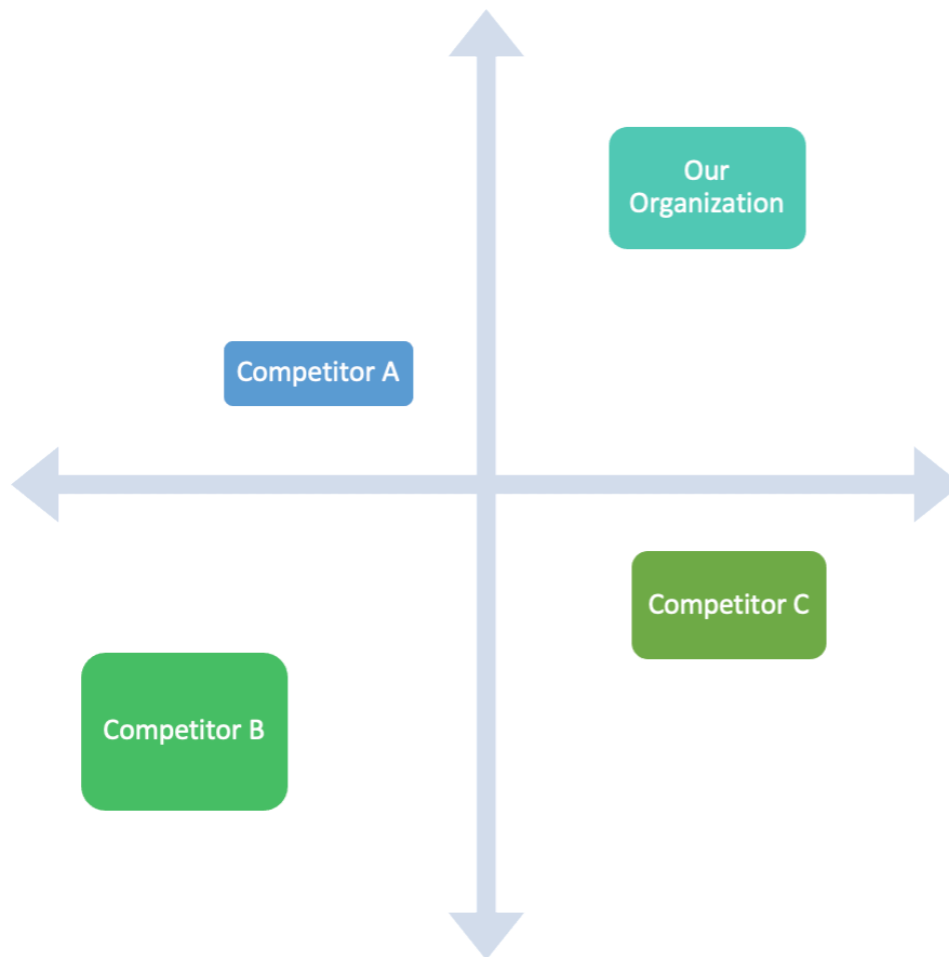

To create a positioning map, marketers need to decide which product or service characteristics to compare, i.e., the titles of the x- and y-axes. There are five common strategies upon which organizations often base their positioning:

- **Product / service characteristics and attributes**
Using product / service features or benefits associates your brand with certain characteristics that are beneficial to your target audience.
- **Price**
Usually, with a pricing positioning strategy, a brand aims to be the cheapest or one of the cheapest in the market, and value becomes their position.
- **Quality or luxury**
Positioning a product based on its high quality or ‘luxury’ is different from positioning based on price. While prices may signal a specific level of quality, many organizations promoting luxury items do not promote their prices. Rather, they focus on the quality of the customer experience. So, for clarity, we have separated the two.
- **Product use or application**
Associating your product with a particular use is another way to position your brand in the market. Many mobile apps use this type of positioning strategy, e.g., fitness apps target individuals who want to monitor and improve their fitness; whereas game apps focus on

people looking for entertainment.

- **Competition**

Competitor-based positioning focuses on using the competition as a reference point for differentiation.

The following perceptual map compares brands based on taste and nutritional value:

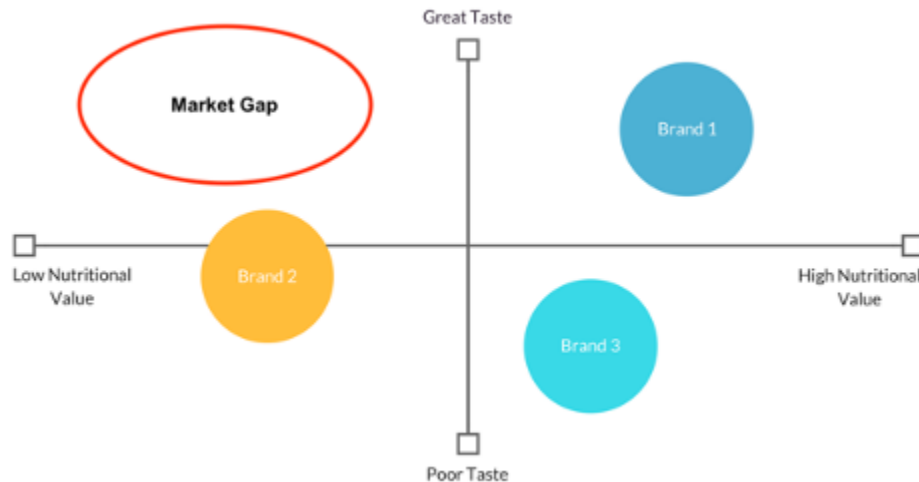

While we can see a market gap in the “Great taste / low nutritional value” area, marketers will still need to ask whether positioning in all areas makes sense. For example, why would customers buy something that tastes great with low nutritional value, when Brand 1 offers great taste AND higher nutritional value. In some cases, market gaps may exist because they don’t make sense to pursue. That said, in the above graph, there may still be a positioning opportunity to provide a product offering great taste and even higher nutritional value than Brand 1.

Note: Great marketers will often create multiple perceptual maps to understand audience preferences across multiple variables and to get a more wholistic view of the market and market gaps.

Key Takeaways

- The core elements of the STP framework are segmentation, targeting and positioning
- STP is an excellent framework to identify and define your target market, audiences, and how you plan to differentiate your products or services from the competition.

Exercises

Here is a segmentation exercise from Great Ideas for Teaching Marketing:⁵

Segmentation Rules

1. You need to create three segments each time only.
2. You must have at least two consumers in each segment.
3. The consumers in the segment must have one or more things in common (based upon their characteristics).

Create Three Segments for These Consumers

Person	Age	Where They Live	Marital Status	Social Class	Loyalty to Brands	Price Sensitivity	Lifestyle	Benefit Sought
1	19	Rural	Single	Lower	Low	Medium	Family	Best value
2	47	Suburbs	Married	Lower	Low	High	Social	Best price
3	66	Suburbs	Married	Middle	Low	High	Social	Best price
4	23	Rural	Married + children	Middle	Low	High	Family	Best price
5	64	Rural	Married + children	Lower	Medium	Medium	Family	Best value
6	25	City	Single	Middle	Medium	Medium	Sporty	Best quality
7	35	Suburbs	Single	Middle	Medium	Medium	Travel	Best value
8	50	Suburbs	Married + children	Upper	Medium	High	Family	Best price
9	36	Suburbs	Married + children	Middle	High	Low	Sporty	Best quality
10	50	City	Married	Middle	High	Medium	Travel	Best quality
11	53	Suburbs	Single	Upper	High	Low	Travel	Best quality
12	70	City	Married	Upper	High	Low	Sporty	Best value

Discussion Questions

1. There are eight characteristics for each consumer. Two are psychographic/lifestyle variables, three are behavioural variables, and three are geographic/demographic variables. Start by identifying which variables are in each of these categories.
2. Identify three market segments, using:
 - A. Psychographic/lifestyle variables as the segmentation base/s
 - B. Behavioural variables as the segmentation base/s
 - C. Geographic and/or demographic variables as the segmentation base/s
3. For each approach, how would you define each of your segments? That is, create a brief segment profile for each segment. (Note: You should have nine segments – 3 X the three approaches.)
4. Choose the segmentation approach that you think works best for these consumers (this market). That is, the best approach in this market is... psychographic, behavioural, OR geographic/demographic? Why?

5. How Would You Segment These Consumers? (<https://www.greatideasforteachingmarketing.com/how-would-you-segment-these-consumers/>)

Image Descriptions

()Flow of the STP Process Image Description

1. **Customer Segmentation:** Determine the important characteristics of each customer segment.
2. **Customer Targeting:**
 - Evaluate potential and commercial attractiveness of each customer segment.
 - Select one or more segments.
3. **Positioning:**
 - Develop detail product or service positioning for each segment.
 - Develop a marketing and customer strategy for each segment.

Return to the Flow of the STP Process Image (#retstpprocess)

Media Attributions

- STP framework by Rochelle Grayson is licensed under a CC BY 4.0 licence.
- STP process by Rochelle Grayson is licensed under a CC BY 4.0 licence.
- Segmentation, Targeting and Positioning – Learn Customer Analytics (https://www.youtube.com/watch?v=Fij1aBcl_Ts) by 365 Data Science (<https://www.youtube.com/c/365DataScience>) is under a Standard YouTube License.
- Marketing Mix – Learn Customer Analytics (<https://www.youtube.com/watch?v=p6OIJ3EB4Q&t=110s>) by 365 Data Science (<https://www.youtube.com/c/365DataScience>) is under a Standard YouTube License.
- STP -customer perspective by Rochelle Grayson is licensed under a CC BY 4.0 licence.
- Customer or market segmentation by Rochelle Grayson is licensed under a CC BY 4.0 licence.
- Targeting by Rochelle Grayson is licensed under a CC BY 4.0 licence.
- Positioning by Rochelle Grayson is licensed under a CC BY 4.0 licence.
- Positioning/perceptual map by Rochelle Grayson is licensed under a CC BY 4.0 licence.
- Positioning map – brands by Rochelle Grayson is licensed under a CC BY 4.0 licence.

6.

Customer Personas

Learning Objectives

By the end of this chapter, you should be able to:

- **Define** what a customer / buyer persona is
- **Explain** the key steps in developing data-driven customer personas
- **Describe** internal and external data sources used to develop customer personas
- **Analyze** a data-driven customer persona
- **List** the pros and cons of customer personas

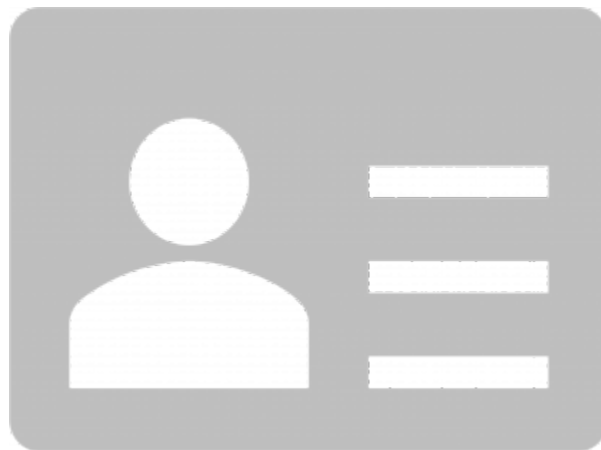

What is a Customer / Buyer Persona?

As we saw in the previous chapter, most marketing strategies and activities begin by asking: Who are our “customers” or “users”? Please note that when we use the term “customer” or “user”, we are referring to your target audience. For example, “customers” or “users” could be:

- Buyers of an organization’s product or service, or
- Donors for a fundraising non-profit organization, or
- Applicants for an educational institution, or
- Constituents for a federal or municipal government.

In this chapter, we will use the terms “customers”, “users”, and “target audience” interchangeably. Please feel free to substitute any specific definition that applies to your organization.

Assuming you have defined your target audiences, the next important step in developing an understanding of your key customers and target audiences is creating “data-driven customer personas”. Simply defined, **data-driven customer or buyer personas** are semi-fictional representations that showcase the key traits of a segment of your target audience, based on data you have collected from customer research and/or any other analytics platforms.

Here is a 9-minute video, **How To Create A User Persona** (<https://www.youtube.com/watch?v=DvV7ZcRVQ4g>), that provides a nice summary of what customer personas are, as well as walks you through the process of building your own:



One or more interactive elements has been excluded from this version of the text. You can view them online here: <https://opentextbc.ca/foundationsdigitalmarketing/?p=58#oembed-1> (#oembed-1)

If you are focused more on technical user design, user interfaces (UI), and user experience (UX), the following video, **How to Create UX Personas** (<https://www.youtube.com/watch?v=B23iWg0koi8>), provides yet another important perspective:



One or more interactive elements has been excluded from this version of the text. You can view them online here: <https://opentextbc.ca/foundationsdigitalmarketing/?p=58#oembed-2> (#oembed-2)

Now that you understand what customer personas are, let’s explore a few different types of customer personas.

Types of Customer Personas

There are a few different approaches to developing your customer personas:

- Data-driven and Proto/Ad hoc/Lean Customer Personas
- Initiatives-based vs. Close-up Customer Personas

Data-Driven vs. Proto / Adhoc / Lean Customer Personas

The main difference between “data-driven” customer personas and “proto, adhoc, or lean” customer personas has to do with how the personas are created. In an ideal world, you start with a blank sheet of paper, make no assumptions, and conduct extensive audience research. You talk to lots of real-world people and use the data collected to construct personas. This is the data-driven approach, and it is how personas should – **ideally** – be created.

That said, many organizations do not have the time, budget, or desire to do this level of research. So, rather than stall the customer persona process or have no personas at all, you can use a different approach: proto or ad hoc customer personas. This approach is described in detail in the book *Lean UX* by Jeff Gothelf and Josh Seiden, and as a result, these personas are sometimes also called lean personas.¹

Proto, adhoc, or lean personas normally are not created by doing extensive external audience research, but rather by collecting information primarily from within an organization. For example, you might hold a workshop or meeting with various stakeholders and ask them to *describe* your target audience. Based on everyone’s input and/or experience, you can start building some ‘rough’ personas.

The critical thing to note is that these rough personas are not research-led and therefore contain assumptions or biases that may or may not be true. While proto, adhoc, or lean personas can be useful tools, treat them with caution and verify them with research – even if that research happens well after you have created your rough personas. A good approach is to start with a few proto personas to get the process rolling and to get stakeholder buy-in. Then, over time, conduct research to verify and validate their accuracy and refine them as you gain more audience insights and gather more audience data.

High-level Segmentation vs. Initiatives-based vs. Close-up Customer Personas



Another way to approach your customer personas is by exploring how broad or narrow you want your customer personas to be. Below we present three common options along this spectrum.

- **High-level segmentation** provides marketers with a bird’s eye view of their target audience. Since there is limited segmentation, the data driving this type of persona is quite broad and this customer persona will represent the largest / broadest segment you may want to target. For organizations that have not created personas, this is a suggested first step. However, to ensure better targeting and maximize your marketing effect, it is recommended to further segment your target audience and create more defined and narrower customer personas as time and other resources permit.
- **Initiatives-based customer personas** identify groups of customers, who have a moderate to high interest in a specific initiative. These are often seen with cause-based non-profits, where the target audiences are particularly interested in a specific, cause-based initiative. These customer personas often represent a subset of the high-level segmentation target audience, but do not represent those audience segments at the lowest possible level(s).

1. Lean UX: Designing Great Products with Agile Teams Hardcover (<https://www.amazon.ca/Lean-UX-Designing-Great-Products-dp-1491953608/dp/1491953608/>)

- **Close-up customer personas** highlight customers, who are generally interested in a *specific* product, service, program, or action/activity. For example, close-up customer personas might represent “customers most likely to leave”. These customer personas tend to be narrower and as a result, represent a smaller audience segment. However, because of the narrow focus, these personas are easier to target and have more in common with other members of that audience segment.

Now that we’ve discussed several types of customer personas, let’s explore how to develop data-driven customer personas.

How to Build a Data-driven Customer Persona

Below is a framework that will cover all the foundational aspects of a customer persona. However, please keep in mind that all customer personas should incorporate multiple viewpoints, i.e., if a customer persona is being developed by a single person, with only one viewpoint in mind, for only one purpose, and/or for only one stage of your customer journey (more on this in the next chapter), your persona may not support your organization as a whole. As mentioned before, your customer persona should work for your product, marketing, sales, and customer success teams. So, try to include a variety of customer viewpoints in the following process because it will make your customer personas much stronger and applicable to the entire organization.

1. Conduct Customer Research

To get a deeper understanding of your target audience, start by seeking out the answers to the following questions:

- Who are your customers?
- How do they behave?
- What are they interested in?
- What kind of challenges do they face?

More specifically, here are several customer research data points that you may want to collect and document:

Customer Research Data Points

Category	Examples	Sources
Demographics/ Backstory	Name, birthplace, family history, childhood memories, first job, location, etc.	CRM, Public records, social media analytics
Personal life	Marital status, family size, pets, diet and fitness habits, etc.	Public records, social media
Career	Industry, job title, experience level, retirement plans, etc.	CRM, LinkedIn, online forums, Google
Personality traits	Introvert/extrovert, right brain/left brain, optimistic/pessimistic/etc.	Social media, customer surveys, interviews, List of 14 free personality tests, online comments ²
Online behaviour	Favorite social media platforms, search engines, mobile devices, etc.	Social media activities, online groups, forums, comments
Purchasing behaviour	Favorite online retailers, payment methods, spending habits, etc.	Google Analytics, Tag Manager, remarketing / retargeting tools, previous campaign analytics
Goals and challenges	Dream job, customer service experiences, regrettable purchases, etc.	CRM, customer service database, customer surveys, feedback, focus groups, online comments
Objections	Communication issues, product features, purchasing methods, etc.	CRM, customer support database, customer surveys, interviews, focus groups

For some more ideas, you may also want to consider **Hubspot's list of what you should consider when defining buyer personas.**³

2. Identify Customer Pain Points

Either through customer surveys, interviews, or social listening, you will want to identify the key pain points your customers have, e.g.:

- What problems or hassles are they trying to solve?
- What's holding them back from success?
- What barriers do they face in reaching their goals?

2. 14 Free Personality Tests That'll Help You Figure Yourself Out (<https://www.themuse.com/advice/14-free-personality-tests-thatll-help-you-figure-yourself-out>)

3. 20 Questions to Ask When Creating Buyer Personas [Free Template] (<https://blog.hubspot.com/marketing/buyer-persona-questions>)

3. **Identify Customer Goals**

This is the flip side of pain points. Pain points are problems your potential customers are trying to solve. Goals or aspirations are positive things they want to achieve. Depending on the kinds of products and services you offer, these goals might be personal or professional. Similar to above, this information can be acquired through customer surveys, interviews, or social listening.

4. **Understand How You Can Help**

Now that you understand your customers' pain points and goals, it's time to create a really clear picture of how your products and services can help. Stop thinking about your brand in terms of features and dig deep to analyze the benefits you offer to customers. Consider your products and services from a customer's point of view. And, keep in mind the following three questions:

- How can we help?
- What are your audience's main purchasing barriers?
- How can you help customers overcome any barriers / pain points and achieve their goals?

5. **Define and Name Your Customer Personas**

Define and name these customer segments. Start looking for common characteristics and patterns. As you group those characteristics together, you'll have the basis for your unique customer personas. Take your collection of characteristics and turn them into a persona that you can identify with and speak to. Give your customer persona a name, a job title, a home, and other defining characteristics. You want your persona to seem like a real person.

Customer Persona Analysis Exercises

Let's look at a few sample customer personas ...

Tanvi Kaur



"Marketing is the perfect blend of creative and analytical activities."

Age: 27

Work: Marketing Manager

Marital Status: Single

Location: Calgary, AB

Character: Mentor

Personality



CREATIVE

ANALYTICAL

COLLABORATIVE

Goals

- Increase lead quality
- Increase positive brand reviews
- Improve brand awareness and customer demand

Frustrations

- Lack of appropriate customer data
- Understaffed marketing team
- Limited marketing budget

What I look for in software

- Intuitive and easy-to-use administration tools
- Works well and is cost-effective for smaller teams
- Integrates with Hubspot and/or Adobe products

Bio

Having worked for both startups and large tech companies, I have spent my career planning, developing, and implementing marketing strategies to drive sales. I have managed social media accounts and websites to engage existing customers and establish positive public relations. Partnering with our technical teams, I have implemented search engine optimization (SEO) for our online media.

"I love working on new product launches and conducting market research to reach new markets and audiences. I am happiest when my team delivers engaging and impactful campaigns that deliver positive ROI."

Motivation

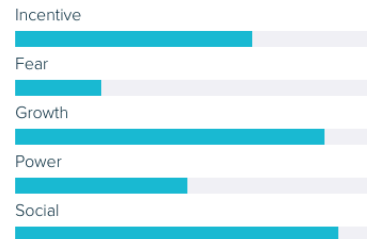

Brands & Influencers



Preferred Channels

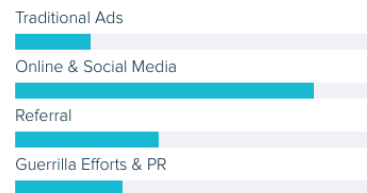

Here we have Marketing Manager, Tanvi Kaur, a business-to-business (B2B) persona. We can see her goals and aspirations, and even the experience she's seeking when looking for products and services. It's interesting that we also have a mix of bulleted statements, as well as quotes from Tanvi herself. It's beneficial to let your personas speak for themselves. This little touch goes a long way towards showing the individual's personality and can also provide cues to the type of language the persona uses and what messaging might resonate with them.

Looking at Tanvi's customer persona above, how would you answer the following questions:

1. **What additional details might be useful for this customer persona?**
2. **If you were a software company, how might you target Tanvi?**

Here we have John Pulman, a business-to-consumer (B2C) customer persona:



“I love to meet new people, they share their fascinating stories and ideas. After meeting someone new I get a lot of inspiration. I feel there should be an app for a casual meeting with strangers.”

Bio

John is a part-time editor for a lifestyle magazine in Beijing. He came with his Chinese wife and stayed after the divorce. John loves new places, he often visits bars and restaurants that just opened in the city. In his free time, he is writing a post-apocalyptic science fiction book.

Goals · Interest

- ◆ Find new friends in a foreign city.
- ◆ John is not interested in new relationships, because not long ago he went through a divorce.
- ◆ He is also not that much interested in a hook-up with some stranger.
- ◆ John is looking to meet someone just for fun, to go to cinema or go for a lunch, talk, travel.
- ◆ John also travels a lot, but usually alone and rarely meets new friends because he is a little shy to approach people.

Pain Points · Concerns

- ◆ Dating apps that John tried doesn't have the right people.
- ◆ Some online websites that are used to find a relationship are also not suitable for him.
- ◆ Even when he found some interesting people online it took him weeks in chatting before he actually met them in person.
- ◆ When John travelled to Cambodia last time, he tried some solo travelling apps, he posted some messages and liked some profiles but people answered when he already left the country.

Motivations

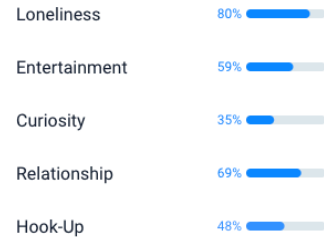

Technology



Personality

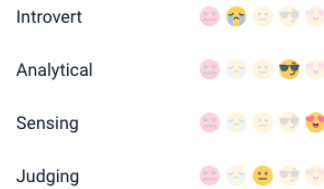

Brands



Who knew that a writer could be so well defined? This persona provides a great example of digging deep to fully understand your customers. Not only do we get a glimpse into John's life, background and interests, we also get to know him in terms of pain points and concerns. His influences and brand affinities are an important inclusion as well, as these can provide critical cues for messaging and interactions.

Once again, here are some questions related to John:

1. **What other information might you include in a B2C customer persona?**
2. **Besides dating apps, what types of companies might be interested in having John as their customer?**

Pros and Cons of Customer Personas

Customer personas can be an important strategic and tactical tool. However, it is helpful to review some of the common pros and cons.

Cons

- **Significant Time and Effort**

To be done well (and correctly!), customer personas take time and effort. Organizations may not want to (or be able to) invest the necessary time to create truly *data-driven* customer personas. As a result, customer personas may be based on customer “aspirations” or customer stereotypes instead of *observed* behaviours or properly researched customer data; this can defeat the purpose of customer personas being objective representations of a customer group. To avoid this, consider the realities of the effort and ensure proper allocation of resources for customer research.

- **Poor Research Practices**

Those conducting the customer research may not have advanced research skills. Given that data-driven customer personas are based on data and the research collected, the personas may be built on faulty, inadequate, or biased data. Naturally, all of these “mistakes” will cascade through your personas. Ideally, you should hire professional researchers for this purpose and develop personas based on their extensive research data. That said, many organizations may not be willing / able to commit these kinds of resources to this task. Therefore, it is recommended to use a combination of primary and secondary research to ensure that your customer personas are not just based on data collected *exclusively* by your organization, but also incorporate data collected by third parties. Along these lines, cite all your sources, both internally and externally, so that if you discover any research bias, you can quickly update your data models and update your customer personas accordingly.

- **Just Fictional Stories**

Some argue that personas are all made up of stories and our perceptions. In the past, this statement may have been true. However, with the amount of data available to organizations today, customer personas can be based on observed data and reflect the reality of what is happening. That said, do be careful in how *interpretations* of the data can enter into customer personas. Try to make sure personas are based on real data. Even then, consider personas as supportive data and not the only source of customer insights. This is why customer personas require testing, validation, and updating because with an iterative approach, you can identify false assumptions or interpretations built into your personas.

- **Outdated**

Because changes are happening quickly, some people will argue that customer personas are outdated. Like most strategic and tactical tools today, it is critical that you do not just create customer personas and leave them. Use them to guide your organizational strategies and activities. But, also try to measure real-time data as much as possible to see if your personas match the customers you are attracting and engaging with. If not, there is a mismatch, and your customer personas need to be updated. Remember the customer persona process is

circular. Customer personas are living documents.

Pros

Customer personas assist marketers in knowing what to promote, to whom, when, and through which marketing channels. With digital marketing on the rise and more and more marketing channels available to marketers, making sure you spend your time and money on the appropriate marketing channels and activities can define your organization's success or failure.

In this article, **What is a 'Buyer Persona' and Why is it Important?**

(<https://www.socialmediatoday.com/news/what-is-a-buyer-persona-and-why-is-it-important/507404/>), there is a list of areas across your organization where customer personas can guide the direction of your work, for example:

- **Product or Service Development**
Product development can use customer personas to help guide and build product or service roadmaps.
- **Marketing Strategies & Activities**
Marketing can use customer personas to build effective strategies and also identify and prioritize marketing activities.
- **Sales Prospecting & Sales Calls**
Customer personas can help your sales team build rapport with potential customers by understanding what they want and being prepared to address their concerns.
- **Customer Support**
Customer support teams can use personas to better serve your customers by being trained on the problems your customers are trying to solve with your product or service.
- **Designers**
Designers can use user experience (UX) / user interface (UI) personas to develop and test useful and understandable visual customer experiences that support an organization's conversion strategies and goals.
- **Competitive Intelligence**
Generate personas for competitors and discover trends as they happen. As a result, you may be able to uncover content, advertising, and partnership opportunities/strategies.

Please note that any tool and any type of market research can result in faulty insights. The key is to choose the proper tool and use it correctly. Bottom line: the identified issues are not inherent flaws in personas, but rather flaws in **implementing** personas. These flaws can be fixed by proper management, real customer data, and regular updating of personas.

Hopefully, you can see how powerful customer personas can be as a marketing and organizational tool. Knowing how to analyze and create your own customer personas can be important, especially as organizations experiment and try to connect with new target audiences. That said, do try, as much as possible, to develop your customer personas based on data and solid customer research!

Key Takeaways

Customer personas are important strategic and tactical tools that supports many of your digital marketing strategies and activities.

- Data-driven customer or buyer personas are semi-fictional representations that showcase the key traits of a segment of your target audience, based on data you have collected from customer research and/or analytics.
- To Build a Data-driven Customer Persona:
 1. Conduct Customer Research
 2. Identify Customer Pain Points
 3. Identify Customer Goals
 4. Understand How You Can Help
 5. Define and Name Your Customer Personas

Customer Persona Tools & Resources

Here are few online tools that you can use to easily create a visual customer persona:

- Hubspot's Make My Persona (<https://www.hubspot.com/make-my-persona>)
Hubspot's persona generator is a step-by-step wizard that will walk you through the process of creating a useful customer persona for your organization. A nice touch is that it allows you assign photos to your personas as well as names. It is focused on professional clients and customers, or business to business (B2B) use. Expect to be asked for information regarding not only their job title and career goals, but also the tools they use at work, who they report to, and who reports to them. This won't be necessary information for everyone who wants a buyer persona, but some will be delighted by this. Again, this requires you to use the tool with data you've segmented elsewhere and simply input that data.
- User Forge (<https://userforge.com/>)
User Forge gives you more freedom to create your own criteria than other persona generators. If you know what's important to your marketing efforts in terms of segmenting your audience, then this might be the one for you. Create quotes, blocks of text, and lists to help you and your colleagues narrow down your ideal customers and focus your marketing efforts.
- Xtensio (<https://xtensio.com/>)
This is a free tool that has an attractive and easy-to-use persona template. This is primarily about designing your customer persona, i.e., you will still need to complete your data analyses elsewhere.
- Smaply (<https://www.smaply.com/>)
Smaply gives you the tools to visualize your entire customer experience by creating personas, stakeholder maps, and journey maps (again, we'll discuss this more in Module 3). The combination of persona creator and stakeholder and journey maps is very useful. You can describe the steps that a customer takes before purchasing a product or using a service. And you can include the factors that influence their decisions and actions. This exploration can really help an organization get a handle on customers' wants and needs.
- Flow Mapp (<https://www.flowmapp.com/>)
Similar to Smaply, Flow Mapp allows you to create customer personas and customer journeys using the same tool. They offer a very easy-to-use, design editor with drag-and-drop content blocks, which makes creating and updating personas and customer journeys quite easy. As an extra bonus, you can also use Flow Mapp's online collaborative tools to design your websites and apps.

Media Attributions

- How To Create A User Persona (Video Guide) (<https://www.youtube.com/watch?v=DvV7ZcRVQ4g>) by CareerFoundry (<https://www.youtube.com/user/careerfoundry>) is under a Standard YouTube License.
- How To Create UX Personas (<https://www.youtube.com/watch?v=B23iWg0koi8>) by UX Mastery (<https://www.youtube.com/c/uxmastery>) is under a Standard YouTube License.
- High-level Segmentation vs Initiatives-based vs Close-up Customer Personas by Rochelle Grayson is licensed under a CC BY 4.0 licence.
- Tanvi Kaur B2B Customer Persona by Rochelle Grayson is licensed under a CC BY 4.0 licence.
- John Pulman customer persona by Rochelle Grayson is licensed under a CC BY 4.0 licence.

7.

Customer Journey Mapping

Learning Objectives

By the end of this chapter, you will be able to:

- **Explain** what a customer journey is
- **Develop** insights across the entire customer journey / lifecycle
- **Describe** the benefits of a customer journey

Customer Journey Map - Example



What is a Customer Journey Map?

In our customer-centric world, providing a superior customer experience (CX) is a priority for any organization pursuing real success. Today's organizations are doing everything they can to better understand their customers. Whether your brand is business-to-business (B2B) or business-to-consumer (B2C); a start-up or corporation; global or local, providing exceptional customer experience is a must. One of the best ways to get to know your target audience is by walking in their shoes and mapping each and every interaction you share. This is where the customer journey map comes in.

A **customer journey map** is a visualization of an end-to-end customer experience. It's essentially a visual narrative that allows you to understand each process your customer encounters with your organization, spanning each step from their initial engagement to, hopefully, a long-term relationship. As Matthew Fairweather, director of Matthew Fairweather Ltd., has stated:

Customer journey mapping is really a mixture of art and insight ... But that's just a visual aid. The real work in journey mapping is using all of the customer information and data available to you from across the business and delivering a process and structure to their experience.

A great customer journey map should highlight how your customers discover, research, purchase, interact, and even promote your offerings. One of the easiest places to start is by outlining all the touch points your organizations has with its target audience. In the graphic below, the touch points are listed in the boxes and represent customer interactions as they move through each of the stages. And, as you can see, these touch points can be either online or offline.

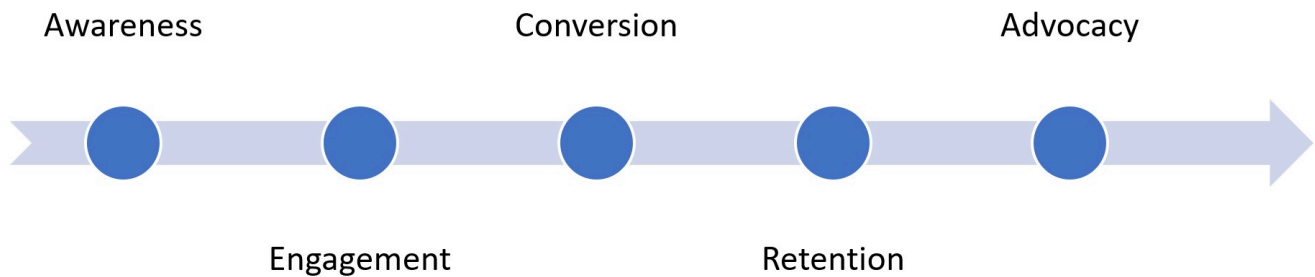

Touch Points at Various Stages in the Customer's Journey

Stage	Touch Points
Awareness	<ul style="list-style-type: none"> • Paid ads (online and offline) • Radio/TV/print/outdoor ads • Email/direct mail • Promotions, sales, coupons • Word-of-mouth • Events (online and offline)
Engagement	<ul style="list-style-type: none"> • Website • Blog • Social media • Retail store • Salesforce/call centre • Events (online and offline)
Conversion	<ul style="list-style-type: none"> • Website/eCommerce shop • Social (media) commerce • Retail store • Demo call/salesperson • Online chat/IM • Customer success reps
Retention	<ul style="list-style-type: none"> • Training materials • Support portal • Customer success reps • Tech support reps • Online chat/IM • Social media support

<p>Advocacy</p>	<ul style="list-style-type: none"> • Newsletters (online and offline) • Loyalty and incentive programs • Community forums • Events (online and offline) • Endorsements • Social media shares/reviews
-----------------	--

Simply stated, a customer journey usually includes the following five stages:

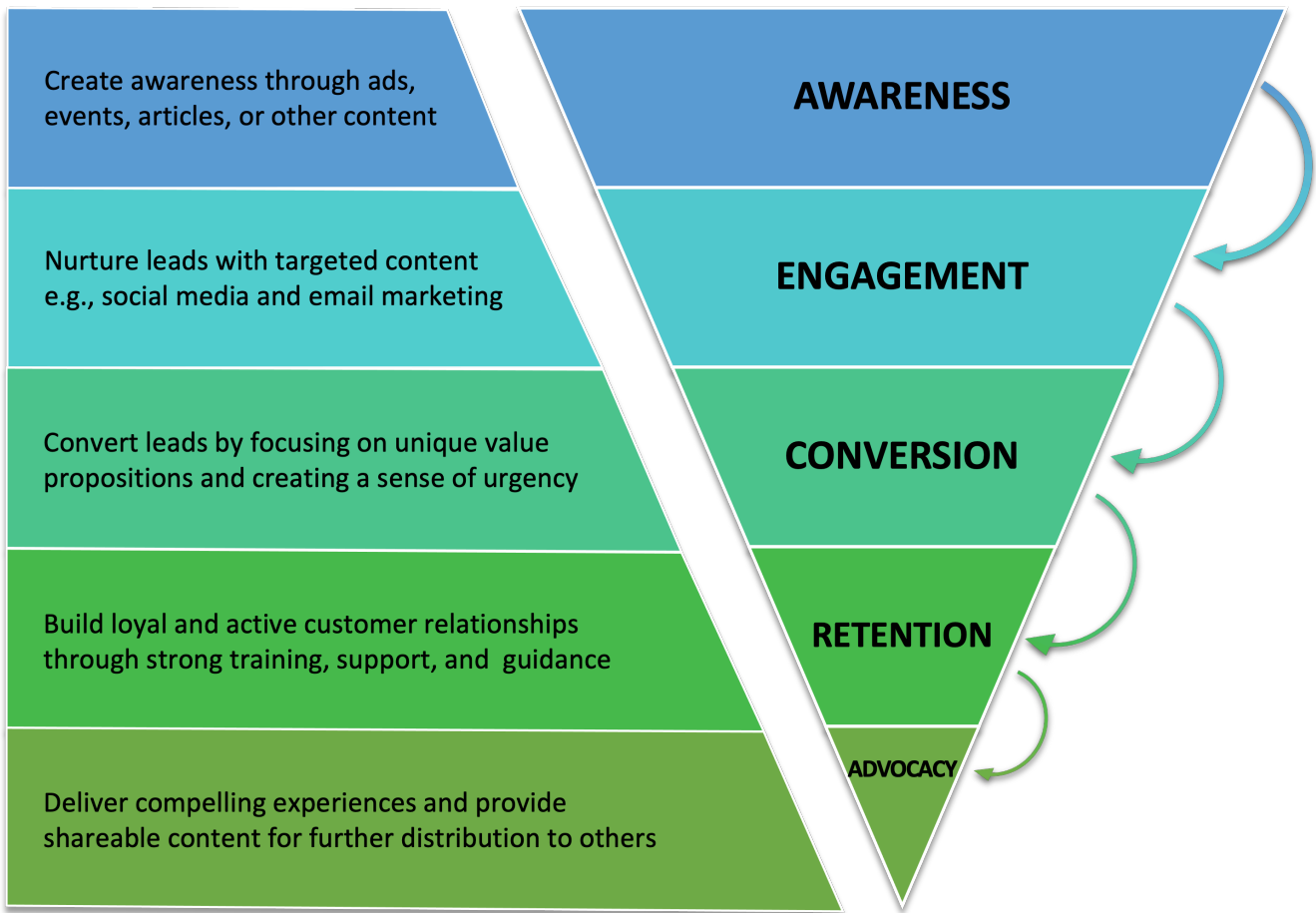

1. **Awareness**

A prospective customer learns about an organization, product, or service. In this initial stage, marketers create awareness through ads, events, articles, or other content

2. **Engagement**

A relationship develops between the prospective customer and the organization via several, positive interactions. This is achieved by nurturing leads with targeted content., e.g., on social media, through email marketings, or other events / owned media.

3. **Conversion**

The prospective customer decides to buy a product or service from the organization. By

presenting a unique value proposition and creating a sense of urgency, e.g., special offers, marketers can help prospective customers convert.

4. **Retention**

The customer has a strong and loyal relationship with the organization and becomes a regular customer or active user. While often the domain of customer support or customer success, marketers can assist by providing the appropriate training materials, support, and resources to ensure customers are satisfied and stay.

5. **Advocacy**

A regular customer is satisfied with the organization's products and/or services and recommends them to others. To create advocates, organizations must deliver compelling experiences worthy of sharing. To support these experiences, marketers can provide ready-to-share content.

Please note that depending on your organization, you may choose to rename some of the stages from above or perhaps even break up a stage into multiple stages. For example, if you are in HR and mapping the "customer journey" for recruiting new employees, "Conversion" could be changed to "Application Submitted" and "Engagement" might be broken up into First interview, Second Interview, etc. So, feel free to tweak the *specific* names and number of stages to best fit your organizational processes. But do make sure that you are capturing all the steps in your target audience's journey.

In addition to specific stages and touchpoints, a great customer journey map also includes additional information and details. Here are six more areas to consider when building a comprehensive customer journey map:

1. **Customer's Perspective**

When you build your customer journey map, ensure that you are mapping and presenting everything truly from the customer's perspective. This is a great opportunity to use the **customer personas** that you have created to closely map out their customer journeys. Organize the stages to reflect the conversion process from your customer's (or customer persona's) perspective, as opposed to your own internal processes. This can often include aspects out of your direct control, such as social media influences, web searches, and steps your customers take even before you enter the picture.

2. **Customer's Thoughts, Emotions, Pain Points, and Goals**

For every stage of your customer journey map, write out what your customers are thinking, contemplating, feeling (even fearing), struggling with, and what they hope to accomplish. This will help you, as an organization, meet and address those specific needs. Here are a few examples:

1. **Customer Thoughts**

Customer thoughts represent what customers are thinking at a specific stage of their customer journey. Examples include:

- I hope I can find _____?
- Is this organization credible?
- How do I use _____?

- Is there support post-purchase?
- How does ____ compare to other offerings in the market?
- How much does it cost?
- How long will it take to get it?

2. Customer Feelings

Customer feelings reflect what customers might be feeling at a specific stage of their customer journey. Examples include:

- Excited – often at the beginning when a “solution” is a possibility
- Curious – usually at some point when doing research or trying to find out more information
- Confused – for complex or complicated products / services
- Hopeful – perhaps after purchase, but before using the product / service
- Impressed – post-purchase
- Frustrated – when things go wrong
- Overwhelmed – too much information

(For visualization purposes, emotions are sometimes represented by emojis.)

3. Customer Pain Points

Customer pain points are specific problems that prospective or existing customers are experiencing at a specific stage in their customer journey. Examples include:

- ____ takes too much time. (process pain point)
- ____ is too complex and I don't understand how to use it. (product/service pain point)
- I can't find the information I need. (accessibility pain point)
- I can't connect with the appropriate person. (support pain point)
- It's too expensive. (financial pain point)

4. Customer Goals

Customer goals highlight what a customer is looking to accomplish at a specific stage of their customer journey. Examples include:

- I want to find out how much it costs.
- I want to solve “this” problem.
- I want to learn about ____.
- I want to buy ____

3. Customer Activities

What does the customer actually do at every step along the customer journey?

4. **Content**

As you review each stage of your customer journey, think about what content (articles, FAQs, video, white papers, videos, training materials, etc.) you need to provide to address the customer's issues.

5. **Time**

The length of a customer experience provides important context. Does a typical stage last minutes, days, weeks, or months? How long does your customer remain in a specific stage? A great journey map recognizes that this information is essential and takes time into consideration.

6. **Key Performance Indicators (KPIs) / Data Collected**

At each stage, the organization should think about what data it will collect, measure, evaluate. What are the key performance indicators (KPIs) that show the organization is performing well (or not) in meeting the target audience's needs at that *specific* stage? Often organizations will focus on high-level KPIs and outcomes, but by creating KPIs for each stage, an organization can better identify where in the customer journey things are either performing well or not.

7. **Opportunities**

Once mapped out, where are the gaps and the possibilities? The main purpose of any customer journey map is to improve your customers' experiences and satisfaction. Given all of the above considerations, where is there room for improvement or new opportunities?

If you want to see some very good, visual examples, please read the following articles, **Nine Sample Customer Journey Maps – And What We Can Learn from Them** (<https://www.mycustomer.com/customer-experience/engagement/nine-sample-customer-journey-maps-and-what-we-can-learn-from-them>) and **144 Best Customer Journey Map Templates and Examples** (<https://www.userinterviews.com/blog/best-customer-journey-map-templates-examples>).

Hopefully, you now have a better understanding of customer journeys. To better complete your customer personas and customer journeys, you will need to collect and analyze lots of data about your customers. This customer research is **critical** to the accuracy, precision, and validity of these tools. While the goal of these tools is to improve the customer experience and to make better customer-focused decisions, if the underlying data is not appropriate, recent, and/or accurate, your entire analysis may be flawed. So, if you are planning to use customer personas and customer journey maps as a strategic, decision-making tool, do make sure you have the appropriate data to support it.

Here is a YouTube video (6 mins), **Customer Journey Map Workshop** (<https://youtu.be/X7iXcP-wlkk>), that does a nice job explaining how data, customer personas, and customer journeys work together:



One or more interactive elements has been excluded from this version of the text. You can view them online here: <https://opentextbc.ca/foundationdigitalmarketing/?p=64#oembed-1> (#oembed-1)

Benefits of a Mapped Customer Journey

Now that you have a more detailed understanding of what a customer journey is and how to track customers as they move through their customer journeys, let's talk about **why** you should map the customer journey:

- **Consistency of touchpoints across the entire organization**
Similar to the customer persona, customer journeys are a valuable tool in understanding your customers and the various touch points across the **entire** organization. Customer journeys provide a holistic view of your customers and also highlight how the various departments and teams can work together to create a more seamless customer experience. Furthermore, organizations can use a customer journey to ensure consistency across the entire customer journey and a more consistent customer experience.
- **Deeper understanding of customers**
As mentioned previously, your customer journey should include your customer needs, wants, pain points, and preferences at each specific stage of the journey. By identifying these characteristics, organizations can better provide support, content, and services to address these very needs, wants, pain points, and preferences.
- **Closer and stronger customer relationships**
Organizations with detailed customer journeys tend to develop closer and more meaningful customer relationships because they know exactly what customers need, when they need it, and where / how they need it. This level of personalization and customer care translates into more loyal customers and ones that often turn into brand advocates.
- **Tailored and timely communications**
From a marketing communications perspective, knowing what to communicate, when to communicate it, and through which specific channels ensures that marketers are optimizing their return on marketing activities and investments. These activities deliver more personalized and targeted messaging, which can resonate more with target audiences and customer personas.
- **More targeted product development**
As we mentioned, customer journeys are also a great tool in identifying product or service development opportunities. For these development teams, customer journeys can identify areas where an organization might introduce new products and/or new ways to improve existing products and services to better serve your target audiences. In other words, customer journeys are not just about marketing but about the overarching organizational customer experience.
- **Improved identification of cross and up-selling opportunities**
From a sales perspective, customer journey maps identify those opportunities to create cross and up-selling opportunities that are complementary. Remember that this should not be the sole focus of your customer journey. However, there are times when complementary products or services will significantly improve the customer experience. Customer journey maps can serve as strategic tools in uncovering these opportunities.

Customer Journey Optimization

While customer journey maps are helpful in identifying new opportunities, they also allow organizations to quickly identify areas to optimize and/or automate processes or communications based on the data. In building your customer journey maps, it is critical to think about the key data that you will collect along the journey and how that data can help in making better organizational decisions. In other words, your customer journey map should always include the key data and analytics that you plan to collect and evaluate at each stage of your journey. By closely analyzing customer journey data, organizations can better assess how customers move from one touchpoint to another and how to make incremental improvements to the customer journey and customer experience.

Key Takeaways

A customer journey map is both a discovery and strategic organizational tool. In developing a customer journey map, organizations may discover areas that need improvement or can be supported better. However, a customer journey map can also be used to prioritize which target audiences to pursue or serve better.

- A customer journey map is a visualization of an end-to-end customer experience.
- A customer journey map covers the customer experience across multiple stages, from awareness through to advocacy. It does not stop at the point of conversion, e.g., purchase.
- For *each* stage, a customer journey map should include the following:
 - Customer's Perspective
 - Customer's Thoughts, Emotions, Pain Points, and Goals
 - Customer Activities
 - Content
 - Time
 - KPIs & Data Collected
 - Opportunities
- Not only can mapping the customer journey improve sales, it should also improve the overall customer experience leading to happier and more loyal customers.

Customer Journey Online Tools & Articles

Here are some articles and online tools for developing your customer journey:

- **Nine Sample Customer Journey Maps – And What We Can Learn from Them** (<https://www.mycustomer.com/customer-experience/engagement/nine-sample-customer-journey-maps-and-what-we-can-learn-from-them>)
- **144 Best Customer Journey Map Templates and Examples** (<https://www.userinterviews.com/blog/best-customer-journey-map-templates-examples>)
- **25 Tools to Create Stunning Customer Journey Maps (Templates Included)** (<https://www.userinterviews.com/blog/tools-for-customer-journey-mapping>)

Depending on your needs and complexities of your customer journeys, there are several ways to map your customer journey. Here are a few examples and options:

- **Whiteboards and Post-Its**

Sometimes the easiest and simplest option is to get everyone together in a room and use a whiteboard and post-its to brainstorm and map out a customer journey. The Post-Its allow you move ideas around and can make creating a first version much easier. If you want to do something online / virtually, there are many free online whiteboard and collaboration tools such as **Padlet** (<https://padlet.com/>), **Miro** (<https://miro.com/>), **Lucidspark** (<https://lucidspark.com/>), and **Ayoa** (<https://www.ayoa.com/>) that allow groups to perform activities like these online.

- **Excel or PowerPoint Templates**

Depending on how much real-time collaboration you want, you can also create customer journeys simply using Excel or PowerPoint. There are websites that will sell you inexpensive PPT templates or you can simply search for free customer journey templates online. That said, here is an Excel customer journey template (<https://opentextbc.ca/accessibilitytoolkit/wp-content/uploads/sites/388/2022/01/Customer-Journey-Template.xlsx>) as a starting point.

- **Online Customer Journey Mapping Tools & Technologies**

As mentioned in our **Customer Persona Chapter**, there are several online services like **Smapply** (<https://www.smapply.com/>) and **Flow Mapp** (<https://www.flowmapp.com/>). If you are looking for tools that can incorporate data from other databases / services and apply machine learning to that data, check out Mnemonic AI, and Delve AI (<https://www.delve.ai/>), which combine customer personas with the customer journey mapping process:¹

- **Mnemonic AI** (<https://mnemonic.ai/>)

Mnemonic AI analyses publicly available data and internal data and extracts the crucial insights to generate personas for your product, service, or organization. Mnemonic AI can import your internal data such as surveys, interviews, CRM, email analytics, web analytics, and call logs, as well as leverage external data such as social media, reviews, and third party research.

- **Delve AI** (<https://www.delve.ai/>)

Create data-driven personas and customer journeys for your organization using your Google Analytics data. Delve AI also offers competitor personas and a variety of B2C and B2B industry-specific comparisons.

Media Attributions

- Customer journey map – example by Rochelle Grayson is licensed under a CC BY 4.0 licence.
- Customer Journey Map Workshop (<https://www.youtube.com/watch?v=X7iXcP-wIkk>) by PlaybookUX (<https://www.youtube.com/c/PlaybookUX>) is under a Standard YouTube License.
- Customer journey touchpoints by Rochelle Grayson is licensed under a CC BY 4.0 licence.
- Conversion funnel with descriptions by Rochelle Grayson is licensed under a CC BY 4.0 licence.

1. Persona Creation. Automated. AI powered. (<https://mnemonic.ai/>)

II

Generating Customer Demand and Nurturing Leads & Prospects



Congratulations on completing the first section of the textbook and learning about several foundational concepts, strategies, and tools related to digital marketing. As mentioned before, this textbook is divided into three core sections:

- I. Fundamentals in Digital Marketing
- II. Generating Customer Demand and Nurturing Leads & Prospects
- III. Analyzing Your Digital Marketing Performance

In this next section, we will build on those foundations and focus on specific strategies and channels to generate customer demand and nurture prospective and existing customers. To achieve this, we will first introduce a lead generation framework and then dive into specific strategies, considerations, and best practices for:

- content marketing,
- search engine optimization,
- website and landing page optimization,
- paid advertising and search engine marketing,
- social media marketing,
- mobile marketing, and

- email marketing.

Media Attributions

- Digital marketing textbook structure by Rochelle Grayson is licensed under a CC BY 4.0 licence.

8.

A Lead Generation Framework

Learning Objectives

By the end of this chapter, you should be able to:

- **Explain** various types of leads and lead generation
- **Describe** the key elements of a 5-Step Lead Generation Framework
- **Provide** examples of how to apply a lead generation strategy

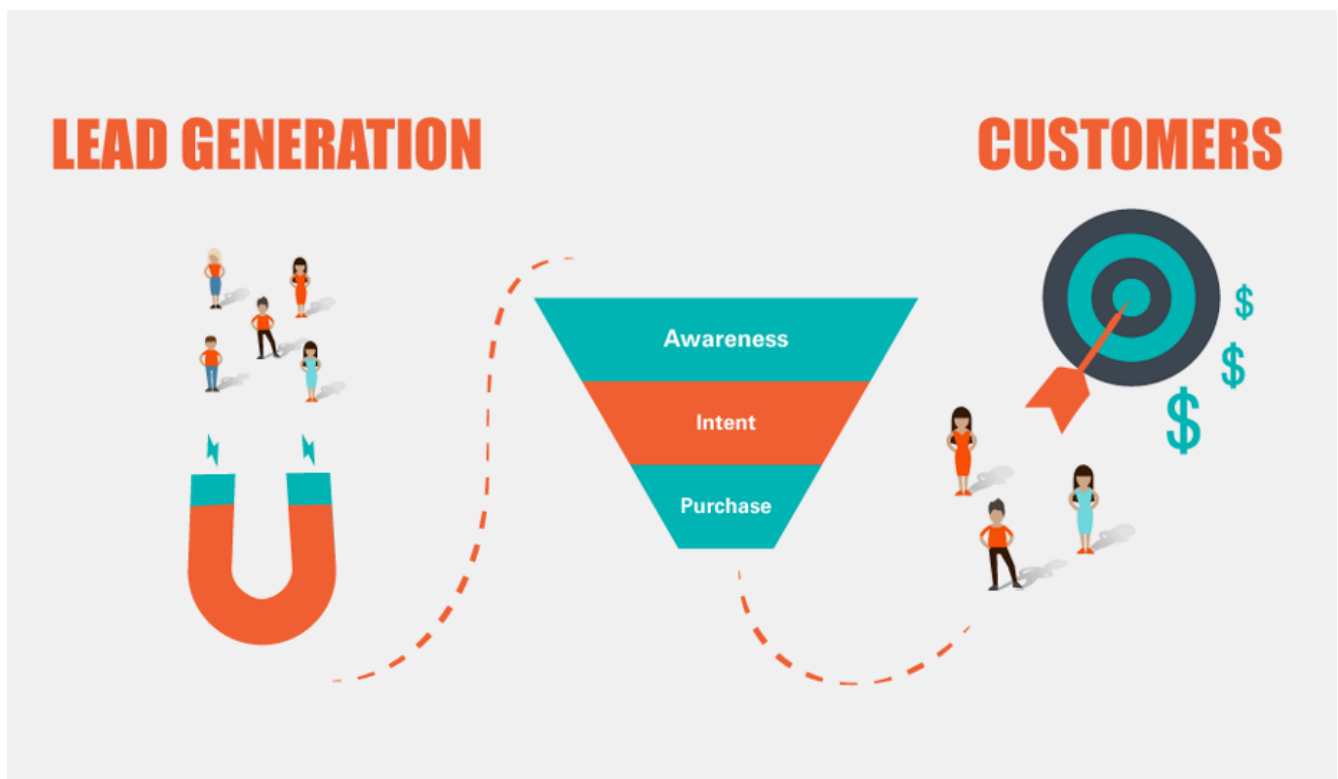

Now, that you understand a variety of digital marketing fundamentals, let's build on these concepts to generate customer interest, build strong relationships with prospective customers, and ultimately, drive conversions. In this chapter, we will introduce you to a lead generation framework that will outline how to:

- Conduct digital marketing outreach to attract potential customers

- Engage and connect with target audiences
- Nurture and convert prospective customers

What is a Lead?

To kick it off, let's begin by reviewing some fundamental concepts. A **lead** is any person who has shown some level of interest in an organization's product or service. Leads are usually triggered by a communication or marketing activity initiated by the organization. For example, if you have an email newsletter sign up form on your website, after submitting their contact information, a new subscriber would be considered a lead. Once an organization has this contact information, it can continue to communicate and send marketing messages to that lead and hopefully interest them enough to, ultimately, convert and buy.

There are a variety of ways to categorize leads:

- **Information Qualified Lead (IQL)**
Information qualified leads are contacts who randomly connect with the organization while searching for information. These contacts often share their contact details to get more information, e.g., to download a piece of content. After that, marketing teams can connect with them to share more relevant information to help close the deal.
- **Marketing Qualified Lead (MQL)**
Marketing qualified leads are contacts who have responded to marketing activities but have not explicitly expressed an interest in receiving a sales call. An example of an MQL is a someone who fills out a form on a landing page for a specific promotion or special offer.
- **Sales Qualified Lead (SQL)**
Sales qualified leads are contacts who have taken actions that explicitly indicate their interest in becoming a paying customer. An example of an SQL is a contact who fills out a form to book a demo or to get more information about your product or service.
- **Product Qualified Lead (PQL)**
Product qualified leads are contacts who have used your product and are interested in becoming a paying customer. A common example of PQLs is when organizations offer a free or limited trial of their product or service with the ability to upgrade to a paid premium version. In some cases, this upgrade might involve a sales team. But it could also apply when a trial customer simply asks about paid-only features.
- **Service Qualified Lead**
Sometimes an upgrade might happen as part of conversation with a customer service representative. When this happens, it can be referred to as a Service Qualified Lead, especially if it is not possible for the customer service representative to upgrade the customer and requires the involvement of the sales team.

As you can see from the above examples, there are many types of leads and most organizations will try to attract as many qualified leads as possible, which brings us to lead generation.

Lead generation is the process of getting leads or attracting and converting target audiences who have

shown an interest in your product or service. The following is a lead generation framework to help you identify, attract, nurture, and convert leads into paying customers.



The five steps in the 5-Step Lead Generation Framework are:

1. Define Your Target Audience
2. Set Your Organizational Goals & Objectives
3. Develop Content / Lead Magnets
4. Nurture & Close Your Leads
5. Get Customer Referrals

In the following chapters, we will dive deeper into key digital marketing tactics and activities that support this framework. However, in this chapter, we will first define and explain each of these key steps.

Step 1: Define Your Target Audience

As already discussed in the **Target Market and Audience**, **Customer Personas**, and **Customer Journey Mapping** chapters, a key component to any marketing strategy is clearly defining and identifying your target audience(s). Before starting any lead generation activities, make sure you have captured all the specific details and differentiators related to your target audiences. This will significantly help in focusing your marketing activities and knowing exactly where to spend your time, budgets, and organizational resources.

Let's first start with market segmentation, which we discussed in our **Target Market and Audience** chapter. Just to remind you, market segmentation refers to segmenting or grouping prospective buyers into different segments based on shared characteristics. These characteristics can include demographic, psychographic, geographic, or behavioural attributes.

Many of the attributes listed in the **Target Market and Audience** chapter can be easily applied to individual consumers. But, in the B2B space, market segmentation can look somewhat different. For example, segmenting your target audience might start by highlighting the following attributes for a target organization:

- **Industry**
Which specific industries are you targeting?
- **Location**
Are you targeting a specific geographic location?
- **Organization Size**
 - Size of revenues or net profits
 - Number of employees
- **Transactions**
 - ***Number of transactions***
Does the target organization have millions, hundreds, or tens of transactions per year?
 - ***Frequency of transactions***
Do your target customers have transactions daily, weekly, every six months, etc.?
What does ***their*** sales cycle look like, i.e., how long does it take ***them*** (not you!) to close a sale?
 - ***Value of transactions***
On average, how much is each transaction?
- **Usage**
Usage refers to usage of your service or your product
 - ***Heavy, medium, light***
Is your target customer's usage heavy, medium, or light? Do they use it once a month, every week, or every day?
 - ***Complementary products / services***
Are there any complementary products and services our customers tend to be using, e.g., ERP, MRP, accounting, payment, point-of-sale (POS) services that we should integrate with?
- **Time in Business**
How long have they been in business?

B2B Target Customer Examples

Here are two potential B2B target organization descriptions:

- Your target organization might be an organization with:
 - 10+ years in business,
 - in the technology industry,
 - in Canada,
 - with revenues over \$1 million,
 - with average transaction values between \$7,500 – \$15,000 (less than 100 transactions per year)
 - using Workday or SAP, and
 - with medium-to-high usage of our enterprise solutions
- Or maybe, your target organization is an organization with:
 - less than 3 years in business,
 - located in Winnipeg,
 - with less than 5 employees,
 - ~\$50,000 in revenues per year,
 - with average transaction values between \$2 – \$7 (~10,000+ transactions per year)
 - using QuickBooks, Paypal, and/or Square for accounting and payment services
 - with high usage of our small-to-medium-sized business (SMB) solutions

Please note that it is quite common to market to and support multiple target audiences. For example, an organization might know that ABC are the characteristics of their enterprise and larger customers and XYZ are the characteristics of their smaller / SMB ones. However, understanding these differences allows an organization to better support and direct prospective customers when they express an interest. Because depending on which type of customer they are, there may also be a significantly different **customer journey**. For example, an organization might qualify Acme Company as an “enterprise” company and will treat them in an “enterprise” way. Whereas Jitters Coffee Shop will qualify as a small-to-medium-sized business, so they are treated in a different manner.

Reflection

Think about your primary target audience. Who do you really want to target?

If you have multiple target audiences, try to focus your efforts on your primary target audience and keep your target audiences to less than 4. Otherwise, your marketing tactics and activities may become too broad, diluted, and ineffective in meeting the specific needs of your target audiences.

Step 2: Set Your Organizational Goals & Objectives

After clearly defining your target audience, most marketing strategies require setting up specific goals and objectives. **What does your team / organization want to accomplish?** Do you want to:

- Increase product or service adoption (revenues)
- Identify new customers
- Build brand awareness
- Reduce the number of customers leaving (churn)

You want to ensure that your targeted audiences can help achieve the goals and objectives for your organization. When setting your goals and objectives, consider:

- Any internal timelines,
- Specific benchmarks or KPIs you want to surpass,
- Challenges you have already encountered,
- Parameters such as industry regulations, internal protocols, and data privacy permissions,
- The scope and infrastructure of your internal data and databases, and
- Financial budgets and human resources for ongoing experimentation and updates to your customer personas

A key consideration in developing your goals and objectives is thinking about what you want your prospective customers to do; try to be as specific as possible. For example, you might have primary and secondary conversion goals as follows:

- **Primary conversions**

- Purchase
- Donate

- **Secondary conversions**

The goal of most secondary conversions is to get prospective customers' contact information so marketers can continue to communicate with them and hopefully, convert them later. When prospective customers sign up and provide contact information, not only do organizations get prospect's contact information, organizations also now know which topics interest that prospective customer. This allows the organization to send targeted communications, promotions, and events that relate to these topics and to further engage leads around the topics that they have expressed interest in. For example, if someone signs up for a webinar, a marketer might send a follow-up case study, product or service promotion, or market research related to that webinar at a later date. Here are several common examples of secondary conversions:

- Sign up / provide contact information for:
 - Free or Limited Trial

- Webinar / Demo
- Newsletter
- Downloadable content, e.g., whitepapers, research, etc.
- **Tertiary goal** (*not a conversion!*)
 - Brand awareness and exposure
- **Specific KPIs and Targets**

Also, be sure to set specific and measurable key performance indicators (KPIs) and targets for your marketing activities. For example, how many purchases do you want to get? Or how many people do you want to sign up for your newsletter or to attend your webinar?

Please note that you can (and should) have more than one goal. Remember the purpose of any lead generation strategy is to acquire as many leads as possible, ensuring that those leads support the overarching goals and objectives of the organization. Do make sure your goals support one another and are in alignment with any organizational goals. The main purpose of setting your organizational goals is to test and validate that your target audience can deliver on those organizational goals and objectives. And if you do not set *specific* goals and objectives, how will you know if your actions have been successful or not?

Step 3: Develop Content / Lead Magnets

After you have defined your target audience and set your organizational goals, you can start thinking about creating content to attract your target audience and to achieve your goals and objective. A common marketing strategy to accomplish this is by using lead magnets. A **lead magnet** is a free item or service that is given away for the purpose of gathering contact details. For example, maybe your organization has created a downloadable piece of content like a checklist. To access it, people must fill out a form with their contact information, e.g., their name, email address, job title, organization, etc., which as mentioned earlier, can be used to communicate with and market to them later.

There are many different kinds of lead magnets and most organizations will use some combination of the following types of lead magnets:

- **Educational lead magnets**

Educational lead magnets teach your target audience something they do not already know. This can be in the form of a newsletter, webinar, white paper, or downloadable PDF.
- **Useful lead magnets**

Useful lead magnets provide resources or tools that can help your target audience solve a specific problem or pain point, e.g., a tutorial, checklist, ROI calculator, or other tool.
- **Community-building lead magnets**

Community-building lead magnets create a way for your target audience to be part of a community based on the things they have in common, e.g., direct challenges and group forums.
- **Entertaining lead magnets**

Entertaining lead magnets, primarily used in B2C markets, inspire or entertain your audience,

e.g., quizzes, videos, etc.

- **Bottom-of-funnel lead magnets**

Bottom of funnel lead magnets “push” the prospect from a lead to customer, e.g., free trial, discount codes, free consultation.

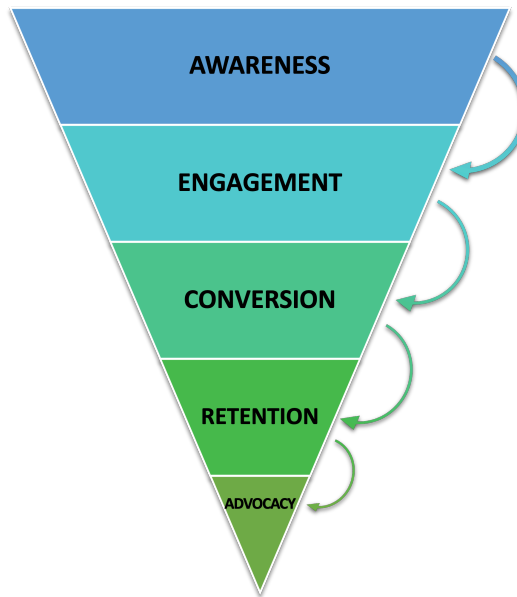

Connecting these to our **conversion funnel**, bottom-of-funnel lead magnets move potential customers (leads) from engagement to conversion.

The primary goal of lead magnets is to identify the specific interests of your target audience. In our **Content Marketing** chapter, we will delve into lead magnet types in more detail.

Step 4: Nurture & Close Your Leads

Once you have identified the specific interests of your target audience, it is now possible to build ongoing, engaging relationships around those interests and ultimately, encourage your target audience to convert. Lead nurturing and closing is generally a key component of an organization’s sales activities and often will be carried out by the sales team.

That said, as customers increasingly consume information, videos, and other “self-serve” content online, this online content coupled with the promotional activities from the marketing team may lead customers to convert on their own, without any person-to-person sales interaction. In these cases, the conversion stages from awareness to conversion may be entirely handled by marketers. This type of sales process is often referred to as inbound sales. The purpose of **inbound sales** is to organically attract, educate, inform, nurture, and guide leads through the purchase decision-making process. In contrast, **outbound sales** focus on approaching prospects and delivering a sales pitch to trigger interest, e.g., cold calls, cold emails, or door-to-door visits.

Regardless of an organization’s inbound or outbound sales strategies, the following recommendations represent several common ways to nurture and close leads:

- **Targeted content**

Tailor intriguing, entertaining, and valuable content to target audience members so you can identify the most qualified leads.

- **Multi-channel lead nurturing**
Reach and nurture your audience where they are — on **multiple** channels! Don't just stick with one channel. Explore a combination of both online and offline marketing channels.
- **Multiple Content Types**
Boost your touchpoints with a mix of content types to increase your interactions and engagement among target audience members.
- **Timely Follow Ups**
Follow up with your leads in a timely manner to keep them engaged and interested as well as to keep your brand top of mind. With the many new marketing automation tools, it is now possible to automate follow ups and ensure that leads get consistent, appropriate, and ongoing messages. Marketing automation will be discussed in more detail in both the **Content Marketing** and **Email Marketing** chapters.
- **Personalized Communications**
Personalize your messaging (and all lead nurturing tactics, when possible) to promote customer conversions.
- **Lead Scoring**
Lead scores are used to determine the likelihood of conversion for a particular prospect based on specific characteristics. These characteristics stem from the customer personas and customer journeys created, which highlights why these activities are valuable. When used properly, a lead scoring strategy can help an organization determine which leads to focus on and which ones may be a waste of time.

Sales and Marketing Alignment

Regardless of your sales strategy, inbound or outbound, it is critical to align your sales and marketing teams to improve your lead nurturing tactics and to boost customer conversions. Ideally, the two teams should work together to accelerate customer conversions and to ensure that the organization is meeting the needs of prospective customers at each and every stage of the customer journey. Because if marketing does a poor job qualifying leads, the sales team has an even harder job converting and closing them.

Step 5: Get Customer Referrals

Often, organizations focus on increasing inbound leads, outbound leads, website visits, or demos. But spending more time getting existing customers to tell others to buy their products or services can lead to better qualified prospects and usually close sales much more quickly. This is because people tend to listen to other customers, clients, or even random people more than they listen to marketing messages from an organization. In fact, here is an article with **over 80 referral marketing statistics showing why customer referrals are so valuable** (<https://review42.com/resources/referral-marketing-statistics/>). Even in the B2B space, customer referrals are important because B2B organizations often have highly connected, small target audiences.

So, how do you get your customers to give you referrals, recommend your products and services, and/or be an advocate, brand evangelist, or an influencer? Here are some suggestions:

- **Exceed Customer Expectations**
Not only do you need to deliver an outstanding product or service, but you also need to provide exceptional post-purchase support.
- **Engage Your Customers**
Stay engaged with your customers so that your brand remains top of mind. This ensures that *when* an opportunity arises, your customers will think to mention your brand.
- **Be Share-worthy**
Give your customers something to talk about and share. And make it easy for them to share the news, update, or promotion. This can be done by providing templates and recommending wording, images, etc.
- **Create a Customer Referral Program**
Reward your customers for spreading the word. But, be sure to align your rewards with their interests, motivators, and drivers. For example, there are many different reward options:
 - **Monetary**, e.g., 5% off for you and/or your referral, free annual renewal for you, or \$100 per referral, etc.
 - **Products**, e.g., offer a free iPad or specific tools that your target audience uses and values
 - **Donations**, e.g., for every referral, \$50 is donated to an environmental charity or other cause-based initiative
 - **Personal Recognition**, e.g., you and your referral will be featured on our website, in our newsletter, and/or on our social media channels.

When creating your customer referral program, think about which rewards (or combination of rewards) your customers will find most beneficial and valuable. Some organizations might be surprised to find that monetary incentives are not as important to their customers as some of the other options listed above. That said, the key to referrals is to ask for them! Here are a few types of referrals to consider:

- Word-of-Mouth Referrals
- Online Reviews
- Social Recommendations & Sharing
- Email Referrals
- Incentive-based Referrals



Once you have gone through the five steps of this lead generation framework, you will want to repeat the steps and go back and ask: are the customers we are connecting with and converting, the same as our target audience? You will also want to compare and evaluate that they are the ones that make the most sense to target. Using this customer data, you may need to tweak and adjust your target audience and customer personas to make sure that they truly represent the customers you are actually serving and that they are the most appropriate customers for your products, services, and solutions.

To successfully create a targeted and sustainable lead generation strategy:

1. Define and identify your target audience(s)
2. Set your lead goals, objectives, and targets
3. Choose the types of lead magnets for your target audience(s)
4. Review your lead nurturing and closing strategies
5. Develop or improve your customer referral program(s)

Key Takeaways

In this chapter, we learned about leads and the lead generation process.

- A lead is any person who has shown some level of interest in an organization's product or service.
- There are a variety of ways to categorize leads:
 - Information Qualified Lead (IQL)

- Marketing Qualified Lead (MQL)
- Sales Qualified Lead (SQL)
- Product Qualified Lead (PQL)
- Service Qualified Lead
- Lead generation is the process of getting leads or attracting and converting target audiences, who have shown an interest in your product or service.
- A lead magnet is a free item or service that is given away for the purpose of gathering contact details.
- The purpose of inbound sales is to organically attract, educate, inform, nurture, and guide leads through the purchase decision-making process. In contrast, outbound sales focus on approaching prospects and delivering a sales pitch to trigger interest, e.g., cold calls, cold emails, or door-to-door visits.
- The 5-Step Lead Generation Framework includes the following steps:
 1. Define Your Target Audience
 2. Set Your Organizational Goals & Objectives
 3. Develop Content / Lead Magnets
 4. Nurture & Close Your Leads
 5. Get Customer Referrals

Lead Generation – Additional Resources

Here are some additional lead generation articles and videos:

- What is a Lead Magnet? – Definition and Guide (<https://sendpulse.com/support/glossary/lead-magnet>)
- How to Conduct a B2B Segmentation (<https://www.hello-adience.com/blog/how-to/how-to-conduct-a-b2b-market-segmentation/>)
- Buyer Persona Creation for B2B Business (<https://www.youtube.com/watch?v=J27f89QxgnA>) [Video]
- 2 Lead Nurturing Software Options for Your Business (<https://www.leadboxer.com/blog/lead-nurturing/>)
- 80 Referral Program Examples (<https://www.referralcandy.com/blog/47-referral-programs/>)

Media Attributions

- Lead generation by Sunit Nandi is licensed under a CC BY-NC-SA 4.0 licence.
- 5-step lead generation framework by Rochelle Grayson is licensed under a CC BY 4.0 licence.
- Conversion funnel by Rochelle Grayson is licensed under a CC BY 4.0 licence.

9.

Content Marketing

Learning Objectives

By the end of this chapter, you should be able to:

- **Develop** a content marketing strategy
- **Map** appropriate content types across your conversion funnel
- **Explain** the purpose of content calendars
- **Describe** several content marketing do's and don'ts

Content Marketing and the Customer Journey

To start the discussion of content marketing, let's first review some key concepts and how they tie into a content marketing strategy. As mentioned in the **Customer Journey Mapping** chapter, we have broken down the customer journey into the following five stages:

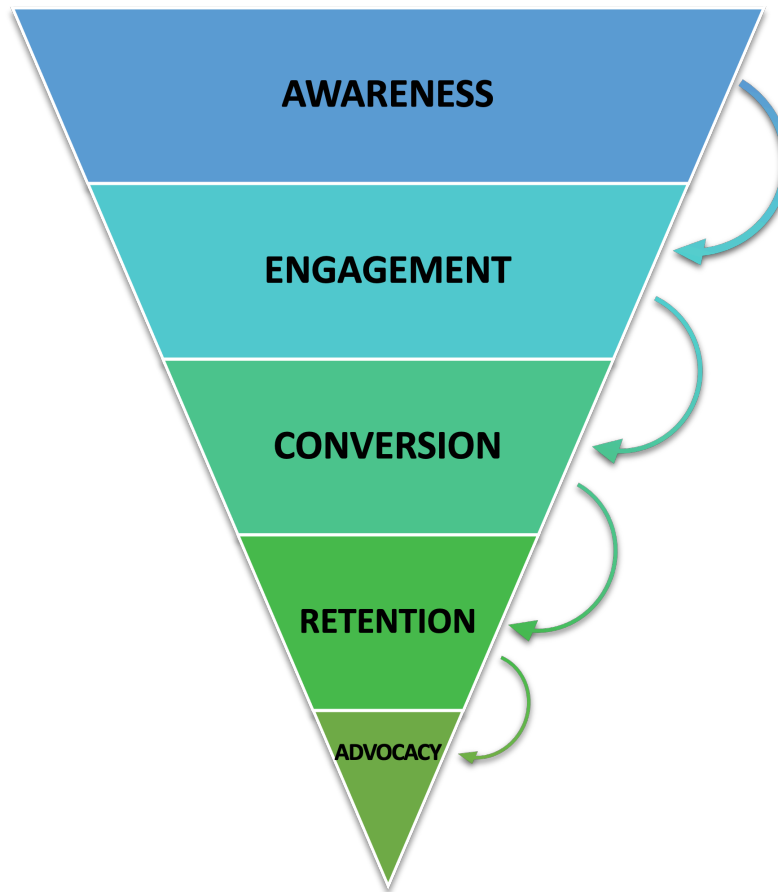

- **Awareness**
A prospective customer learns about an organization, product, or service.
- **Engagement**
A relationship develops between the prospective customer and the organization via several, positive interactions.
- **Conversion**
The prospective customer decides to buy a product or service from the organization.
- **Retention**
The customer has a strong and loyal relationship with the organization and becomes a regular customer or active user.
- **Advocacy**
A regular customer is satisfied with the organization's products and/or services and recommends them to others.

Since organizations want to market to and support prospective customers at every stage of this journey, it is essential to plan specific content for each stage along this journey. The following image highlights different content categories as customers move through the customer journey. ()

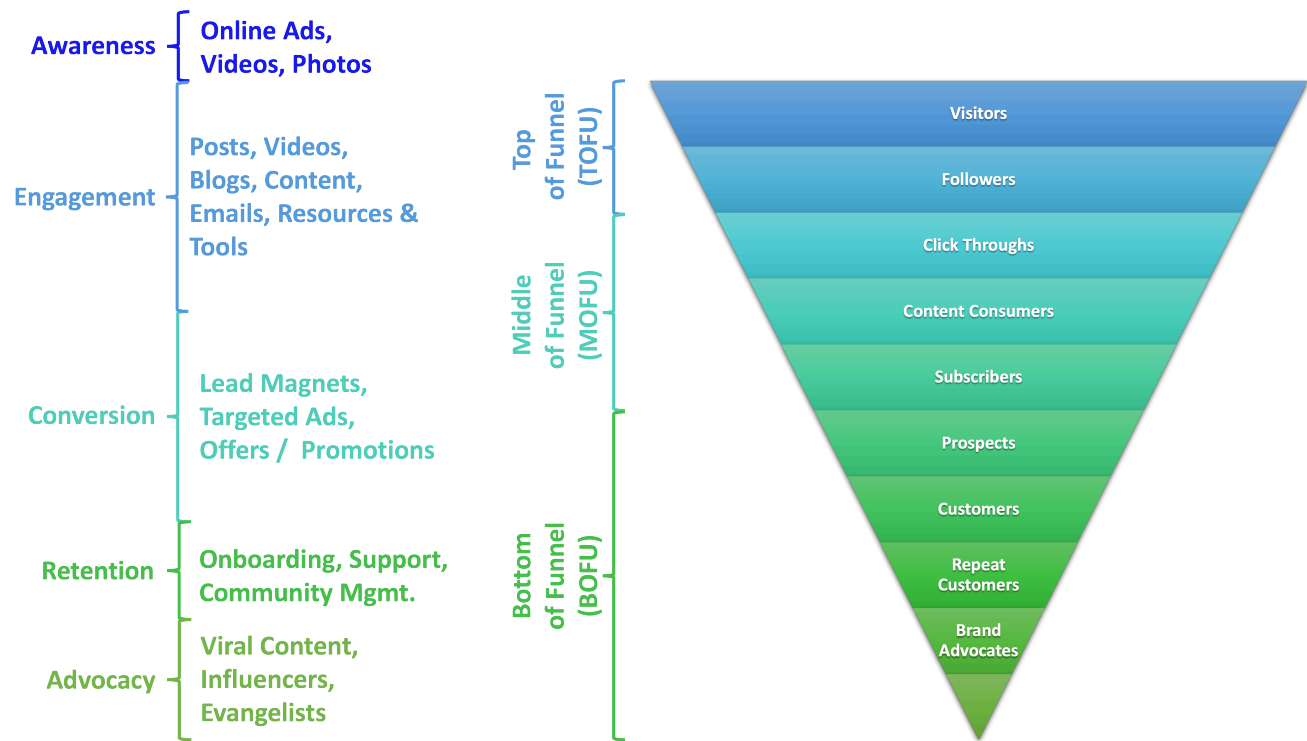

Content Categories in the Customer Journey [Image Description] (#cccjid)

On the left-hand side, we see the five customer journey stages – awareness, engagement, conversion, retention, and advocacy. And next to each of these stages, there are a few content categories that might be helpful to prospects and/or customers. For each stage, organizations should ask:

- What information is our target audience seeking?
- How can we best support / help them?
- Which pain points and questions can we address proactively?
- And how can we move them more quickly to the next stage?

Simply stated, as your target customers move through each of these stages, marketers need to identify the specific content that is most important at that stage. Please note that the content details and requirements will be significantly influenced by the type of organization, the customer persona, and the specific customer journey. But let's look at some common types of content across a customer journey.

Top of Funnel (Awareness, Initial Engagement)

At the top of the funnel, organizations are usually trying to drive awareness. As a result, many of the goals associated with this stage include:

- increase traffic
- increase our social media fans and followers
- increase media coverage

To achieve these goals, organizations need to create and map content that matches the needs of customer personas in the awareness stage of a customer journey. Typically, this would include content that brings awareness of your organization, products, services, and solutions. Often this stage includes content like videos, paid ads, social media posts, etc.

Middle of Funnel (Ongoing Engagement, Secondary Conversions)

At the middle of the funnel, prospective customers are interested and considering their options. They are aware you exist but are seeking more information about your solutions and/or trying to better understand who you are and what you offer. These leads may have come from an advertisement, link in a post, forwarded email, etc. In this stage, marketers want to make sure to offer content like blog posts, articles, case studies, webinars, videos, etc. that highlight why your organization is the most qualified and why you offer the best solutions to meet the target customer's needs.

Bottom of Funnel (Primary Conversion, Retention, Advocacy)

At the bottom of the funnel, you will have qualified marketing, sales, product, or services leads. These leads have expressed interest, have been engaging with your organization or content, but have not yet committed to your primary conversion – usually a paid purchase. At this stage, marketers want to create content that will create an incentive for leads to convert. This content might include targeted ads, specific email offers and messages, and other lead magnets that provide an opportunity to convert.

Also included in this stage are new and repeat customers because remember the bottom of the funnel does not end at the point of purchase but continues post-purchase to ensure satisfied customers and to develop brand advocates. Remember the importance of customer referrals from the last chapter. So, your content marketing strategy needs to continue to support your leads long after they convert. Every organization should encourage their customers to become brand influencers and advocates – in essence, to start marketing on the organization's behalf and to become an unofficial sale force. The easiest way to seed these kinds of conversations is to provide content that customers can easily share with their own networks. However, do make sure that your customers are satisfied with their customer experience, and feel connected to the brand and the brand's community. This is because viral content can go both ways and complaints tend to spread much faster than praises.

Content Strategy

To develop your content strategy, there are several questions you need to address. In answering these questions, you can ensure your content plan and activities meet the needs of your target audience and are sustainable by your marketing team and the organizational resources you have available. The following key questions answer the what, why, how, where, when, and who for any content strategy:

What

- **What are our content objectives?**

Your content objectives should tie in and support your overarching marketing and

organizational objectives.

- **What do our community and customers want to hear from us?**

A content strategy is about promoting messages that your community and customers want to read, see, or hear. It is no longer about pushing brand messages unless those messages align with what your target audience finds interesting and wants to engage with. Remember it is not just about your organization; it is about your target audience in relation to your organization.

- **What topics are we going to cover?**

Spend some time listening to your target audience e.g., on social media, to see and hear which topics they find most engaging or are most passionate about. Your topics should be driven by your target audience and their preferences. That said, conduct a brainstorming session with your own team because they may have ideas, as well. Then, compare your list to what you discover with your target audience.

- **What formats are we going to use, e.g., blogs, podcasts, videos, infographics, etc.?**

Similarly, find out which content formats perform the best or get the most reactions (likes, shares, comments, etc.) from your target audience. Once again, this is not about your organization's preferences, but rather the content preferences of the community.

Why

- **Why does anyone care about our content?**

Marketers need to be clear about why their target audience cares about the content being produced. Creating content for content's sake makes no sense. Since there is so much content being produced and shared, marketers need to produce content that gets above the noise. In essence, what is the benefit to your target audience?

- **Why are we creating this content?**

Once you know why your target audience wants this content, ask if this content makes sense for your organization? The answer to this question should align with your goals and objectives and what you want your target audience to do.

How

- **How are we adding value to our customers / community?**

Again, being clear on the benefits your content will provide to your target audience is key. When there is value in the content, people will pay attention, share, and discuss that content. Your organization is also then seen as a valuable contributor to the community. So, when you post or share content of value, the community will take notice.

- **How are we going to deliver our message?**

This question is a follow up to the content formats. For every piece of content, there is the content production side and the content delivery side. Make sure you know how to deliver your content to those places where your target audience is located.

- **How should we say it (tone, language, imagery, etc.)?**

Another benefit of listening to your target audience is learning about their language, tone, and

imagery preferences. To be a part of their conversation, use similar vocabulary, tone, e.g., casual or formal, and imagery most commonly used.

Where

- **Where will we get the content** (assess your limitations)?
Many organizations create ambitious content plans. However, plan realistically keeping your content production capabilities in mind. For example, if you plan to distribute lots of videos, do you have people within your organization, who have the video production and editing skills to support this? If not, do you have a sizable video production budget to hire outside resources to complete some of these tasks? If that does not seem likely, you may want to reduce your video content plans and replace it with content that your organization can more easily produce. There are always trade-offs, but it is recommended to play to your organizational strengths.
- **Where will we curate content?**
One complaint that frequently comes up is the amount of time required to create original content. However, the majority of the content you share should not be original content, but rather content created by others. Marketers should be finding relevant content that is of interest to their target audience. Where does that content live? What other websites, communities, or news sites can we introduce to our community that they would find interesting?
- **Where will our content be published?**
While there may be many places to distribute your content, focus on the top 1-2 channels and do them well. Once you have built up a loyal following, consider expanding to other channels or platforms. Unless your organization has a very large team and large budget, managing a meaningful presence across several marketing channels can become quite challenging to maintain and sustain. And usually, the quality of the content and target audience interactions suffer when managing too many channels.

When

- **When will our content be published?**
Tactically, it is important to know when to publish content to get the most interactions and engagement. Again, listening to your target audience, reviewing your customer personas, as well as understanding the cadence of your target audience's daily, weekly, monthly, and seasonal rhythms can be quite beneficial in knowing when to publish content. For example, if your target audience is mothers with young children, you may want to think about posting content in the evenings after the children have been put to bed. But, if you are targeting working professionals, you might want to post in the morning prior to the workday's start or during lunch time when these workers might take a lunch break.
- **When will our content need to be updated?**
Another area marketers often forget to think about is updating of content. In today's ever-changing markets, content can quickly become old and stale. However, updating content can provide an opportunity to present the information again in a new context or to a new

audience. Think about developing a content review process and updating content with fresh eyes. Your content is an asset, and you should try to leverage it as much as possible.

Who

- **Who will be responsible for producing the content?**

As mentioned, producing content takes time. Make sure you have clearly outlined who is responsible for which part of the content production. More importantly, keep in mind that with multiple people involved, there may be dependencies. For example, if the graphics designers will be creating all the graphics for an article, by when do you need those graphics so that you can finish the article for the paid advertisement deadline?

- **Who will maintain the content over time?**

When planning for content to be updated, who will be responsible for making sure the content is properly maintained, e.g., making sure links are still working, etc.

- **Who will monitor, interact, and support with the content?**

Often marketers spend lots of time planning the launch and distribution of content, but who will interact with the community when people leave comments or ask questions? The goal of content marketing is to engage and interact with your target community. Make sure there is someone responsible for engaging with the community, being responsive, and managing the open dialog that content marketing sparks.

Content Calendars

Editorial Calendar (sample)						
Topic	Author	Channel	Pub date	Images/Media	Notes	Other social channels
Current programming						
Antiques auction	Sam	Blog home page	6/12/13	Assigned to Jeff	Let's blow this out!	
Clean Out Your Closet Challenge	Susan	Main website	6/26/13	Stock photo		Support w/ Twitter campaign
Flavors of a Neighborhood	Jenny?	Blog	7/12/13	Already shot	Series. Start w/ Mission Heights	
What do we call our logo?	Jeremy	Blog	7/19/13	Logo	Crowd-sourcing contest	
Future programming						
One Stop and digital literacy	Alice	Blog	Sept.?	TBD	In progress.	

Editorial Calendar (sample)

Now, that you have a solid content strategy, you will need to create a content plan that highlights when content will be distributed, on which platforms, covering which topics, for which target audience(s), showing who's responsible, and all the content production details. Typically, all of this information will live within a content calendar. **Content calendars** map out all the details related to the content that marketers plan to create. They are useful tactical tools because they can:

- Provide a comprehensive content overview
- List what needs to be done

- Highlight missing opportunities, e.g., if the content is all focused on the same target audience or the same format

The above image provides a simple example of a content calendar. As you can see, Excel or Google Sheets work well for this type of plan. However, there are many content calendar templates and here are two from Hubspot and Hootsuite:

- The Social Media Content Calendar Template Every Marketer Needs (<https://blog.hubspot.com/blog/tabid/6307/bid/33415/the-social-media-publishing-schedule-every-marketer-needs-template.aspx>)(Free Hubspot Template)
- How to Create a Social Media Content Calendar: Tips and Templates (<https://blog.hootsuite.com/how-to-create-a-social-media-content-calendar/>) (Hootsuite)

You can also conduct a search on Google for content calendar and templates. While most templates cover the basic attributes for managing your content, there are a few areas you may want to make sure are included in your content calendar:

- **Target Audience**
Since you may be targeting different audiences, this is a nice way to see at-a-glance that you have a good mix of content targeting a variety of stakeholders / audiences.
- **Content / Media Type**
Be sure to add the type of media for your post: infographic, video, story, text post, audio, etc. This ensures you have a nice mix and that all posts are not the same type of content / media.
- **Dependencies**
In some cases, your post(s) may be dependent on someone else completing part of it or completing something else related to it. It's good to write down these dependencies so that you know who needs to get what to you and by when.
- **Content Themes / Topics**
Many marketers may have common themes or topics that repeat on a regular basis, e.g., Trivia Tuesdays, Throwback Thursdays, Funny Fridays, etc. Categorizing your content this way, makes it easier to find and curate content that fits into the appropriate "bucket". From a follower's perspective, it also creates a pattern to your posts so that followers know what to expect and when.
- **Comments / Notes**
There may be some additional comments or notes you want to include. Give yourself a space to include these.

For marketers managing multiple marketing channels, you can either put all your content into one calendar or have multiple content calendars, e.g., a social media content calendar, email content calendar, blog post content calendar, conference calendar, etc. The choice is up to you to decide which system will work best for your team and organization.

Promotional vs. Original vs. Curated Content

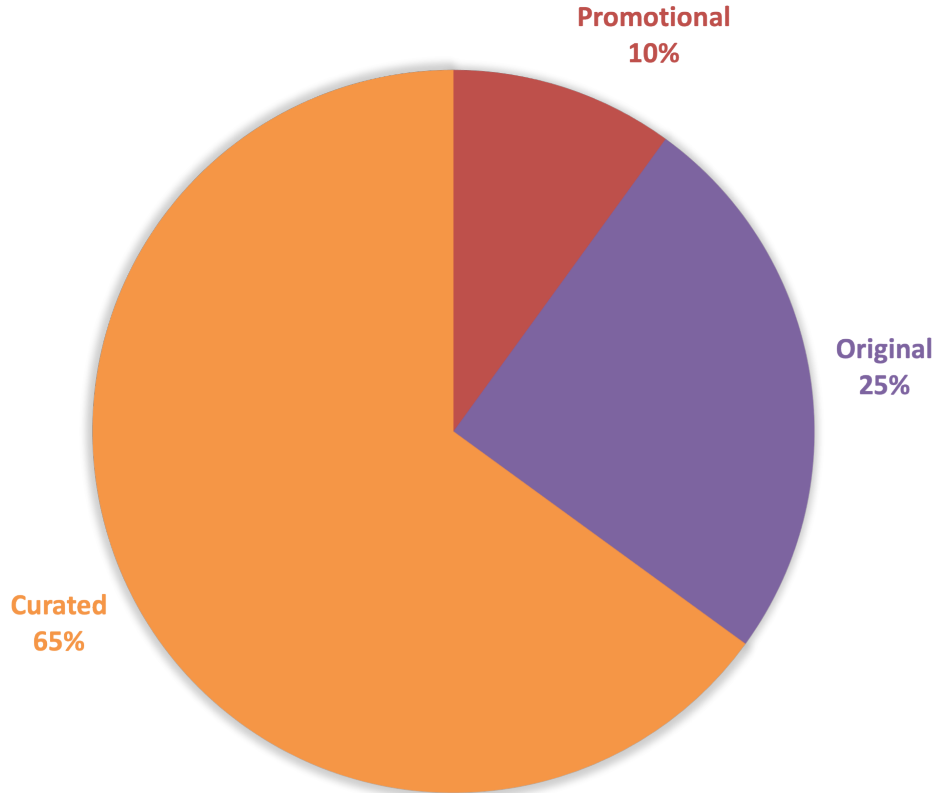

One frequently asked question is how do I find time to create and manage all this content? This is perhaps the biggest misunderstanding about content marketing; the perception that all content must be original content. As mentioned before, the majority of content shared, should actually be from other sources. The above pie chart provides a guideline on content splits:

- **Promotional (10%)**
Promotional content refers to content that is trying to sell and/or heavily promote an offer and should be ~10% of all the posts distributed. This is because most people do not like being sold to all the time. Remember content marketing is about building relationships with your community and to do this, marketers cannot be selling all the time. If there is too much selling content, your target audience will simply stop listening.
- **Original (25%)**
Original content is content that your organization creates. As mentioned in the content strategy, you want to create original content that provides value and benefits to your target audience and that aligns with your organizational goals and objectives. However, original content takes time and money. It is also tempting to have original content focus on the organization. So, to limit your content marketing feeling too much like self-promotion, you will want to limit the number of posts that highlight your organization. Generally speaking, you want ~25% of your posts to be original.
- **Curated (65%)**
The bulk of your content should be curated content. Curated content is content created and

distributed by others that is of interest to your target audience. This could be articles, market research, complementary products or services to your offerings, or any other content that your target audience might find of interest. By sharing content from others, you show your target audience that you are willing to share content produced by others and that you are also happy to share any content of value regardless of who produced it and give someone else credit for it. An important benefit of this strategy is that when you do post your own original content, the other content producers, whose content you have promoted, are more likely to reciprocate and share your content with their networks. Most importantly, this signals to your target audience that you are simply looking for the best content for them, regardless of the source.

Content Marketing Do's and Don'ts

So far, we've talked about developing a content marketing strategy and plan. But what are tips and tricks to successfully launching a content marketing strategy? Here are few do's and don'ts that build on many of the concepts and questions already discussed:

- Do's
 - **Add Value**
Review your customer personas and customer journeys to make sure you are addressing the pain points, goals, and questions that your prospective and exiting customers have.
 - **Tell Stories**
Apply the concepts and frameworks from the **Fundamentals of Storytelling** and **Visual Storytelling** chapters.
 - **Encourage Conversations / Discussion**
Remember content marketing is merely a vehicle to learn more about your target audience, to engage with them, to find out what they are most interested in and passionate about, and to build longer term relationships.
 - **Experiment**
Try a variety of different content formats, topics, etc. Marketers willing to experiment can sometimes stumble across some great discussions that lead to valuable customer insights and even viral sharing.
- Don'ts
 - **Hard Sell**
Again, no one likes communications to only be about selling. Mix up your messages to also include curated content and content that simply benefits the community.
 - **Be Generic**
The details are the interesting parts. Your goal is not to be like everyone else; be unique and highlight how what you are offering and who you are is different from others in your industry.

- **Ignore Your Community / Leads**

Make sure to follow up and respond to messages from your community. Pay attention to your target audience and they will pay attention to you.

Developing Content / Lead Magnets

In the last chapter, we introduced the concept of lead magnets. Remember a **lead magnet** is a free item or service that is given away for the purpose of gathering contact details. Now that we have walked through how to build a content strategy and plan, you may want to think about incorporating lead magnets into your content plans. So, the following lists provide several examples of lead magnets in the various categories:

- **Educational Lead Magnets**

Educational lead magnets teach your target audience something they do not already know:

- **Training / Tutorials** (*How-to*)

Create a variety of how-to training / tutorial content. Please note that this content can be produced as:

- Video
- Audio
- Written or Video Transcript

- **Short course**

Offer a short course or a portion of a longer course for free.

- **Sample Chapter / Video Clip / Audio Clip**

Create a trailer or teaser of a longer piece of content.

- **Downloadable eBook / PDF / Report / Guide / Audiobook**

Create a download piece of content

- **Mind Map / Concept Map / Framework**

This content works particularly well in design by providing others with visual concepts.

- **Infographics**

Visualize some text-heavy content in an infographic. Free services like Canva (<https://www.canva.com/>), Piktochart (<https://piktochart.com/>), and Visme (<https://www.visme.co/>) offer many infographic templates.

- **Webinar sign-up / Event Tickets**

Offer an educational webinar or in-person event.

- **Predictions / Forecasts**

Publish some predictions or forecasts about your industry or other area of interest.

- **Presentations**

Provide an educational presentation.

- **Newsletters**

Create an educational newsletter or newsletter series.

- **Virtual Library / Vault**
Build an online library or source where leads can access a variety of content on a specific topic.
- **Market Research / Roundup / State of the Industry**
Conduct some market research and provide a summary of your findings.
- **Recordings / Replays with additional commentary**
Record some content or replay some existing content with additional commentary provided by you or your team.
- **Coles / Cliff Notes / Content Summaries**
- **Useful Lead Magnets**
Useful lead magnets provide solutions with which your target audience can solve a problem:
 - Cheat Sheets / List of Shortcuts
 - Checklists
 - Calculators, e.g., ROI calculators, Calorie Calculator, etc.
 - Case Studies / Examples
 - File & Design Templates (a.k.a. Swipe Files), e.g., Content Calendar Templates (digital or printable)
 - Toolkits, e.g., design themes, digital assets, icons, etc.
 - Scripts, e.g., Code Scripts, etc.
 - List of Resources / Inspirations
 - Calendars / Plans or Planner Pages
 - Idea Generators
 - Recipes
- **Community-building Lead Magnets**
These lead magnets create a way for target audiences to build a community based on the things they have in common:
 - Direct challenges, e.g., Bottle Cap Challenge
 - Members-only website or portal
 - Vertical, “niche” group forums
 - Mastodon (<https://joinmastodon.org/>) (open, Twitter-like)
 - PixelFed (<https://pixelfed.org/>) (open, Instagram-like)
 - Okuna (<https://www.okuna.io/a/login>) (open social network)
 - Mahara (<https://mahara.org/>) (open eportfolios)
 - Slack forums
 - Social Media Groups, e.g., Facebook / LinkedIn Groups
- **Entertaining Lead Magnets**

The following lead magnets may inspire or entertain your audience:

- Quizzes
 - Surveys
 - Contests / Giveaways
 - Comic Strips
 - List of Quotes / Image with a Quote (a.k.a. Quotography)
 - Desktop Wallpaper
 - Zoom Virtual Background
 - Web / Mobile App or Game / Interactive
 - Manifesto
- **Bottom-of-funnel Lead Magnets**

These lead magnets (offers) move the target customer from lead to customer:

- Free Shipping
- Free Trial (service, course, or product)
- Coupon / Discount Codes
- Free Service Session / Consultation / Coaching Session
- Free Quote
- Instant access to a free add-on or premium service / feature
- Buy-one-get-one (BOGO) Offer
- Catalog
- Case Studies
- Moving Up a Waiting List

Summary

To successfully build your content strategy and plan, be sure to answer the following questions:

Content Strategy Questions

WHAT	<ul style="list-style-type: none"> • What are our content objectives? • What does our community/customers want to hear from us? • What topics are we going to cover? • What formats are we going to use, e.g., blogs, podcasts, videos, infographics, etc.?
WHY	<ul style="list-style-type: none"> • Why does anyone care about our content? • Why are we creating this content?
HOW	<ul style="list-style-type: none"> • How are we adding value to our customers/community? • How are we going to deliver our message? • How should we say it (tone, language, imagery, etc.)?
WHERE	<ul style="list-style-type: none"> • Where will we get the content (assess your limitations)? • Where will we curate content? • Where will our content need to be updated?
WHEN	<ul style="list-style-type: none"> • When will our content be published? • When will our content need to be updated?
WHO	<ul style="list-style-type: none"> • Who will be responsible for producing the content? • Who will maintain the content over time? • Who will monitor and interact with the content?

And using some of the lead magnet ideas from this chapter, map your content against the appropriate stages of your customer journey:

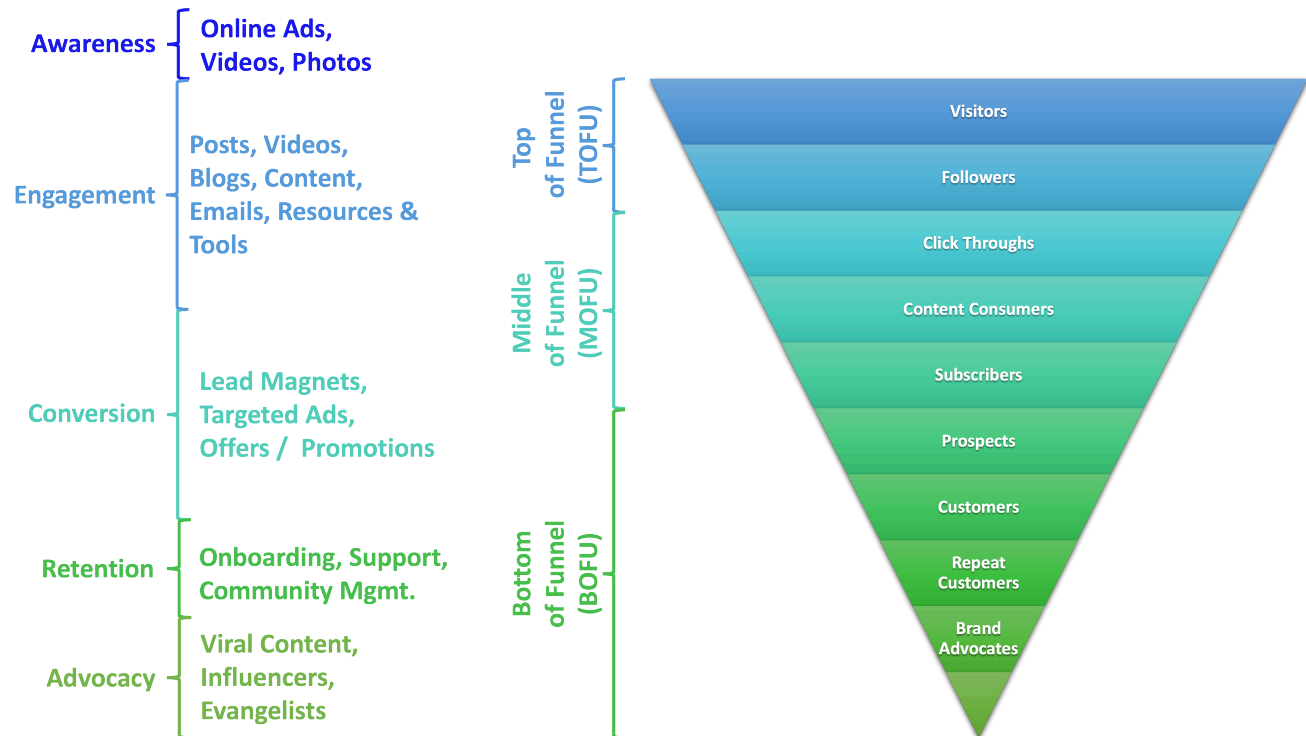

Key Takeaways

Content marketing can be a powerful strategic and tactical approach to connecting to and learning about target audiences.

- As target customers move through each of the five customer journey stages – awareness, engagement, conversion, retention, and advocacy – marketers need to identify the specific content that is most important at each stage.
- To develop your content strategy, marketers need to answer key what, why, how, where, when, and who questions to ensure their content plan and activities meet the needs of the target audience and are sustainable by the marketing team and the organizational resources available.
- Content marketing is not just about creating content, its goal is to build meaningful relationships with prospective and existing target audiences.
- The ideal content mix contains ~10% promotion content, 25% original content, and 65% curated content.

Content Marketing – Additional Resources

Here are some additional content marketing articles:

- 69 Highly Effective Lead Magnet Ideas (<https://optinmonster.com/9-lead-magnets-to-increase-subscribers/>)
- Where to find 100+ Free Lead Magnet Templates (<https://copygoals.com/lead-magnet-templates/>)
- 97 Amazing Freebie (Content Creation) Sites For Founders & Makers (<https://logobly.com/blog/freebie-sites-for-founders-makers/>)
- 13 Stock Video, Stock Image, and Stock Audio Resources for Creators and Marketers (<https://www.socialmediaexaminer.com/stock-video-stock-image-stock-audio-resources-creators-marketers/>)

- The Top 149 Social Network Open-Source Projects (<https://awesomeopensource.com/projects/social-network>)
- 10 Best Podcast Hosting Platforms (<https://www.thepodcasthost.com/websites-hosting/best-podcast-hosting/>)

And, here are several free industry certifications related to content marketing:

- SEMrush Content Marketing Toolkit Course (<https://www.semrush.com/academy/courses/content-marketing-toolkit-course>) (3 hrs. – SEMrush)
- Content Marketing Fundamentals Course with Ashley Segura (<https://www.semrush.com/academy/courses/content-marketing-fundamentals-course-with-ashley-segura>) (2 hrs. – SEMrush)
- Hubspot Content Marketing Certification (<https://academy.hubspot.com/courses/content-marketing>) (6 hrs. – Hubspot)
- YouTube Creator Academy – Create Great Content (<https://creatoracademy.youtube.com/page/course/great-content?hl=en>) (1 hr.)

Image Descriptions

()Content Categories in the Customer Journey Image Description:

A diagram showing what types of content are used to reach customers at different stages of the customer journey. Image description available.

Part of Funnel	Stage	Customer Type	Types of Content
Top	Awareness	Visitors	Online ads, videos, photos
Top	Engagement	Followers	Posts, videos, blogs, content, emails, resources, tools
Middle	Conversion	Click throughs, content consumers, subscribers	Lead magnets, targeted ads, offers/promotions
Bottom	Retention	Prospects, customers, repeat customers	Onboarding, support, community management
Bottom	Advocacy	Brand advocates	Viral content, influencers, evangelists

Return to the Content Categories in the Customer Journey image (#retccj)

Media Attributions

- Conversion funnel by Rochelle Grayson is licensed under a CC BY 4.0 licence.
- Content marketing conversion funnel by Rochelle Grayson is licensed under a CC BY 4.0 licence.
- Editorial Calendar (sample) by JD Lasica is licensed under a CC BY 4.0 licence.
- Ideal content mix – promotional – original – Curated by Rochelle Grayson is licensed under a CC BY 4.0 licence.

10.

Search Engine Optimization (SEO)

Learning Objectives

By the end of this chapter, you should be able to:

- **Explain** what search engine optimization (SEO) is
- **Describe** the differences between on-site and off-site SEO



What is Search Engine Optimization (SEO)?

Search engine optimization is the process of getting your webpages and content to rank higher in non-paid (also known as “organic”) search engine results so that you increase the quality and quantity of traffic to your website or content.

Please note that the goal of SEO is not simply to optimize for the search engines, but rather to structure your content so that target audiences can easily find content that provides the answers they seek. Understanding what people are searching for online, the kinds of words or terminology they are using, and the types of content they want to consume are critical in any search engine optimization strategy.

When done correctly, SEO allows marketers to better reach and connect with people searching for the products and services their organization offers.

From your customer personas, you should know what your target audience wants and is interested in. SEO simply helps marketers structure their content so that search engines can find, understand, and index it and ultimately, deliver it when a target customer is looking for it.

Why is SEO Important?

In digital marketing, there is a lot of discussion about using paid advertising, social media, and other online platforms to generate traffic and interest. However, the majority of online traffic is driven by search engines. For example, of all Canadian searches, only ~2.8% of people click on paid advertisements. SEO delivers ~20X more traffic opportunities than paid advertising on both mobile and desktop.

Search engines also produce some of the highest qualified leads because when someone is searching, marketers know exactly what that person is looking for. Capturing a lead with a very specific search intention allows marketers to deliver a specific solution based on what that person needs at that very moment. Generally, these search intentions are categorized as follows:

- **Informational**
This is when someone is searching for information.
For example: “What is the best type of laptop for photography?”
- **Navigational**
This is when someone is searching for a specific website.
For example: “Best Buy”
- **Transactional**
This is when someone is searching to buy something.
For example: “good deals on MacBook Pros”

Understanding the above objectives allows marketers to create content that specifically addresses these distinct intentions.

Over time and if set up properly, SEO can also organically grow and increase your traffic without additional investments, especially if your content is the best match for specific search terms. In essence, by spending time to properly structure your content for search engines, your organization could see increased traffic, engagements, and customers over time.

On-Site SEO & Keywords

Within search engine optimization, there are two primary strategies that most marketers will want to explore: on-site and off-site SEO. **On-site SEO** focuses on optimizing the content and structure of a website so that it ranks well (*typically within the first 10 search results, or on the first page of search engine results*) for specific search phrases (also known as “keywords”) that are relevant to an organization’s website or content.

A key element of on-site SEO is ensuring that the keywords or key phrases your target audience searches for are contained in the content and structure of your webpages. Let's walk through an example. **Fable Ice Cream**, a Saskatoon-based ice cream shop, has heard about SEO and wants to improve how often they show up in organic search results. To do so, they might ask questions such as:¹

- What types of ice cream, desserts, snacks, etc. are people searching for?
- Who is searching for these terms?
- When are people searching for ice cream, snacks, desserts, etc.?
 - Are there seasonality trends throughout the year?
- How are people searching for ice cream?
 - What words do they use?
 - What questions do they ask?
 - Are more searches performed on mobile devices?
- Why are people seeking ice cream?
 - Are individuals looking for health-conscious ice cream or just looking to satisfy a sweet tooth?
- Where are potential customers located — locally, nationally, or internationally?

Asking these questions is a crucial planning step that will guide Fable Ice Cream's keyword research and help them craft better content. Understanding how a target audience searches for a product, service, or information is a crucial first step and in answering the above questions, marketers can come up with several keyword and key phrase ideas.

Often marketers will now start thinking about creating content using these terms. However, there are other structural and hidden areas of your webpages that should be considered, as well.



An interactive H5P element has been excluded from this version of the text. You can view it online here:
<https://opentextbc.ca/foundationdigitalmarketing/?p=80#h5p-3> (<https://opentextbc.ca/foundationdigitalmarketing/?p=80#h5p-3>)

1. Fable Ice Cream (<https://www.fableicecream.com/>)

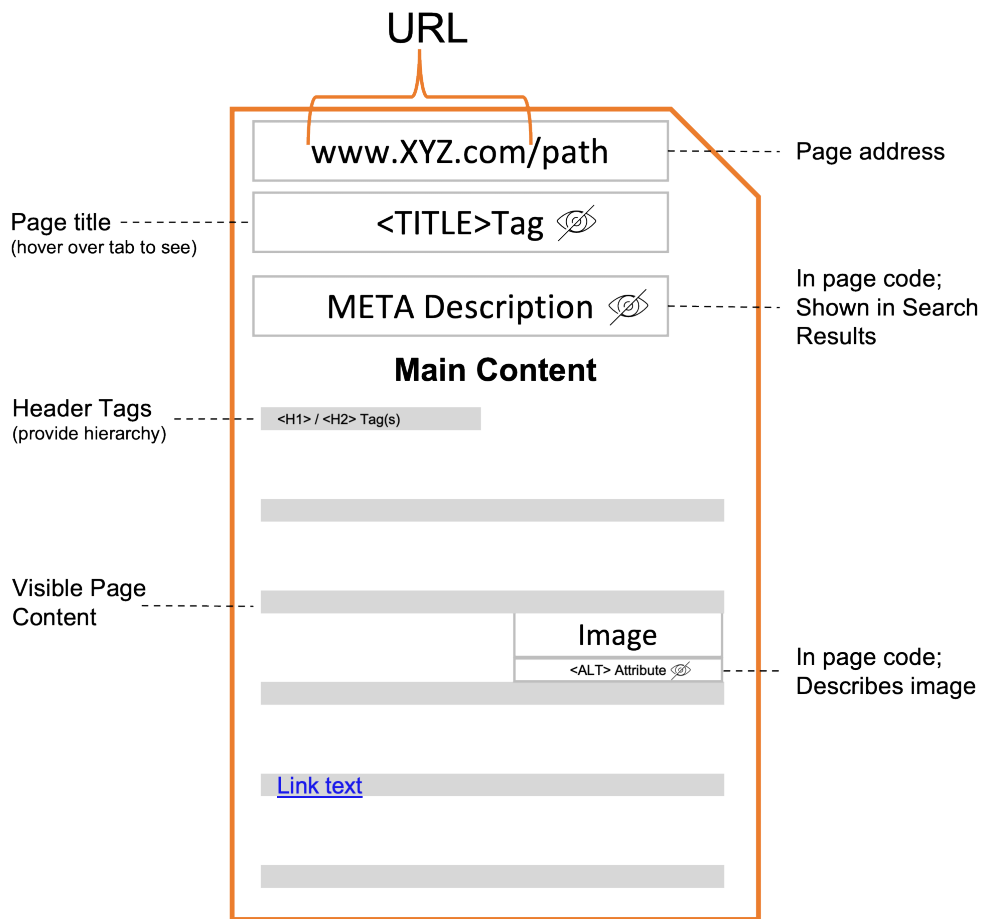

In the above image, you can see the anatomy of a webpage and when you are incorporating your keywords, be sure to include them in the following:

- **URLs and Paths**

While not as creative and brandable, domain names that are descriptive, e.g., wine.com, work well for SEO. And if you have multiple webpages on your website, consider including keywords in your paths, i.e., the text after the slashes (/). For example, wine.com/red-wines.

- **Title Tag**

The title tag is one of the most important page factors because it tells the search engines what the entire page is about. While this tag is hidden when viewing a webpage, it is the web page title (in blue) that search engines show in their results (see image below – “Search Engine Land | Must Read News ...”). To see the title tag for a webpage, simply hover your mouse over the top of any web browser tab.

- **Meta Descriptions / Snippets**

A meta description is the short summary that appears underneath your website title on the search engine results page and includes information about your webpage (see red box below). Again, this information is not visible when viewing the actual webpage, but rather is information created for search engines to display in their results. Many website builders like WordPress, Wix, Weebly, etc. will have settings where you can enter this description and the title tag for each webpage. However, in some cases, you may need to ask your website developers how this information can be entered.

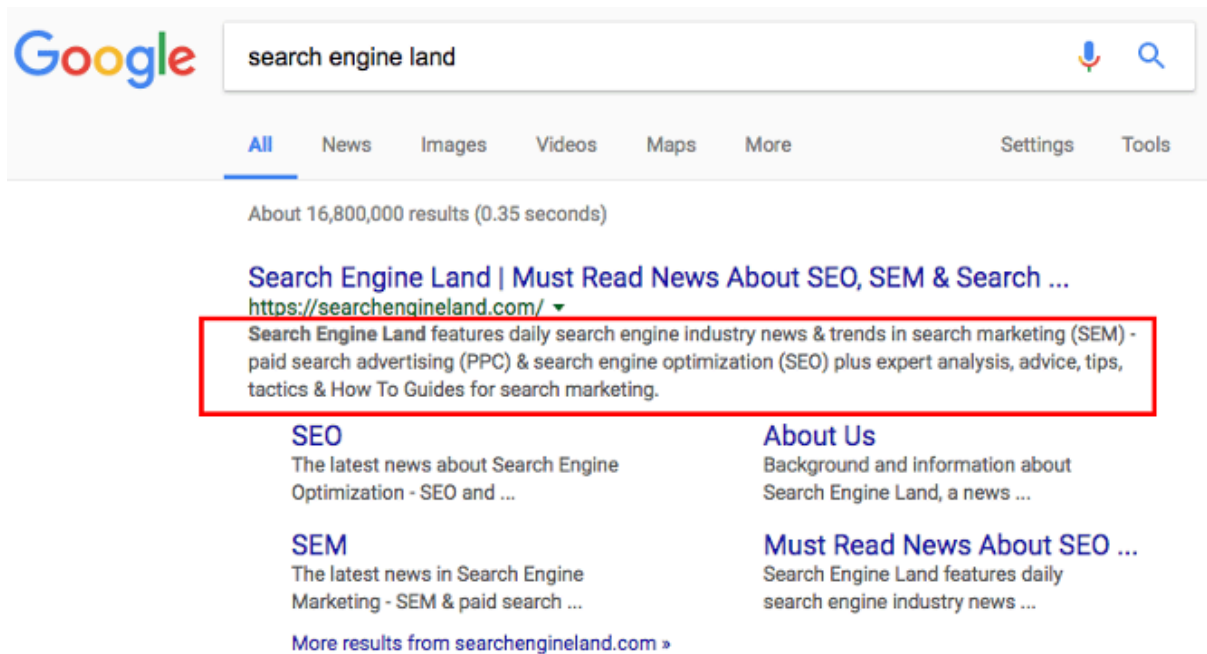

- **Main Content / Body Copy**
The main content, also called Body Copy, is the visible content you see when you visit a webpage.
- **Header Tags**
Header tags, also known as heading tags, are used to separate headings and subheadings on a webpage. They rank in order of importance, from H1 to H6, with H1s being the most important. Header tags improve the readability and SEO of a webpage by creating a hierarchy similar to a table of contents or outline. For example, in this chapter, “What is SEO”, “Why is SEO Important”, and “On-site SEO & Keywords” are H2s, which means that all these headings have the same importance.
- **Image Alt Text**
Search engines cannot “see” images. As a result, images should always have Alt text to describe what is in the image. Search engines will then use this Alt text to match searches. Even though Alt text is not visible, it is an important addition for SEO and for any visitors using screen readers to view a webpage.
- **File Names (including images)**
When saving and uploading files, try to incorporate the appropriate keywords into the file name. For example, an image file with the name CN_Tower.jpeg is much better than IMG4095.jpeg.
- **Link Text**
When creating links to internal and external webpages, make sure the text used for the link is descriptive. For example, instead of writing “click here (https://developers.google.com/style/link-text) to read an article”, write “read this article from Google on Link Text (https://developers.google.com/style/link-text)”.

Now, that you have considered incorporating keywords into the structural areas of your webpages, you can create visible content that answers the questions your target audiences ask.

If you want to further research and identify related or similar keywords, there are many online tools that can help. First, create a list of potential keywords, phrases, and questions and then, enter those terms into any of the following online services:

- Google Search Console (<https://search.google.com/search-console/about>) – shows a lot of data about the keywords that you **already** rank for.
- Google Keyword Planner (<https://ahrefs.com/blog/google-keyword-planner/>) – finds other keywords, but only list ranges for search volumes.
- Google Trends (<https://trends.google.com/trends/>) – visualizes the relative search popularity of a keyword over time.
- Keyword Generator (<https://ahrefs.com/keyword-generator>) – finds up to 150 keyword ideas for any seed keyword.
- Keyword Sheeter (<https://keywordsheet.com/>) – pulls thousands of autocomplete suggestions from Google.
- Answer the Public (<https://answerthepublic.com/>) – finds questions, prepositions, comparisons, alphabeticals, and related searches.
- Keyword Surfer (<https://chrome.google.com/webstore/detail/keyword-surfer/bafijghppfhdpdihckdcadbcbikaca?hl=en>) – is a free Chrome extension that shows estimated global and local (for 19 countries including Canada) monthly search volumes for any query typed into Google.
- Keyworddit (<https://www.highervisibility.com/free-seo-tools/keyworddit/>) – pulls keyword ideas from Reddit.
- Questiondb (<https://questiondb.io/>) – finds the questions people are asking about a specific topic (sourced from Reddit).
- Bulk Keyword Generator (<https://www.highervisibility.com/free-seo-tools/bulk-keyword-generator/>) – is a keyword research tool for *local* SEO. It generates keywords based on industry type.

You can also conduct a Google Search using your keywords, phrases, and questions and look at the results. Pay attention to the “People also ask” box for search suggestions. Now that you have a better sense of what on-site SEO covers, let’s take a look at off-site SEO.

Off-Site SEO

Off-site or off-page SEO involves any activities that drive awareness and referral traffic **to** your website from other sites. For example, if you have a link to your website in your Twitter profile, there is now a link from Twitter back to your website. The reason this is important is because search engines will rank a website based on the reputations of those websites linking to it. So, if you have links from industry associations, media sites, educational institutions, etc. linking to your website, search engines will rank your website much higher than links from smaller or less reputable websites. These external websites become part of your “online digital network / family” and directly influence your website’s “reputation”. As a result, link building is often considered the main off-site tactic and can include tactics such as:

- Guest blogging
- Content marketing
- Social media marketing
- Image / video sharing
- Podcasts and articles
- Customer Reviews
- Directory listings, etc.

Some key considerations and concepts for off-site SEO include:

- **Outbound Links**

Outbound links are links from your website to websites with a different domain name. When you make these connections, keep in mind that the other website will become part of your website network. In other words, your reputation and their reputation are now linked.

- **Inbound Links / Backlinks**

The opposite of outbound links, inbound or backlinks come from other websites with a different domain name and point to your website. To improve your off-site SEO, increase the number of relevant, related websites that link to your website. Keep in mind that recent links rank higher than older links and it is still important to have keywords in any link text, as mentioned above. If, for some reason, you discover a website linking to yours and want to remove that connection, you can make use of **Google's Disavow Tool** (<https://support.google.com/webmasters/answer/2648487?hl=en>).

- **Content**

Creating content is a significant part of any off-site SEO strategy. However, not all content is equal. For search engine purposes, high quality content is defined as original, recent, accurate, few grammar mistakes, appropriate length, and unique. Websites that produce higher-quality content will rank higher in search engine results. So, a robust content marketing strategy helps an organization's off-site SEO, especially for newer websites that are establishing their credibility and building an audience.

- **Link diversity**

To improve your off-site SEO, create a variety of outbound and inbound links, i.e., to and from a variety of *different* domains. Link diversity increases your off-site SEO ranking.

- **Social signals**

Be sure to include links to your website in your social media profiles and posts. And encourage your followers, employees, strategic partners, etc. to post and link to your content so that you build your link network.

For more ideas on link building strategies, please read this article, **15x Incredible Link Building Strategies** (<https://www.matthewwoodward.co.uk/seo/link-building/strategies/>) or watch the following YouTube video:



One or more interactive elements has been excluded from this version of the text. You can view them online here: <https://opentextbc.ca/foundationdigitalmarketing/?p=80#oembed-1> (#oembed-1)

Key Takeaways

On-site and off-site SEO significantly impact your search engine results:

- Think about the terms, words, phrases, and questions that your target audience will use to search for answers and your solutions.
- To improve on-site SEO, consider incorporating keywords into many of the structural elements of the webpage, e.g., title tags, meta description, etc., as well the visible content and files.
- A key element of off-site SEO is link building. Marketers need to create meaningful connections (links) to a variety of relevant and related websites to increase their off-site SEO ranking.

SEO – Additional Resources

To dive into SEO in more detail, here are some additional online resources:

- The Beginner’s Guide to SEO (<https://moz.com/beginners-guide-to-seo>) (7 Chapters – Moz)
- SEMrush SEO Toolkit (<https://www.semrush.com/academy/courses/seo-toolkit-course/organic-research>) (3 hrs. – SEMrush)
- SEO Fundamentals Course with Greg Gifford (<https://www.semrush.com/academy/courses/seo-fundamentals-course-with-greg-gifford>) (4 hrs. – SEMrush)
- SEO Marketing with Ahrefs (<https://ahrefs.com/academy/marketing-ahrefs>) – (5hrs. – Ahrefs Academy)

Media Attributions

- SEO (<https://www.pngall.com/seo-png/download/14004>) by Rojal is licensed under a CC BY-NC 4.0 licence. (<https://creativecommons.org/licenses/by-nc/4.0/>)
- Google is trademarks of Google LLC and this book is not endorsed by or affiliated with Google in any way. Used with permission (<https://about.google/brand-resource-center/guidance/media/>).
- 11 Powerful SEO Link Building Strategies For 2021 (<https://www.youtube.com/watch?v=Rrh974qmbjk>) by IgniteVisibility (<https://www.youtube.com/user/IgniteVisibility>) is licensed under a Standard YouTube License.
- Anatomy of a web page by Rochelle Grayson is licensed under a CC BY 4.0 licence.

11.

Website and Landing Page Optimization

Learning Objectives

By the end of this chapter, you should be able to:

- **Conduct** a website audit
- **Describe** the key elements of a successful landing page

Website Optimization

Now that you've learned the basic approaches behind **SEO**, let's look specifically at website optimization. As with any marketing strategy, the first question to ask is: who is the audience you are optimizing your website for? Website content often needs to support several audiences and each audience has slightly different content requirements. Here is a list of common target audiences for a website:

- **Customers**
The most common audiences would be potential and existing customers, i.e., those customers represented by your customer personas. When optimizing for these audiences you want to make sure your content is addressing their wants, needs, pain points, goals, and objectives.
- **Strategic Partners, Alliances, Vendors**
Many organizational websites also include content for strategic partners and vendors. For example, this could be suppliers, funders, investors, etc. The needs and content required for these audiences tends to differ from target customers. Given the distinct needs of these audiences, what specific content or information should be available for them?
- **Search Engines**
As we discussed in the **SEO** chapter, preparing your website so that search engines can find, read, and index your content requires yet another approach. If you are wondering which search engines to optimize for, according to the **most recent statistics by Statcounter**¹, Google represents ~92% of searches and Bing is a distant second with ~3%. This is why most SEO is focused on Google.

1. Search Engine Market Share Worldwide (<https://gs.statcounter.com/search-engine-market-share>)

- **Your Organization / Brand**

Your website may also be a source of information for your employees and for customer support. Do you have a self-serve support section? Or do you have a place where employees can discover the latest news to share with their networks? Remember, in our **POEM framework**, that employees are also considered “owned media” and can promote organizational content, as well.

Based on the above audiences, optimizing your website content will vary depending on which audiences you prioritize. So, identify, define, and rank your target audiences first.

5-Step Website Audit Process



The above image highlights a 5-Step Website Audit process that covers the critical stages in a optimizing your website:

1. Competitive Analysis
2. Technical Errors
3. SEO
4. Customer / User Experience

5. Design

Step 1: Competitive Analysis

Before optimizing your own website, do take time to review your competitors' websites. Marketers can glean a great deal of information from this process. For example, it can be beneficial to understand the keywords your competitors are using, how content is organized and presented, who is visiting their website, and provide additional digital marketing ideas to better market your own solutions.

To perform a competitive analysis, there are many free competitor analysis tools. These can give you quick and valuable insights, and many services offer paid, premium versions, as well. The following table presents several competitive analysis tools and lists their features across a variety of areas: search optimization, digital advertising, link authority, social media, traffic, and technology.

Competitive Analysis Tools and Their Features

Tool	Rankings	Advertising	Authority	Social Media	Traffic	Technology
Ahrefs	✓	–	✓	–	–	–
Alexa	✓	✓	✓	–	✓	–
Builtwith	–	–	–	–	–	✓
Buzzsumo	–	–	✓	✓	–	–
FollowerWonk	–	–	–	✓	–	–
iSpionage	✓	✓	–	–	–	–
Majestic	✓	✓	✓	–	–	–
Moat	–	✓	–	–	–	–
MOZ / Link Explorer	–	–	✓	–	–	–
Quantcast	–	–	–	–	✓	–
SimilarWeb	✓	–	–	✓	✓	–
Searchmetrics	✓	✓	✓	–	–	–
SEMrush	✓	✓	✓	✓	–	–
Serpstat	✓	✓	✓	✓	–	–
SpyFu	✓	✓	✓	–	–	–

Each tool evaluates different aspects of digital marketing and website criteria. So, let's look at each one of these in more detail:

Keyphrases and Search Engine Rankings

What do they rank for?

Seeing what your competitors rank for and how high will immediately provide ideas for content and keyphrases. Without using a tool, the only way to find this information would be to search for every conceivable keyphrase.

Pay Per Click and Digital Advertising

What phrases are they bidding on? Where are they investing their ad budgets? What do their ads look like?

Like organic rankings, understanding a competitor's ad spending will provide insights into what might be a good investment for you. Assuming they have well-managed, well-optimized ad campaigns, you can see which words and phrases are getting traction with your target audiences.

Authority and Link Popularity

Do they have higher quality and more authoritative links than us?

As discussed in the **SEO** chapter, links can signal a website's value. Sites with many links from other relevant and related websites will likely have higher authority, especially if the links are from sites that have high authority themselves.

Beyond the number, you can also use these reports to find marketing opportunities. For example, if a media site or blog has mentioned and linked to a competitor, it may be a good site to promote or write about your solutions.

There are many tools that track links and provide authority metrics. Each service has a distinct name for the number, but essentially, they all measure the same thing: *the likelihood of ranking on a scale from 1 – 100.*

- MOZ: Domain Authority
- SEMrush: Domain Score
- Alexa: Competitive Power
- Ahrefs: Domain Rating
- Searchmetrics: Page Strength

Social Media

Which of their articles is getting shared the most? Who is sharing their content?

Social media accounts are easy to follow, but hard to analyze. You may be able to see which specific posts are getting engagement, but the bigger picture is difficult to see without tools. So, using these tools can be very useful and spark ideas for what to write about, where to be active, and who to collaborate with.

Traffic

Are they getting more traffic?

There are no tools that will provide an accurate look into your competitor's analytics. But there are ways to get website traffic estimates. Some of the above tools can provide an overview into who is getting more visitors, when they visit, demographics and behaviour data. This data can be quite helpful in completing your customer personas.

Technology

What technology is their site built on and what tools are they using?

Website technology is surprisingly visible, and there are services that can find out exactly what is powering your competitor's website, as well as what additional tools and plugins are being used. This can potentially provide information about what tactics your competitors are using and what might work well for you.

Step 2: Technical Errors

Now that you have reviewed your competitors' websites and possibly have ideas about how to improve your website, let's take a look at the most common technical errors that might exist on your own website:

- **HTTPs Status**
Make sure that your website has a TLS/SSL certificate. Websites secured with a TLS/SSL certificate will display HTTPS and the small padlock icon in the browser address bar. An HTTPS connection indicates that your website is secure and that communications between your web browser and the web application are encrypted. Having a secured website impacts your search engine ranking because websites with TLS/SSL certificates rank higher.
- **Page Speed Test**
According to recent research, if your site takes more than 3 seconds to load, you lose 75% of your potential readers. Therefore, it is crucial to make sure your webpages load quickly. A recommended tool to test for webpage load speeds is Google PageSpeed Insights².
- **Broken Images and Links**
Links are quite important to your SEO. However, broken links undermine these efforts and decrease your site's search engine ranking and user-friendliness. So, removing any broken images and links, i.e., links that no longer resolve to a valid webpage, is an easy way to improve your search engine ranking.
- **Mobile Optimization**
Is your website optimized for a mobile experience? Being mobile friendly improves the user experience and increases your site's ranking.

2. Google PageSpeed Insights (https://pagespeed.web.dev/?utm_source=psi&utm_medium=redirect)

Since these technical errors are easy to detect, using a site auditor tool is highly recommended. Once again, here is a list of website audit tools that can be useful:

Website Audit Tools

Name	Price	Features
Hubspot Website Grader ³	Free	<ul style="list-style-type: none"> • Basic tool to quickly check your website
Hotjar ⁴	15-Day Free Trial \$99+ per month	<ul style="list-style-type: none"> • One domain • Visitor Recordings – helps understand visitor behaviours • Heat Maps – helps to understand what sections of the page are the most popular
Google Search Console ⁵	Free	<ul style="list-style-type: none"> • Shows errors on the pages • Helps to monitor search performance
Serpstat ⁶	\$69 – \$499 per month	<ul style="list-style-type: none"> • Unlimited number of domains • Complex audit with a website audit report that lists the detected issues and provides recommendations on how to fix them
RAVEN Site Auditor ⁷	\$39 – \$399 per month	<ul style="list-style-type: none"> • From 2 to 320 domains • Can audit 150,000 to 2,500,000 pages • Complex audit KPI tracking
SEMrush Site Auditor ⁸	\$99.95 – \$399.95 per month	<ul style="list-style-type: none"> • From 3 to 25 domains • Up to 20,000 pages to audit • Complex analysis • Comparison with competitors' websites
WebCEO (https://www.webceo.com/website-audit.htm) Site Auditor ⁹	14-Day Free Trial \$99 – \$299 per month	<ul style="list-style-type: none"> • From 1 to 30 domains • Can audit 100 to 150,000 pages • Complex audit, including media activity

3. Hubspot Website Grader (<https://website.grader.com/>)

4. Hotjar (<https://www.hotjar.com/>)

5. Welcome to Google Search Console (<https://search.google.com/search-console/welcome>)

Step 3: On-Site & Off-Site SEO

On-site and off-site SEO represent the next step in the framework. Summarizing the details covered in the **SEO** chapter, you will want to improve your on-site and off-site SEO by addressing the following key areas:

- **Keywords, Phrases, & Questions**

Identify and build a comprehensive list of appropriate keywords, phrases, and questions that your target audiences might use. Many of the previous steps in this 5-Step Website Audit process should assist in compiling this list.

- **Structural Elements of Webpages**

Make sure to update and include your keywords into the structural elements of your webpages.

(click on the pluses below for details)

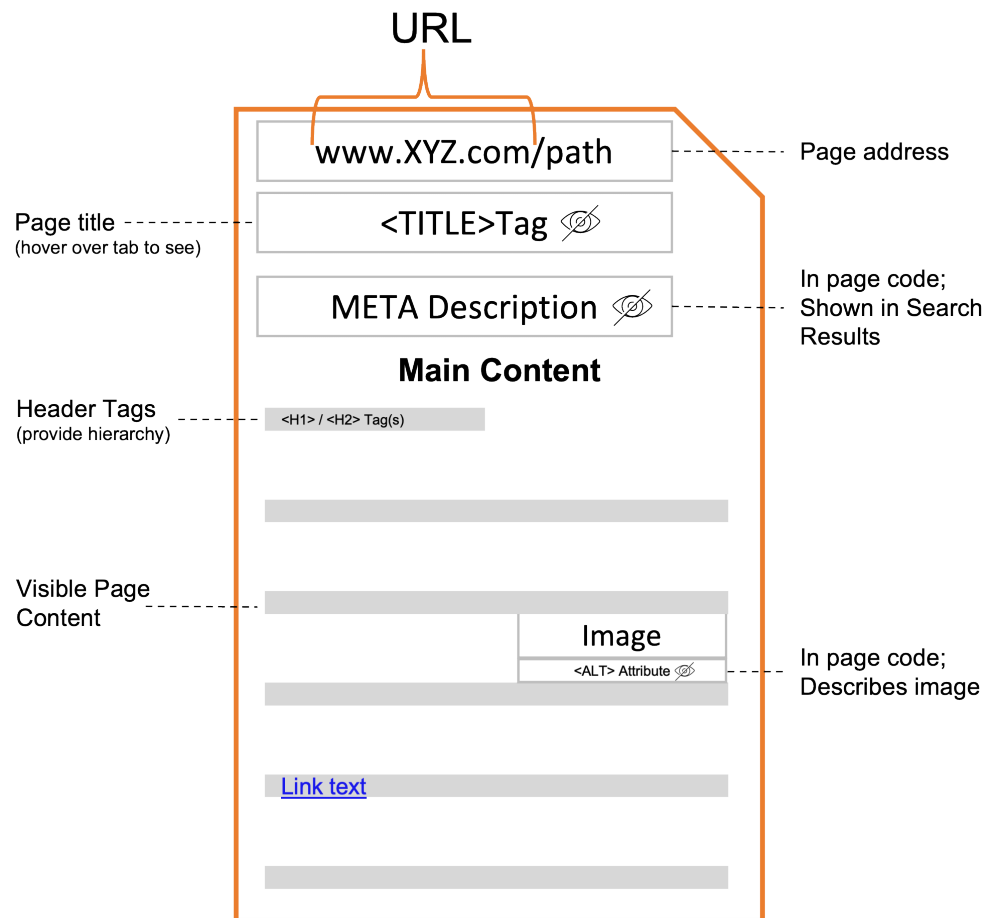

- **Link Building**

Implement a comprehensive **content marketing** and link building strategy to increase your link network and ultimately, improve your link authority. Especially for newer websites,

6. Serpstat (<https://serpstat.com/>)

7. RAVEN Site Auditor (<https://raventools.com/site-auditor/>)

8. SEMrush Site Auditor (<https://www.semrush.com/siteaudit/>)

9. WebCEO Site Auditor (<https://www.webceo.com/website-audit.htm>)

developing content using keywords will usually provide more SEO benefits than simply trying to get backlinks. So, think about getting backlinks *based* your content, not just links on their own.

Step 4: Customer & User Experience (CX / UX)

Now that you have identified your audiences and the appropriate content, let's look at the experience of accessing and discovering that content. According to Wikipedia (https://en.wikipedia.org/wiki/User_experience):

The user experience is how a user interacts with and experiences a product, system, or service. It includes a person's perceptions of utility, ease of use, and efficiency.

Given the above definition, let's look at how your website contributes to your customer experience and what areas you should evaluate:

- **Simple / easy-to-use navigation**

This may seem obvious, but many websites are so complicated and have so much content that it can be difficult to find the content you want. When reviewing your website, think about the following questions:

- ***How many clicks / scrolls does it take to get to the relevant information?***
Be careful about assuming what visitors see. This is particularly important when thinking about the mobile vs. desktop experience.
- ***Is the navigation “intuitive”, i.e., does it follow “standard” navigation practices?***
When we go to a new website, there are standard navigation expectations and does your website follow them? For example, is the account login link in the top, right-hand corner of the webpage or is there a navigation menu at the top?
- ***Is there a search bar?***
There are generally two types of visitors: browsers and searchers. Browsers will browse their way through a website, clicking on links to discover and explore what the website offers. In contrast, searchers know exactly what they want to find and are looking for specific information or answers. Having a search bar allows searchers to more easily find what they want without have to unnecessarily click around the website.

- **“Unnecessary” obstacles / hurdles**

Marketers often want to convert visitors as quickly as possible when on their website. This can result in “interruptions” like pop-ups, which marketers may use to get visitors to sign-up for something or to promote an offer. When launching this strategy, think about your goals and objectives and ask: will these tactics attract our target customers and how valuable or long-lasting are these conversions? Also, look at your bounce or exit analytics because you may see that these tactics are more disruptive than helpful, i.e., you are pushing leads away. Use the following tactics carefully and not too frequently:

- **Pop-ups** (*can be especially problematic on mobile*)
- **Automatic Live Chat pop-ups**

- **Relevant and credible content**

Based on the previous steps, prioritize your content. Make sure the content you are presenting is relevant and credible to your target audiences. It should answer and provide solutions to target customers' questions, pain points, and challenges. Make sure your content is organized and addresses the following:

- **Hierarchy**

Content hierarchy refers to the location of content on your website and webpages. For example, the most important content should be available on initial entry pages and preferably, at the top of those pages. When visitors come to your website or webpage, the most important information should be easily visible and available without significant scrolling or clicking required.

- **Social proof**

Be sure to include testimonials, customer logos, certifications, etc. to highlight your credibility, industry leadership, and expertise.

- **Clear calls-to-action (CTAs)**

And, finally, for an optimal customer experience, make sure that all links, buttons, and any other calls-to-action are clear, consistent, and stand out.

A poor customer experience negatively impacts your entire customer journey. So, review and optimize all audience experiences to make them as easy and seamless as possible. For a nice overview on navigation, hierarchy, and colour (which we will discuss in the next step), you can watch the following video:

Watch: Key Web Design Principles: Navigation, Hierarchy & Color (11:30 mins) (<https://youtu.be/GJN7TemsZtY>)



One or more interactive elements has been excluded from this version of the text. You can view them online here: <https://opentextbc.ca/foundationdigitalmarketing/?p=83#oembed-1> (#oembed-1)

Step 5: Design

In this next step, we will briefly discuss a few website design areas that can help optimize your website experiences. Having a well-designed, well-laid out website can positively impact your visitors' perceptions of your content and brand. Here are a few design areas you may want to review as part of your website audit:

- **Design Consistency**

Since websites are literally living documents, consistency of design elements makes it easier for visitors to understand and navigate them. Inconsistencies are usually a result of design standards or preferences changing over time and/or a variety of people creating content using different standards. As a result, it is important to audit your website and review the following design elements to make sure they are consistent:

- **Fonts**
Make sure that your fonts and font sizes are consistent. Especially look for any fonts that might be too small, keeping in mind the mobile experience. Often what looks fine on a desktop, may not work well on a mobile device.
 - **Imagery**
Try to stick to similar **types** of imagery. For example, mixing animated images or clip art with real-world photos can create an inconsistent website design. Pick a style of images and/or icons and stick to them.
 - **Colours**
Make sure that your website colours are on brand. If possible, work from a defined colour palette or brand guidelines so that there is consistency around which colours are used and for which purposes.
 - **Layouts**
Using website templates can ensure that your layouts are consistent. However, if your website has sub-sections, e.g., a customer support portal, do make sure that it has consistent navigation and allows for easy navigation between sections.
 - **Calls-to-Action (CTAs)**
As mentioned above, make sure that your calls-to-action are designed in the same way so that they are recognizable as calls-to-action, e.g., colour, size, font, shading, borders, etc.
 - **Brand voice**
Is the voice of your brand consistent throughout your website? Again, if multiple people have been maintaining the website content, there may be areas that need rewriting or updating.
- **Whitespace**
An area often overlooked in website design is whitespace. **Whitespace** is the “empty” or blank space between content on a webpage. Having ample whitespace makes the content easily scannable and can significantly improve comprehension.

Please note that website design is a complex, detailed discipline. The above design considerations are simply a few high-level areas that can have a significant impact on your website optimization.

Landing Pages

Now that you know the key areas to consider as part of a website audit, let’s take a look at a very specific type of webpage called a landing page. In digital marketing, a **landing page** is typically a standalone webpage, created specifically for a marketing or advertising campaign. A landing page is where a visitor “lands” after clicking on an ad or a link. Landing pages can be existing pages on your website, but when planning a marketing campaign, marketers usually prefer to have a landing page with specific messaging, imagery, and often, a unique call-to-action, e.g., book an XYZ demo, etc.

Landing pages are designed to maximize conversion. As a result, they often minimize the number of links and other website navigation options. This is referred as the attention ratio. The **attention ratio** is

the number of things a visitor *can* do on a page relative to the number of things they *should* be doing. In an optimized marketing campaign, the attention ratio of a landing page should be 1:1. Since every campaign has one conversion goal, every corresponding landing page should only have one call to action, i.e., one place to click. In comparison, a typical home page, may have 10 – 15 calls-to-action. But, as the attention ratio goes up, i.e., more links to click on, conversions go down. So, for an optimal conversion experience, marketers will want to limit the number of click options on their landing pages.

Building on this optimization strategy, let's look at which elements should be included in an optimized landing page. Generally speaking, there are five key elements to any successful landing page. The following image presents these elements on a generic landing page:

(click on the pluses below for details)

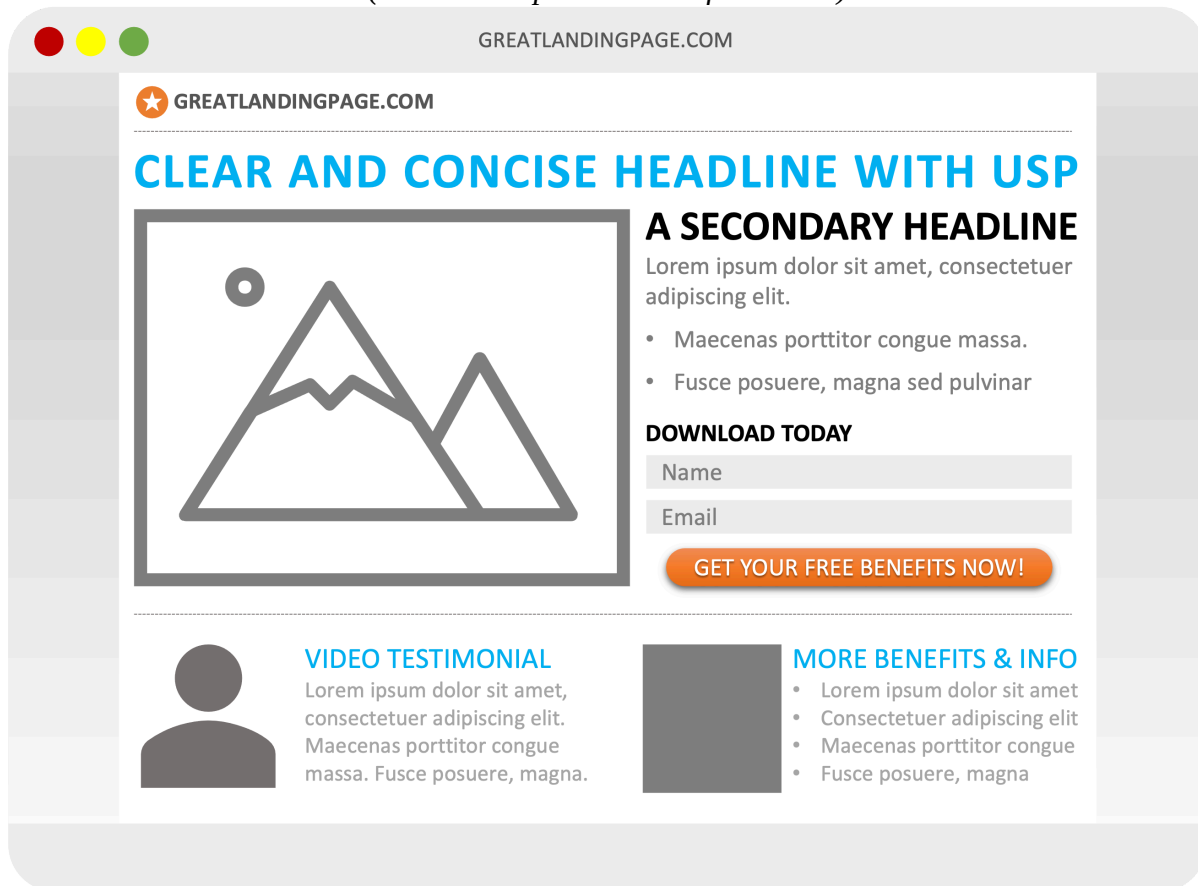

1. **Clear unique selling proposition (USP)**

Your unique selling proposition differentiates your offer from the competition's and should highlight what is compelling about your offer. To ensure your target audience understands your USP, be sure to include it in your main headline, any supporting headlines (if present), and in a closing argument before asking for the conversion / call-to-action.

2. **Engaging hero shot**

A hero shot is a visual element that represents your offer and helps your target audience better understand what you are offering or what it looks like. It could be an image, video, or any other visual media type.

3. **Compelling benefits**

Often marketers will list the features of their offer. Try to rework your features and present them as benefits your target audience will receive. A feature is what something is, and a benefit is what users can do or accomplish with it. On your landing page, answer **how** your target audience will benefit from your product or service. Let's walk through a quick feature-benefit example:

Product: mobile phone

Feature: a battery pack with 2000 mAh capacity

Advantage: a powerful, long-lasting battery

Customer benefit: Increase your phone's battery life by up to 50% so you can enjoy 3D gaming on your long commute without worrying about the battery running out.

0. **Inspirational social proof**

As discussed, social proof highlights other people or organizations that have bought, consumed, read, participated in, and ideally, succeeded using what you are offering. Common social proof examples include testimonials, customer logos, industry certifications, awards, etc.

5. **Strong call-to-action (CTA)**

The goal of every landing page is to convert; always ask for the conversion with a strong call-to-action that highlights the benefits the visitor will receive.

For more details and examples, please review this Unbounce article, [The 5 Essential Elements of a Winning Landing Page \(https://unbounce.com/landing-pages/elements-of-a-winning-landing-page/\)](https://unbounce.com/landing-pages/elements-of-a-winning-landing-page/).

Key Takeaways

Website and landing page optimizations are critical to successfully convert prospective customers. By performing a 5-Step website audit and optimizing your landing pages, you can significantly improve your customer experiences, as well as increase campaign conversions.

- The five key stages of a website audit are:
 1. Conduct a competitive analysis
 2. Identify any technical errors
 3. Implement an SEO strategy
 4. Evaluate the customer / user experience
 5. Review the website design
- The five elements of a successful landing page include:
 1. Clear unique selling proposition (USP)
 2. Engaging hero shot
 3. Compelling benefits
 4. Inspirational social proof
 5. Strong call-to-action (CTA)

Website & Landing Page Optimization – Additional Resources

In addition to the resources listed in the chapter, here are a few more articles and courses that provide additional details:

- 15 Step Website Audit Checklist (<https://www.seoptimer.com/blog/website-audit-checklist/>) (& PDF Template)
- The 10-Step SEO Audit: How to Find Your SEO Mistakes & Opportunities (<https://www.wordstream.com/blog/ws/2018/06/20/seo-audit>)
- How to Do a Basic Website Audit to Improve SEO and UX (<https://ahrefs.com/blog/website-audit/>)
- How to Perform an SEO Audit in 18 Steps (<https://www.semrush.com/blog/seo-audit/>)
- 10 Free Keyword Research Tools (<https://ahrefs.com/blog/free-keyword-research-tools/>)
- 10 Tips to Improve Your Website’s User Experience (<https://adoric.com/blog/10-tips-to-improve-your-websites-user-experience/>)
- How to Improve Your Website’s UX (<https://accesspressthemes.com/blog/how-to-improve-ux-of-your-website/>)
- 8 Simple UI UX Design Tips for Web Designers (<https://parachutedesign.ca/blog/8-simple-ui-ux-design-tips-web-designers/>)
- 10 User Testing Tools to Try (<https://blog.hubspot.com/blog/tabid/6307/bid/30557/6-guidelines-for-exceptional-website-design-and-usability.aspx>)
- Unbounce Landing Page course (<https://thelandingpagecourse.com/>) (Free – 3 hrs.)

Media Attributions

- 5-step website audit process by Rochelle Grayson is licensed under a CC BY 4.0 licence.
- KEY Web Design Principles: Navigation, Hierarchy & Color (<https://www.youtube.com/watch?v=GJN7TemsZtY>) by Flux Academy (<https://www.youtube.com/c/FluxWithRanSegall>) is licensed under a Standard YouTube License.

12.

Paid Advertising and Search Engine Marketing

Learning Objectives

By the end of this chapter, you should be able to:

- **Explain** key paid advertising concepts, structures, & terminology
- **Describe** the basics of keyword bidding
- **List** the different types of Google Ads

Basic Terminology and Calculations

There are many paid advertising options in digital marketing. However, before we delve into specific techniques and processes, let's review some basic terminology and calculations:

- **Search Engine Marketing (SEM)**
Often used interchangeably with paid advertising, search engine marketing is actually the practice of maximizing marketing results from search engines. While this does include paid advertising, it also covers organic SEO, as well. So, search engine marketing is the umbrella concept that includes all marketing efforts – paid or unpaid – that maximize an organization's search engine results.
- **Impressions**
Impressions represent how many people have been exposed to (“seen”) an ad.
- **CPM**
CPM is the cost to an advertiser for every 1,000 (*Latin: “mille”*) impressions. In other words, this is the price advertisers pay for every 1,000 **views** of a specific ad.
For example, if your budget was \$500 and that delivered 25,000 impressions, your CPM would be $\$500 \div (25,000 / 1,000) = \20 . Remember that CPM are measured in 1,000 impressions. Meaning if the total forecasted impressions are 25,000, you'll need to divide this by 1,000 to calculate your CPM. Because this pricing model charges for every view, regardless of whether the person clicks on it or not, the rates (per 1,000) are often the lowest. The use of CPM campaigns is relatively rare since it is not connected to specific actions or results. However, marketers may still use it for branding or awareness campaigns because they can potentially get their message in front of large audiences at lower rates. According to TopDraw (<https://www.topdraw.com/insights/is-online-advertising-expensive/>), the following CPM rates represent averages across a variety of online advertising platforms:

Average CPM Rates in 2021

Platform	Average CPM*
Google Search Ads	\$38.40
Google Display (Banner) Ads	\$3.12
Facebook Ads	\$8.60
Instagram Ads	\$8.96
Twitter Ads	\$6.46
LinkedIn Ads	\$6.59
Pinterest Ads	\$30

* Please note the above amounts are averages. CPM rates will vary significantly depending on the focus of your target audience. So, if you are targeting the world, for example, you will be quoted a much lower CPM rate because the audience is quite general and diverse. However, if you want to target potential customers in a specific country, geographic region, industry, or with specific interests, CPM rates can increase dramatically.

- **Cost Per Click (CPC)**

Cost per Click is the cost to an advertiser for each click on an ad. In other words, an advertiser only gets charged when someone *clicks* on their ad – not a view like CPM. Since a click indicates initial interest, marketers will generally pay more for these types of ad campaigns. CPC campaigns tend to represent the majority of paid advertising campaigns. For budgeting purposes, let's assume, once again, you have a \$500 budget. And the forecasted CPC rate for your target audience is \$2.00. Based on these figures, your budget would cover a maximum of 250 clicks = \$500 / \$2.00. Once again, here are some average CPC rates from TopDraw¹:

Average CPC

Platform	Average CPC*
Google Search Ads	\$2.32
Google Display (Banner) Ads	\$0.67
Facebook Ads	\$1.35
Instagram Ads	\$3.56
Twitter Ads	\$0.38
LinkedIn Ads	\$5.26
Pinterest Ads	\$1.50

1. TopDraw - Online Advertising Costs In 2021 (<https://www.topdraw.com/insights/is-online-advertising-expensive/>)

* Like the above CPM rates, please note the CPC amounts are averages. CPC rates will also vary depending on the focus of your target audience. So, if you are targeting a broad audience, you will be quoted a much lower CPC rate. However, if you plan to target potential customers in a *specific* country, geographic region, industry, or with specific interests, CPC rates will often be higher.

- **Cost per Action / Acquisition (CPA)**

Cost per Action (sometimes referred to as Cost per Acquisition) measures how much an advertiser pays to get a “conversion”. Conversions are desired actions that people perform *after* clicking on an ad, such as making a purchase, downloading some content, booking a demo, etc. Since these CPA activities involve multiple steps, e.g., clicking on the ad, purchasing a product or service, and/or maybe filling out a form, they are the most costly. But, if potential customers do complete all these conversion activities, it is clearly worth more to the advertisers.

Because the scope of these conversions can vary significantly, CPA rates also fluctuate. For example, an automotive dealership, might be willing to spend \$250 for someone to sign-up for a test drive. But a marketer offering a downloadable PDF template, where you fill out a form, might only be willing to spend \$25 dollars for that contact information. Both examples are valid conversions; but depending on what is being offered and the value it provides to the advertiser, the CPA rate will differ.

- **Click-through Rate (CTR)** represents the percentage of people who have been exposed to an ad (or link) AND clicked on it, therefore visiting the landing page or destination of the ad / link. It is calculated by dividing the number of clicks by the number of impressions, i.e., **clicks ÷ impressions**.

If an advertiser’s ad had 15,000 impressions and there were 50 clicks, the click-through rate (CTR) would be $50 / 15,000 = 0.0033 = 0.33\%$. Now a common question asked is what is a “good” click-through rate? The most appropriate answer to this question is: it depends. Many factors can influence your CTR, such as:

- Industry
- Type of ad, e.g., search (text), display, video, etc.
- Host platform, e.g., Google, Facebook, Bing, LinkedIn, etc.
- Your AdRank, which is a metric that determines the position of your ad and how often it gets shown. We’ll dive into this later.

That said, in general, search (text) ads have an average CTR of approximately 2% and display (banner) ads have a CTR of 0.35%. But again, this can vary widely by industry. For example, search ads in the legal industry have an average CTR of approximately 1.4% and dating ads have an average CTR of 3.5%.

- **Conversion Rate** is calculated by dividing the number of conversions by the number of people who clicked on your ad, i.e., **conversions ÷ ad clicks (or visitors)**.

In our previous example, there were 50 clicks on the ad, which meant that your landing page received 50 visitors. If one of those 50 visitors converted, the conversion rate would be $1 \div 50 = 0.02 = 2\%$. Please note that the conversion rate *usually* is not based on the number of impressions, but rather the number of actual visitors. That said, if you do plan to define your conversion rate differently, be sure to clarify your inputs and make sure everyone in your

organization is using the same formula. Once again, industry conversion rates will vary largely because the customer buying decision process and level of commitment differ widely. For example, deciding on subscribing to a software-as-a-service (SaaS) solution is different from deciding to buy a pair of jeans. Therefore, you should try to compare your conversion rates to your specific industry as a baseline. For a variety of benchmarks, you may want to read this Alexa blog post, Average Conversion Rates by Industry, Ad Provider, and More (<https://blog.alexa.com/average-conversion-rates/>).

Now that you have learned about some fundamental paid advertising concepts, let's try a few PPC math exercises to make sure you understand how they relate to each other:

1. With a budget of \$1000, an average CPC of \$2.50, how many clicks can the advertiser receive before their budget is exhausted?
 - a. 400 clicks
 - b. 250 clicks
 - c. 2,500 clicks
 - d. 0.0025 clicks
2. With an unlimited budget, an average CPC of \$1.00, a CTR of 1.8%, and 60,000 impressions, how much will the advertiser spend?
 - a. \$108,000
 - b. \$1.680
 - c. \$33,333.33
 - d. \$1,080
3. With an average CPC of \$2.00, how high does the conversion rate need to be in order to reach a goal CPA of \$10?
 - a. 20%
 - b. 0.2%
 - c. 5%
 - d. 200%
4. If you have a \$3000 budget, your average CPC is \$0.50, and your conversion rate is 5%, what is your current CPA?
 - a. \$10
 - b. \$1,000
 - c. \$1,500
 - d. \$600
5. If you have a \$3000 budget, your average CPC is \$0.50, and your conversion rate is 5%, how many conversions can you get for \$3000?
 - a. 300 Conversions

- b. 1,200 Conversions
- c. 600 Conversions
- d. 1,500 Conversions

What Is PPC?

One of the most common types of paid advertising is the pay-per-click (PPC) model, which can be applied to text ads, video ads, and even display (banner) ads depending on the options offered by the host advertising platform, e.g., Google Ads, Microsoft Ads, Facebook Ads, LinkedIn Ads, etc. **PPC marketing** is a form of online advertising that allows your organization to appear above organic search results.

Put simply: marketers bid to have their ad appear when people search for specific keywords or key phrases. Whenever the ad appears *and* someone clicks on it, marketers pay for that click – hence the “pay-per-click” name. Marketers often use pay-per-click as part of a lead generation strategy. In other words, marketers pay to get their messages / ads in front of their target audiences. Sometimes, this approach is referred to as “paying for eyeballs”.

How Paid Advertising Works

When a person types a search into an online search engine, there are advertisers interested in showing ads related to that person’s search inquiry. This search triggers an auction, which marketers have previously bid on. The ads that win the auction then appear on the search engine results page. A combination of several variables, including bid amount, the quality of the ad, and quality of the landing page, determine which ad will appear in the top position.

To compete in these public ad auctions, marketers create accounts on these hosted advertising systems like Google Ads to set up their ads and identify where and when they would like for those ads to show up. Since Google Ads is one of the most commonly used Ad networks, let’s take a close look at how marketers set up their advertising campaigns in Google Ads.

Campaigns

Campaign #1
(Budget #1)

Campaign #2
(Budget #2)

Accounts are split into **campaigns** for the convenience of monitoring and reporting on different geographic locations, promotions, types of ads, and/or any other helpful advertising categorization. At the campaign-level, marketers can set their:

- budget,
- language preference(s),

- target location(s),
- type of campaign, and more.

The following lists the most common types of campaigns Google offers:

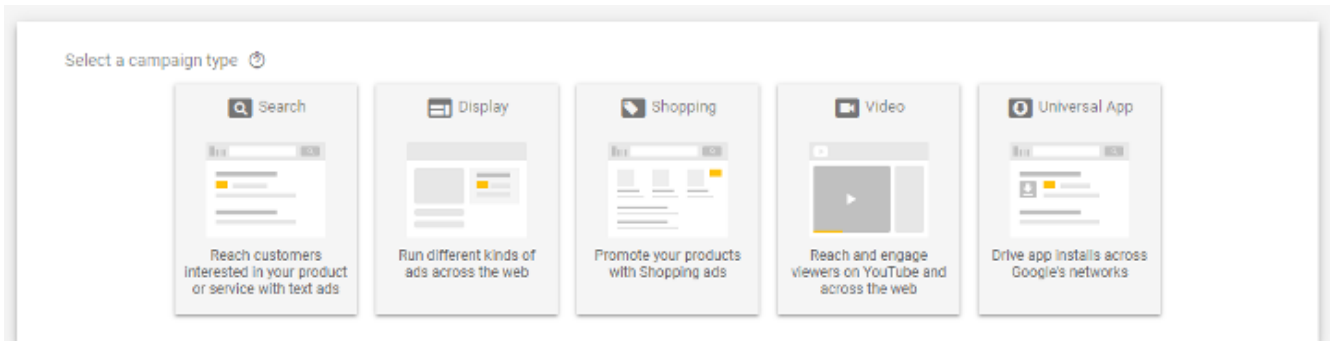

- **Search Campaigns** – Search campaigns present text ads on search results pages, i.e., after someone types in a search key word or phrase. For example, if you were searching for “pizza”, you might see a text ad like the following:
[Example Pizza Store | Best Pizza in Town | Fresh, Hot, & Fast](#)
www.pizzastore.com
Get your favourite pizzas starting at \$5.99! Only at Your Pizza Store!
- **Display (Banner) Campaigns** – Display campaigns are image ads distributed and presented across millions of websites and apps called the Google Display Network. Display campaigns also allow you to follow up with people who have already seen your ads or visited your site (called “remarketing ads”). Here’s an example of pizza display ad:

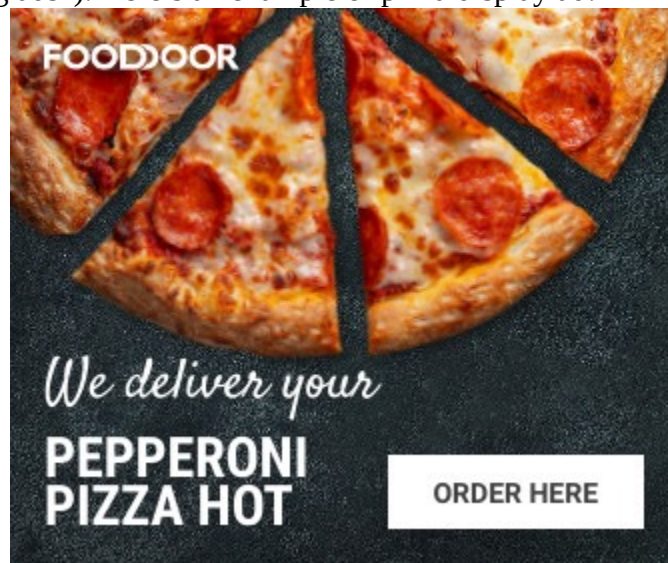

- **Shopping Campaigns** – Shopping campaigns are ideal for retailers looking to sell their product inventory. Shopping ads appear on search results under the Google Shopping tab.

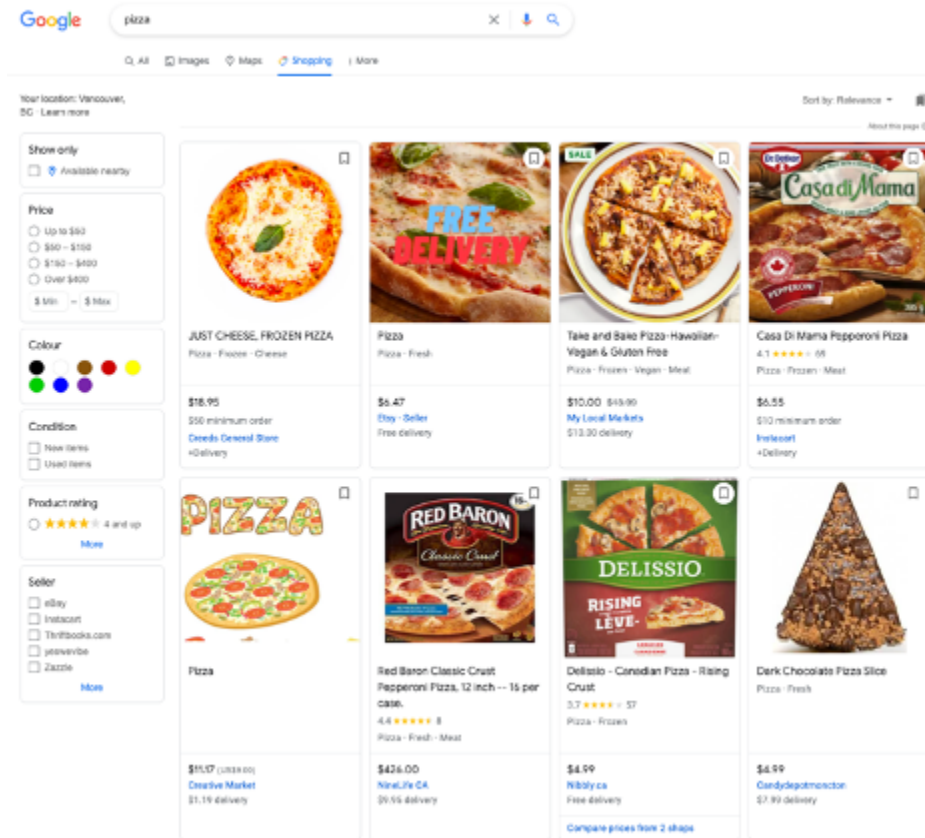

- **Video Campaigns** – Video campaigns let you show video ads on YouTube and other websites.
- **Universal App Campaigns** – Universal app campaigns help you find new app users and increase sales within your app. Unlike traditional Google Ads campaigns, marketers do not need to create individual ads for Universal App Campaigns. Instead, they just add a group of different text lines along with images, videos, or HTML5 assets. Google then generates ads from this inventory of assets. Over time, the platform discovers the best performing ad combinations and shows those ads to users across Google Search, Google Play, YouTube, and/or the Google Display Network.

Google also offers:

- **Local Campaigns** – Local campaigns help bring people to your physical stores and venues. Ads are automatically optimized to appear across Search, Display, Google Maps, and YouTube.
- **Smart Campaigns** – Smart campaigns are an easy way to get your ads up and running. Enter your organization, create a few ads, and Google finds the best targeting to get you the most for your time and money.

For more details on each of these campaign types, review Google's suggestions on **How to Choose the Right the Campaign Type** (<https://support.google.com/google-ads/answer/2567043>).

Ad Groups

As you can see in the image below, each campaign can consist of one or more ad groups. Please note that any setting, e.g., budget, target location, language, etc., set at the campaign-level will be used for **all** ad groups created for that campaign. Each ad group can contain one or more ads which target a shared set of unique keywords.

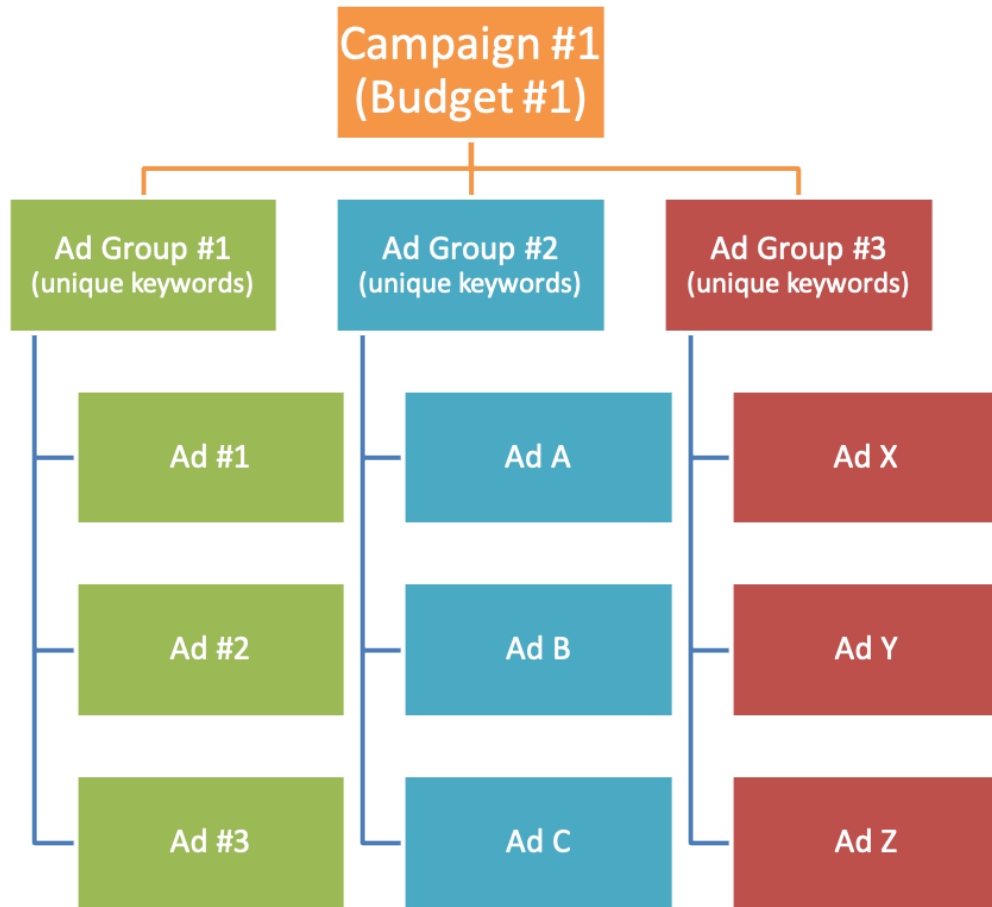

Each ad group contains **unique** key phrases or key words and cannot have the same key phrases or key words as another ad group. Use ad groups to organize your ads by a common theme, such as the types of products or services you want to advertise.

For example, let's say you sell desserts, beverages, and snacks on your website. In the table below, each ad group contains a keyword list focusing on a product you sell. The keyword list in each ad group tells the system to show ads for these products only on searches and websites related to them.

Ad Groups

Ad Group 1: Desserts	Ad Group 2: Beverages	Ad Group 3: Snacks
<ul style="list-style-type: none"> • cupcakes • pumpkin pies • apple pie • chocolate cake • ice cream • cookies 	<ul style="list-style-type: none"> • soda • coffee • iced coffee • iced tea • sparkling water • orange juice 	<ul style="list-style-type: none"> • potato chips • pita chips • beef jerky • salted peanuts • mixed nuts • rice crackers

Queries are the search terms people type into the search box of an online search engine. And as mentioned before, there are three common types of search queries:

- **Navigational Queries** – With these queries, the user wants to visit a specific site or find a certain vendor / brand.
- **Informational Queries** – These are queries that cover a broad topic (e.g., digital marketing or PPC) for which there may be thousands of relevant results.
- **Transactional Queries** – These are queries that indicate an intention to complete a transaction, such as buying something.

Key phrases or words, on the other hand, are what marketers bid on and use to target these individuals by matching their search queries.

Marketers have several keyword matching options when matching search queries:

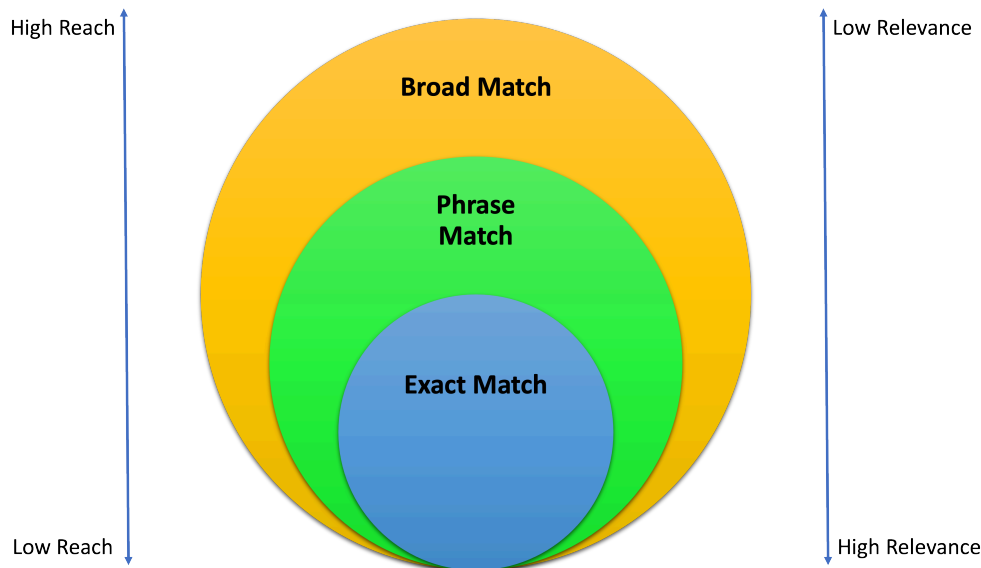

- **Exact Match** (lowest reach, high relevance, high conversion) will show your ad when the search query *has* the same meaning as the keywords you bid on.

- **Phrase Match** (lower reach, medium-high relevance, medium conversion) will show your ad when the search query **includes** the same meaning as the keywords you bid on.
- **Broad Match** (highest reach, low relevance, low conversion) will show your ad when the query **relates** to the keyword. See examples below:

Keyword Match Types

For the keyword **lawn mowing service**, we can match the following queries (🔍)

per match type

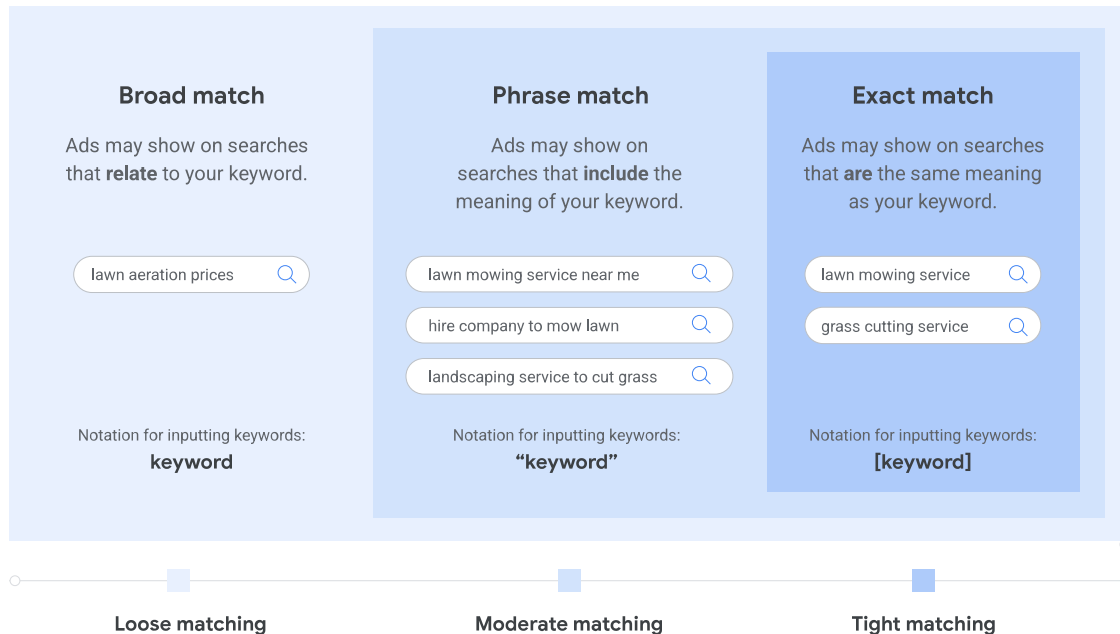

Negative Keywords

It is also possible to choose negative keywords, which prevent your ads from being shown when people type in specific search queries and keywords. This prevents unnecessary clicks (costs) and traffic.

Search / Text Ads

As mentioned above, ads represent a subset of Ad Groups and are usually arranged by common themes. Ads are what people will see if the auction is won, so it is vital to get them right. Ideally, you want to test a variety of ads to see which ones perform best. Each text ad can include up to:

- Three (3) Headlines (max. 30 characters each)
- One (1) Display URL (cannot be changed and is based on the account URL),
- Two (2) URL paths (max. 15 characters each),
- Two (2) Descriptions (max. 90 characters each), and

- Several Ad Extensions

Ad extensions boost the look and usefulness of ads. For example, sitelink extensions link directly to different pages within a website, location extensions map to your location, and call extensions include a telephone number that you can click on during business hours. Ad extensions can be more engaging for searchers and can communicate even more specific information.

In the image below, you can see an example of a Google text ad for the search “pepperoni pizza” highlighting the various elements mentioned above:

The diagram shows a Google text ad for 'pepperoni pizza' with the following elements and annotations:

- Display URL:** Ad · www.pizzapizza.ca/menu_deals/pepperoni_pizza. Annotations: 'Path 1' points to 'menu' and 'Path 2' points to 'pepperoni_pizza'.
- Headlines 1 - 3:** Pizza Pizza | Hot & Fresh | Check Out Our Menu
- Descriptions:**
 - Satisfy Your Cravings, Explore Our Menu. Choose from Pizzas, Wings, Fries, Salads & More.
 - Order Your **Pizza Pizza** Online or On The App Now. Fast Delivery & Special Deals Available.
 - Fast Delivery. Tamper-Proof. Safe & Reliable. Types: Pizzas, Wings, Fries, Salads.
- Location Extension:** 📍 Toronto · 20 locations nearby
- Ad Extensions (Sitelinks):**
 - Pizza Pizza Specials:** Our Exclusive Pizza Specials & More Pizza & Wings Deals For Everybody
 - Medium Pizza Deal:** Get Unlimited Medium 2-Topping Pizzas for \$7.99 Each.
 - View Our Menu:** Classic, Gourmet & Custom Pizzas. Wings, Salads, Fries & Much More.
 - Tamper Proof Pizza Boxes:** Learn More About Our Exclusive Safe Tamper Proof Boxes.

- **Display URL:** Every ad will include **one (1) display URL**. Please note that **the domain name**, i.e., www.YourDomain.com, **cannot be changed** and is based on the domain associated with the Google Ads account.
- **Headlines:** For each ad, marketers can include **up to three (3) Headlines (max. 30 characters each)**. Often, these headlines are separated by a “vertical bar”, e.g., Headline 1 | Headline 2 | Headline 3. Since this is the main headline, be sure to highlight your key benefits and offers, and use keywords to match potential search queries.
- **Descriptions:** Every ad allows for two (2) descriptions (max. 90 characters each). Once again, try to capture the interest and attention of your target audience. Use keywords and key phrases. Highlight your compelling offers and benefits. Showcase the reasons why your solution meets the searcher’s immediate needs.
- **Ad Extensions:** Ad extensions boost the look and usefulness of ads. For example:
 - Sitelink extensions link directly to different pages within a website
 - Location extensions map to your location, and
 - Call extensions include a telephone number that you can click on during business hours.

Ad extensions can be more engaging for searchers and can communicate even more specific information that is easily accessible at the click of a link.

Campaign Budgets & Bidding

To participate in an auction, marketers need to decide how much they are willing to spend. This is done by **setting budgets at the campaign level and bidding at the Ad Group or keyword level**. Budgets set at the campaign level can be organized for a specific period of time, e.g., daily, weekly, or monthly budgets. Budgets should be established according to the overall marketing budget. Bids offer a more specific way of controlling your ad spend.

All Ad Groups need to have bids, but keyword-level bids override Ad Group-level bids. Let's go back to our previous example:

Ad Groups

Ad Group 1: Desserts	Ad Group 2: Beverages	Ad Group 3: Snacks
<ul style="list-style-type: none"> • cupcakes • pumpkin pies • apple pie • chocolate cake • ice cream • cookies 	<ul style="list-style-type: none"> • soda • coffee • iced coffee • iced tea • sparkling water • orange juice 	<ul style="list-style-type: none"> • potato chips • pita chips • beef jerky • salted peanuts • mixed nuts • rice crackers

Let's say you set the maximum bid price for all keyword phrases in Ad Group 1 (Desserts) at \$1. This means that, at most, you would be willing to pay \$1 for any search queries that used: cupcakes, pumpkin pies, apple pie, chocolate cake, ice cream, and cookies. But, if you were bidding close to Thanksgiving, "pumpkin pies" might be especially popular and there might be a lot more competition for "pumpkin pies". To account for this increase in popularity and competition, you could change the (maximum) bid price for "pumpkin pie" to \$1.25 and that would override the \$1 maximum Ad Group bid. Now, your maximum bid price **only** for "pumpkin pies" would be \$1.25. And the maximum bid price for all of the other keywords in Ad Group 1 would remain at \$1.

In terms of bidding, many marketers want to know if they should bid on broad or highly specific keywords. There are trade-offs:

- Broad keywords will bring you more traffic and leads. But bidding on these popular (and competitive) keywords will likely cost more per click and deliver less "qualified" leads. So, these leads will be much more generic and conversion rates will tend to be lower.
- More specific keywords and key phrases will deliver better qualified leads and can cost less, but since they are more specific, there are fewer people who will be searching using these terms. So, they usually produce fewer, but more qualified leads.

Ideally, you want to bid on a combination of both of these because you may be able to convert some of the "generic" leads **and** you definitely want to convert those leads that most closely match your products and services.

Another common question is: How much should I bid on keywords? Unfortunately, this depends a many different factors:

- When keywords or key phrases are **highly competitive**, you can end up spending as much as 2-3x the suggested bid price. A safe starting strategy is to bid 10 – 25% higher than the suggested bid price and work your way up based on your resulting ad rank and position.
- For more specific keywords and key phrases, which tend to have less volume and may have lower competition, start with the suggested bid price and slowly increase your bids to improve your ad rank and position.

Lots of marketers use automated bidding methods. These enable advertisers to set a certain goal for their campaigns and after that have the advertising and marketing system establish the most suitable bid for each auction. Since bidding strategies are very important in getting your ads shown, there are many variables to consider.

Due to the complexities of the bidding systems, the *actual* amount paid by marketers hinges on competitive activity and ad ranking, not simply the highest bid. Your keyword bid represents your maximum bid price. This means you are willing to pay **up to** this price. However, what you **actually** pay depends on what others bid.

For example, if you bid \$2 for “pumpkin pies”, but the next highest bidder had a maximum bid of \$1.50. Then, to win the auction, you only need to pay \$1.51. So, your **actual** cost per click will only be \$1.51 – even though you were willing to pay up to \$2.

Ad Rank

There’s even more to winning the auction than having the highest possible bid. Online search engines look at various other elements to establish which ads get shown at the top of the search engine results page, also called “SERP”.

Online search engines have their very own specific means of factoring in other components to identify ad rank. For example, Google takes the following into consideration:

- Bid price
- Ad relevance and quality
- The context of the search (such as the individual’s device and time of day)
- Design effects (e.g., whether it includes extensions that enhance the ad layout)
- Quality Score – a metric that calculates ad significance

The parts of the Quality Score are:

- Expected click-through rate (CTR) based on historical CTR
- The relevance of the keywords to the ad
- The relevance of the search phrase and ad to the search question

- Landing page quality



$$\text{AdRank} = \text{Your Maximum Keyword Bid} \times \text{Your Quality Score}$$

All of these elements are quite important because the higher the Quality Score, the lower the CPC will be, i.e., the less a marketer needs to pay to have their ad shown. Search engines penalize marketers who bid on keyword phrases with poor Quality Scores by not showing their ads, even if marketers submit high bids.

It is crucial to have engaging as well as relevant ad copy that includes the appropriate keyword phrases. And your landing page quality should not be forgotten either. Ads will be shown less frequently when they point to landing pages that do not deliver on what the ad promises. The landing pages also need to be relevant to the searcher, load rapidly, and provide a good user experience.

Targeting

Picking the best keywords is what enables marketers to show ads to the appropriate audiences. But there are other targeting choices offered to maximize campaign results, including targeting by:

- Device
- Location
- Day and time
- Market or industry

By doing this, marketers can target users on mobile devices in the evening, or users under 25 and within a certain distance of a specific location, to enhance their ad's performance. These are important since variations in ad copy, for instance, might do better for one group of users than for another. Using remarketing tools, marketers can even target or omit previous visitors to a site that do follow-up searches. Bids can also be readjusted for specific keywords based on targeting options, offering marketers much more control over website traffic as well as focusing their bid on those customers, who are more attractive to their organization.

Conversions

The point of all this hard work is not just to get clicks. The real objective is to get conversions. Conversions are those activities marketers want users to complete after clicking on their ad and actions that support the products or services being advertised.

Common examples of conversions include:

- Purchasing a product or service,
- Signing up for an e-newsletter,
- Booking a demo,
- Downloading content,
- and much more.

It is crucial to track conversions to understand whether a PPC campaign is doing well as well as how many conversions can be credited to paid search as opposed to other advertising and marketing channels. Systems like Google Ads can track conversions utilizing a piece of code placed into the source code of the conversion page (*which is reached **after** conversion, like a “Thank you” page*). Conversion monitoring can be difficult since conversion paths also have a tendency to be more complicated than a simple click of an ad and a straight purchase. They typically consist of numerous searches, browsing a variety of related or affiliated websites, or responding to an email, phone call, or in-store promotion. Making use of an analytics solution like Google Analytics can help identify how credit for conversions is attributed to a variety of conversion paths. For more details on marketing attribution, you may want to read the **Attribution** chapter.

Now that you have learned all about PPC, try your hand at creating a PPC advertising campaign:



An interactive H5P element has been excluded from this version of the text. You can view it online here:
<https://opentextbc.ca/foundationsdigitalmarketing/?p=91#h5p-8> (<https://opentextbc.ca/foundationsdigitalmarketing/?p=91#h5p-8>)

Key Takeaways

Paid Advertising allows marketers to reach and target audiences with a great deal of precision:

- Decide which keywords and key phrases you will use in your paid ads and on your landing pages
- Using your customer personas, identify your target audiences on the appropriate ad platforms
- Know your budget
- Pick the appropriate type of ad and craft compelling content with tangible benefits for your target audience
- Align your keywords, ads, and landing pages; this increases your quality score, which can reduce your ad costs
- Structure your campaigns, ad groups, and ads so that each campaign has a clear focus and target audience

Paid Advertising – Additional Resources

The following free courses and articles cover many more advanced paid advertising details across a variety of paid advertising platforms:

- **PPC 101: A Complete Guide to PPC Marketing Basics** (<https://www.searchenginejournal.com/ppc-guide/>)
- **PPC Fundamentals Course with Joel Bondorowsky** (<https://www.semrush.com/academy/courses/ppc-fundamentals-course-with-joel-bondorowsky>) (*Free: 5 hrs. – SEMrush*)
- **Google Ads Certification FREE Courses** (https://skillshop.exceedlms.com/student/catalog/list?category_ids=2844-google-ads-certifications) (Search (<https://skillshop.exceedlms.com/student/path/18128-google-ads-search-certification>), Display (<https://skillshop.exceedlms.com/student/path/18061-google-ads-display-certification>), Video (<https://skillshop.exceedlms.com/student/path/18216-google-ads-video-certification>), App (<https://skillshop.exceedlms.com/student/path/29785-google-ads-apps-certification>), Shopping (<https://skillshop.exceedlms.com/student/path/18287-shopping-ads-certification>))
- **A Beginner’s Guide to Using Google Ads** (<https://blog.hootsuite.com/google-ads/>)
- **The Ultimate Guide to Google Ads** (<https://blog.hubspot.com/marketing/google-adwords-ppc>)
- **How Do Keyword Match Types Work in Google?** (<https://www.wordstream.com/keyword-match-types>)
- **How To Write Text Ads For Google That Get Clicked On By Your Prospects** (<https://www.adhocmarketing.com/blog/how-to-write-expanded-text-ads-on-google-that-get-more-clicks-than-your-competition>)
- **Get Started with Microsoft Advertising** (<https://help.ads.microsoft.com/apex/index/3/en/56873>) (*formerly Bing Ads*)
- **The Essential Guide to Digital Marketing with Facebook & Instagram** (<https://www.facebook.com/business/learn/series/guide-to-digital-marketing-using-facebook>)
- **Complete Guide on LinkedIn Advertising** (<https://expandi.io/blog/linkedin-advertising/>)
- **The Complete LinkedIn Advertising Cheatsheet** (<https://www.wordstream.com/blog/ws/2019/03/05/linkedin-advertising>)

Media Attributions

- Campaigns by Rochelle Grayson is licensed under a CC BY 4.0 licence.
- Pizza display ad by Rochelle Grayson is licensed under a CC BY 4.0 licence.
- Screenshot of Google search of pizza shopping ads © Google LLC and this book is not endorsed by or affiliated with Google in any way. Used with permission

(<https://about.google/brand-resource-center/guidance/media/>).

- Ad campaign structure by Rochelle Grayson is licensed under a CC BY 4.0 licence.
- Type of keyword matches by Rochelle Grayson is licensed under a CC BY 4.0 licence.
- Ad rank by Rochelle Grayson is licensed under a CC BY 4.0 licence.

13.

Social Media Marketing

Learning Objectives

By the end of this chapter, you should be able to:

- **Describe** why social media is important
- **Develop** a social media strategy and plan
- **Explain** the 6-Step Social Media Marketing Framework
- **Differentiate** between the various types of social media networks



Why Use Social Media?

Many people think social media is digital marketing. While social media marketing can take up a lot of marketers' attention, it only represents one component of a digital marketing strategy. Before diving into specific strategies and tactics of social media, let's review why social media is important to digital marketing. There are many advantages to using social media for professional purposes and to promote your organization, products, and services. Here are several areas where social media shines:

- **Connecting with New Audiences**

Billions of people worldwide use social networks on a daily basis. Therefore, it is important for organizations to be present where these online conversations and discussions are happening. For example, ~60% of Instagram users said they find new products on the platform, making it worthwhile to be there.

- **Building Relationships**

Now, more than ever, it's critical for organizations to have a unique voice and engage with customers on a human level. Social media provides an easy way to do this, allowing marketers to create a brand personality as well as a voice that communicates brand values and engages the community.

- **Increasing Website Traffic**

If your community likes your social media content, they may seek out more information about your products and services on your website, which will result in more website traffic and potentially more sales.

- **Distributing Targeted Messaging**

It's very easy to distribute ads on social platforms. Moreover, marketers can narrowly target their ads and messaging to match the specific needs and interests of their target audiences. Studies have shown that customers react better when advertisements are customized to their specific needs and this strategy can result in increased interactions and interest.

- **Conducting Market Research**

Social media isn't just great for interacting with your community, marketers can also use it to stay on top of what their competitors are doing. By listening to the social media conversations, marketers can glean what is working well (or not) for their competitors. They can then build these insights into their social media marketing strategies and tactics.

- **Sharing Expertise**

Social media sites provide many opportunities for organizations to both hear about and differentiate themselves from their competitors. Organizations can do this by showcasing themselves as industry leaders via engaging, insightful, and relevant content, e.g., by sharing creative visual content on Instagram, composing thoughtful blog posts on LinkedIn, or revealing a fresh viewpoint in Twitter.

- **Managing Reputation**

Reputation is everything, and social media sites provide a direct way to interact with customers and to resolve problems swiftly. For example, marketers can develop unique hashtags that can highlight concerns or interests and ensure that these issues are seen and addressed quickly by the right people. Social media sites can also be leveraged to share positive reviews, testimonials, and customer feedback.

- **Evaluating Analytics and Insights**

Most social media platforms have their own analytics tools, which allow you to keep track of what your community is interested in, who is engaged, and what activities and content are best performing. This data can help determine which content to promote and how to appropriately modify any advertising or marketing activities.

Now that we understand why social media is a key component of a digital marketing strategy, let's look at how marketers can successfully implement a social media plan.

A 6-Step Social Media Marketing Framework



This 6-Step Social Media Marketing Framework aims to ensure your social media strategy and activities are optimized to convert prospective customers into satisfied, paying customers and brand advocates. As you learn more about digital marketing, you will be presented with a variety of different frameworks. Being able to understand what is similar and what is different will be important. Ultimately, you may come up with your own framework, which will likely be a combination of several frameworks. However, using a framework gives you the best chance of implementing the right strategy for your circumstances. This framework will also provide alignment between your chosen strategy and your activities. Let's take a closer look at each of the following steps:

Step 1: Listen and Learn

Social media allows marketers to listen to what their target audiences are saying and doing. Without any prompting, marketers can now listen to what their customers are saying about their needs, wants, and desires. We no longer have to guess!

Listening is the first place for marketers to start when developing a social media strategy. Listening is key to understanding your target audience's perceptions related to:

- **Your brand, products, and services**
Since social media conversations are happening in real-time and directly from your community, you no longer need to guess about why people are behaving a certain way; they will tell you.
- **Your competitors' brands, products, or services**
If you find out what your competitors are good or bad at, you can position your organization to meet some of those customer needs better. Or, perhaps, you can identify new products and services you can offer.
- **General topics and trends**
If you can find out what's popular, you may be able to take advantage of emerging opportunities and generate new revenue streams.

Listening and learning from your target audiences is the first important step when implementing a social media strategy.

Step 2: Define Goals, Objectives, and Target Audiences

With a well-defined scope, which includes specific goals, objectives, and target audiences, it is possible to achieve positive outcomes, since you know what you are aiming for. If you know what you want, you can put the steps in place to get there. Successful marketers and organizations know what they want to achieve, and a clear focus on goals and objectives is what ultimately guides all their actions.

Identifying goals, objectives, and target audiences is a critical step in getting buy-in from key decision makers, assigning resources (human, financial, and technological), and planning social media campaigns and ongoing activities. Everyone in an organization should work and plan towards achieving these goals and objectives so it is important to get this step right.

Ideally, digital marketers should plan to complete this step collaboratively because some of the required information might exist in different areas of the organization. This information should include:

- Lessons learned from the listening step of the framework: what the community is saying about your products, your competitors, and trends
- Customer personas and customer journey maps developed
- Competitive intelligence learned in the listening step or through other research / studies
- Knowledge about the preferences of the online communities

- Lessons learned from previous social media campaigns/ongoing activities
- Organizational goals and objectives

If organizations don't properly align their goals, objectives, and strategies, they will waste money, time, resources, and effort.

For a startup, this could be quite costly and ultimately, result in going out of business. For an established business, this may result in losing ground to the competition, missing an important market opportunity, losing key people who do not feel supported, falling stock prices, or even going out of business. It can also lead to companies becoming reactive and developing an organizational culture of crisis management where you are constantly fighting fires instead of planning and being proactive.

Quick Goal Alignment Quiz

If Marketing Director, Sam, has been told by senior management that the organizational goals for this year are to increase sales of product X, which of the following goals are relevant for the social media marketing team? (Select all that apply.)

- Increase product awareness of product X on Facebook
- Decrease product X customer service costs by using Twitter
- Increase traffic to product X website
- Increase sales of product X on Twitter

Step 3: Choose Channels

While setting goals and objectives is a critical part of planning, how you achieve them has more to do with your implementation plan. Therefore, in this step we will focus on achieving those goals and objectives by selecting the appropriate digital marketing channels and platforms.

Since there are so many social media options, marketers often struggle in selecting the appropriate social media platform to use. Instead of trying to pick specific social media sites, organizations should focus on the type of social media marketing that will work best for their target audiences and build a presence on 2 – 3 platforms that support those activities and cater to those audiences.

Types of Social Media

The following are the most prominent types of social media networks / platforms. In each of the sections below, you can read the category description, the pros and cons, and examples of sites that fall into that category:

Social Networks

By far the most popular, social networks connect people to each other and to organizations. Organizations can use these networks to promote products, services, and content. They can advertise to diverse audiences and work with influencers to reach target audiences. In addition, marketers can listen

in on public conversations about their organization, competitors, and industry, and use those insights to improve customer experiences and increase brand awareness.

Pros:

- Large, diverse audiences, i.e., most people are active on one of these platforms
- Lots of activity
- Integrated into many marketing automation tools and services

Cons:

- Difficult to be seen / heard due to the volume of content and activity
- Algorithms often promote individual posts over business posts, which means organizations may need to pay for exposure

Examples of social networking platforms*:

- Facebook (<https://facebook.com/>)
- Twitter (<https://twitter.com/>)
- Instagram (<https://instagram.com/>)
- LinkedIn (<https://linkedin.com/>)

**Please note that some sites may be listed in multiple categories.*

Photo Sharing Networks

Visual storytelling has become a staple on social media. As a result, image sharing networks are quite popular and should be part of most social media strategies. These social media sites allow individuals to share images and visual content. They provide a platform to spark conversations, inspire ideas, and promote products, contests, and experiences that get people talking about brands.

Pros:

- Large audiences
- Lots of activity
- Well suited for products or experiences that can be presented in a visual form
- Good channels to promote brand values and build brand awareness

Cons:

- Visual content may not be appropriate for all organizational offerings
- Requires visual storytelling expertise
- Some features may only be available on mobile devices

Examples of image-sharing networks:

- Instagram (<https://instagram.com/>)
- Pinterest (<https://pinterest.com/>)
- Behance (<https://www.behance.net/>)
- Flickr (<https://flickr.com/>)
- Imgur (<https://imgur.com/>)
- Sina Weibo (<https://weibo.com/>)

Video Sharing Networks

Video-sharing networks can be split into two main categories: short-form and long-form video.

Short-form Video

Short-form video typically includes videos that are less than two minutes long. The most popular platforms are TikTok & Instagram Reels.

Pros:

- Great for building brand awareness, sharing quick tips, and repurposing other content into shorter or more interactive versions – like long-form video or a series of images

Cons:

- Limited time to communicate messages
- Requires strong storytelling expertise, as well as video production and editing skills

Examples of short-form video networks:

- TikTok (<https://www.tiktok.com/en/>)
- Instagram Reels (<https://instagram.com/>)
- YouTube Shorts (<https://youtube.com/>)
- Triller (<https://triller.co/>)
- Snapchat Spotlight (<https://www.snapchat.com/>)
- Pinterest Story Pins (<https://pinterest.com/>)

Long-form Video

Long-form video refers to videos longer than two minutes. YouTube and Vimeo are the leading platforms. YouTube has better SEO, but Vimeo has a stronger community and no pre-roll ads.

Pros:

- Great for organizations looking to teach in-depth courses, share long journeys, or walk through a process.
- More time to build a narrative
- Video analytics to assess what is resonating

Cons:

- Audience may not watch long-form content to the end
- Content creation usually is more costly
- Content can become stale and outdated
- SEO is more complicated

Examples of long-form video networks:

- YouTube (<https://youtube.com/>)
- Vimeo (<https://vimeo.com/>)
- Twitch (<https://www.twitch.tv/>)
- Instagram TV (<https://instagram.com/>)
- Facebook Watch (<https://facebook.com/>)

Livestreaming Networks

Following short-form video, one of the fastest growing types of social media networks is livestreaming. Livestreaming delivers live video content that typically interacts with a live audience / viewer. Livestreaming is available on almost all popular social media platforms.

Pros:

- Immediacy of audience interactions, feedback, engagement, etc.
- Ability to share experiences / events in real-time

Cons:

- Requires a consistent and high-quality internet connection, as well as live video streaming production capabilities, e.g., cameras, lighting, microphones, etc.

Examples of livestreaming networks:

- Twitch (<https://www.twitch.tv/>)
- Instagram Live (<https://instagram.com/>)
- TikTok (<https://www.tiktok.com/en/>)
- YouTube (<https://youtube.com/>)

- Facebook Live (<https://facebook.com/>)
- Pinterest TV (<https://pinterest.com/>)

Interactive Media Networks

Interactive Media Networks allow their users to connect, create and share content. Quite often, they offer a variety of unique interactive and highly experimental features such as AR/VR filters, musical overlays, and interactive games. These networks tend to be most popular among Gen-Z and Millennials.

Pros:

- Platforms are very creative and experimental.
- The audiences skew younger and are a good market for brands targeting Gen-Z and Millennials
- Stories can be used to provide a behind-the-scenes look at your brand or the process of bringing a new product / service to market

Cons:

- Potentially expensive and time-consuming content creation
- Some features may only be available on mobile devices
- Promotion *within* these networks can be challenging, which requires promoting via your website or other social platforms

Examples of interactive media networks:

- TikTok (<https://www.tiktok.com/en/>)
- Snapchat (<https://snapchat.com/>)

Community Forums

Community forums encourage people to answer questions posed by the community and to share knowledge, news, and ideas. These websites discourage direct advertising and generally, do not have brand pages. Answering questions correctly and honestly in these forums can increase a member's credibility and that credibility or trust could lead to increased website visits and sales.

Pros:

- Great resource for conducting market research and generating leads for your products or brand. This can help build more focused marketing campaigns.
- Ability to give community members early access to offers, try out freebies, and gather feedback.
- Thought leadership and expertise can be rewarded through upvoting of content

Cons:

- Must adhere to the rules of engagement within the community
- Distrustful of organizations
- Potential for groupthink, i.e., everyone in the community thinks the same way and new ideas / perspectives are not considered or accepted
- To build meaningful relationships, community management can be time-consuming

Examples of community forums:

- Reddit (<https://www.reddit.com/>)
- Quora (<https://www.quora.com/>)
- Clubhouse (<https://www.joinclubhouse.com/>)
- Discord (<https://discord.com/>)
- Slack (<https://slack.com/>)
- Facebook Groups (<https://facebook.com/>)

Blogging & Publishing Networks

These networks provide a place to publish written, long-form content and can be an important component of your **content marketing strategy** (<https://pressbooks.bccampus.ca/foundationsindigitalmarketing/chapter/content-marketing/>). Consider writing about how to use your products in creative ways, or post news about your industry to drive more traffic to your website or online accounts.

Pros:

- By publishing on a shared network (as opposed to on your organization's website only), marketers can attract readers from the entire pool of people who visit that network looking for interesting content.
- Can create backlinks as part of your link building strategy

Cons:

- Requires writing skills and producing long-form, written content on a regular basis.
- Must adhere to the network's publishing guidelines, which might limit the range of writing topics

Examples of blogging and publishing networks:

- Medium (<https://medium.com/>)
- WordPress (<https://wordpress.com/>)
- Tumblr (<https://www.tumblr.com/>)

- Facebook (<https://facebook.com/>)
- LinkedIn (<https://linkedin.com/>)

Podcast / Social Audio Networks

Podcast Networks

More and more organizations are taking advantage of the opportunity to market their products and services using audio. Audio podcasts and social audio networks allow listeners to gain knowledge, share ideas, and/or join discussions in an audio format.

For many listeners, these audio experiences are easier to consume. People can listen wherever they are, including while commuting, offline (if downloaded), or simply as background noise during daily activities. Podcasting is less restrictive than watching a video or even scrolling through a feed.

Pros:

- High-quality audio podcasts are more affordable to produce than high-quality videos
- Asynchronous and multi-tasking listening possibilities

Cons:

- When multi-tasking, listeners may not fully hear what is being discussed
- Requires a robust content marketing strategy and content calendar to maintain

Examples of podcasting networks:

- Spotify (<https://open.spotify.com/genre/podcasts-page>)
- Apple Podcasts (<https://www.apple.com/ca/apple-podcasts/>)
- Google Podcasts (<https://podcasts.google.com/>)
- Pandora (<https://www.pandora.com/browse/podcasts>)
- TuneIn (<https://tunein.com/podcasts/>)
- Stitcher (<https://www.stitcher.com/>)

Social Audio Networks

Social audio is yet another social media network type that offers live discussions with the audience rather than pre-recorded audio conversations. Like livestreaming, these networks are great for connecting with an audience in real-time and getting immediate feedback.

Pros:

- Marketers can host their own rooms which allows them to share knowledge and establish themselves as thought / industry leaders
- Many of the same benefits as livestreaming with lower production costs

Cons:

- Listeners may be distracted
- Listeners need to listen in real-time or they might miss the discussion (if not recorded)

Examples of social audio networks:

- Facebook Live Audio Rooms (<https://facebook.com/>)
- Spotify Greenroom (<https://www.spotify.com/us/greenroom/>)
- Twitter Spaces (<https://help.twitter.com/en/using-twitter/spaces>)
- Clubhouse (<https://www.joinclubhouse.com/>)

Messaging Apps

Messaging apps have evolved to be more than just a simple way to share text messages. With features for calling, creating groups, broadcasting messages to multiple users, exchanging money, and the option of creating chatbots, messaging apps can help your organization in many ways. For example, many small businesses are using Facebook Messenger chatbots to interact, support, provide suggestions, and share news with their customers.

Pros:

- Built into the social networks that individuals already use
- Technology infrastructure managed by a third-party
- Ability to resolve customer complaints, concerns, or issues in a more private channel
- Quick, direct communication channel to respond to questions

Cons:

- Dependent on third parties, e.g., when Facebook and WhatsApp went offline, these organizations couldn't connect with their customers
- Managing yet another customer communication channel

Examples of messaging apps:

- Facebook Messenger (<https://www.facebook.com/messenger/>)
- WhatsApp (<https://www.whatsapp.com/>)
- Telegram (<https://telegram.org/>)
- Instagram (<https://instagram.com/>)
- Viber (<https://www.viber.com/>)
- WeChat (<https://www.wechat.com/>)
- Line (<https://line.me/>)

For more ideas on how to use these, check out this article, [The Best Messaging Apps for Customer Service \(https://www.revechat.com/blog/messaging-apps-for-customer-service/\)](https://www.revechat.com/blog/messaging-apps-for-customer-service/).

Bookmarking & Content Curation Networks

Bookmarking and content curation networks are platforms where users discover, save, and share a variety of ideas, articles, posts, and other content for later use. The purpose of these websites is to discover new content based on shared interests and to discuss trends. By creating and curating content that is current and relevant to your industry, marketers can use these networks to direct people to their website and engage with the community by sharing content to bookmark.

Pros:

- Great for sparking new ideas, as well as highlighting news, hot topics and trends
- Share knowledge and establish your organization as a thought / industry leader and expert

Cons:

- Requires consistent content creation, which could be time-consuming
- Content curation can also be time-consuming

Examples of bookmarking networks:

- Pinterest (<https://pinterest.com/>)
- Flipboard (<https://flipboard.com/>)
- Tumblr (<https://www.tumblr.com/>)
- Dribbble (<https://dribbble.com/>)

Review Networks

Review networks allow people to find, review, and share information about brands and their products and services. These types of networks reveal the customer experience. Good or bad, reviews help identify what is working and what is not and provide an opportunity for organizations to make improvements and/or resolve issues. How an organization responds to a review will often showcase a brand's values and how they handle customer feedback. When reviews are managed well, organizations can build trust and loyalty with their community, which can bring positive social proof to the organization and its claims.

Pros:

- Positive reviews can increase traffic and sales because they reflect the (unfiltered) opinions of customers
- Ability to turn a negative experience into a positive one quickly

Cons:

- Managing reviews can be time-consuming, especially since you want to respond as quickly as possible (for both good and bad reviews)
- Reviews are highly subjective and based on the reviewer's expectations

Examples of review networks:

- Yelp (<https://www.yelp.com/>)
- Google My Business (<https://www.google.com/business/>)
- Glassdoor (<https://www.glassdoor.ca/index.htm>)
- TripAdvisor (<https://www.tripadvisor.ca/>)
- Amazon (<https://amazon.ca/>)

Social Shopping Networks

Social shopping networks create a community of individuals who share similar interests and opinions, and influence each other's purchasing decisions. These networks help buyers spot trends, share great finds, make purchases, and follow their favorite brands. They focus on e-commerce, and the social element makes it engaging and entertaining. These social shopping sites are ideal for building awareness about your brand and selling to a wider audience.

Many social networks now also include social shopping elements. For example, Facebook Marketplace allows people to sell items to their friends, followers, and other buyers nearby, making it much easier to sell used products.

Pros:

- Purchase decisions are largely driven by the community, which means organizations should seed conversations with the appropriate benefits
- Strong social proof
- Word-of-mouth can spread quickly

Cons:

- Negative feedback can spread quickly
- First impressions carry more weight
- Tend to be more niche markets so the market upside may be limited

Examples of social shopping networks:

- Etsy (<https://www.etsy.com/ca/>)
- Faveable (<https://faveable.com/>)
- Instagram Checkout (<https://instagram.com/>)
- Poshmark (<https://poshmark.ca/>)

- Facebook Marketplace (<https://facebook.com/>)

Interest-Based Networks

In contrast to those social networks that cover a wide range of topics, interest-based networks focus solely on a single area of interest, e.g., books, cycling, pregnancy, or home design. For organizations looking to connect with niche target audiences, these networks can deliver high quality relationships, focused market insights, and critical market trends.

Pros:

- Strong niche-based community
- Great for brand awareness and word-of-mouth referrals
- Highly focused messaging and communications may require less time

Cons:

- Niche market, so insights might only apply within that community and not be transferable
- Negative feedback can spread quickly, and organizations may not be given a second chance

Examples of interest-based networks:

- Goodreads (<https://www.goodreads.com/>) (books)
- Strava (<https://www.strava.com/>) (cycling and running)
- Peanut (<https://www.peanut-app.io/>) (pregnancy)
- Houzz (<https://www.houzz.com/>) (home design)

For more examples, check this list of social network apps for interest-based communities (<https://unblind.com/blog/best-social-network-apps-with-interest-based-communities>).

Sharing Economy Networks

Like interest-based networks, sharing economy networks also cater to specific niche audiences. These networks are built around the sharing of goods and services, with the goal of improving efficiency, sustainability, and community. Essentially, by choosing to share items such as vehicles, recreation equipment, or tools, there is less strain put on the market to produce goods since purchases are replaced by borrowing and lending across the community. For example, a sharing economy site focused on pets could help a user find someone willing to take care of their dog while on vacation. It would be less costly than a kennel and more comfortable for the pet. If your company sold pet toys or food, you could potentially gain new customers by advertising or offering product or service promotions for users to try.

Pros:

- Well-connected and highly targeted, niche communities
- Great for brand awareness and word-of-mouth referrals

- Focused messaging and communications may require less time

Cons:

- Niche market, so insights might only apply within that community and not be transferable
- Negative feedback can spread quickly, and organizations may not be given a second chance

Examples of sharing economy networks:

- Airbnb (<https://www.airbnb.ca/>)
- Lending Club (<https://www.lendingclub.com/>)
- CouchSurfing (<https://www.couchsurfing.com/>)
- Eatwith (<https://www.eatwith.com/>)
- Fiverr (<https://www.fiverr.com/>)
- TaskRabbit (<https://www.taskrabbit.com/>)

Anonymous Social Networks

Anonymous social networks let you post anonymously. Since these sites allow users to post anonymously, there is no accountability and these networks can easily become sites for cyberbullying, to vent, gossip, or snoop – none of which help a business or brand.

Pros:

- Unfiltered feedback / opinions (true or perceived)
- Insights, facts, and opinions may be shared that otherwise would remain hidden

Cons:

- Can become quite toxic and negative and organizations may not fair well

Examples of anonymous social networks:

- 4chan (<https://www.4chan.org/>)
- Whisper (<http://whisper.sh/>)

Reflection

Now that you have reviewed the different types of social media networks and the pros and cons of each:

- Which ones best meet the needs and activities of your customer personas / target audiences?
- Which ones best suit your brand?

- How can you leverage these channels to achieve your organizational goal and objectives?

Step 4: Create Content

After choosing your channels, the next step in our 6-Step Social Media Marketing Framework is content creation. After selecting the appropriate social media networks, marketers can focus on creating the content that works best for that specific channel and the target audience. Questions to consider include:

- What do you want your community to do?
- What does your target audience find most engaging?

This is not about creating content for the sake of it. Think strategically about what you are trying to achieve, which should be clear after the listening stage, and then deliver content based on that. And, remember to follow the content strategy, content calendar, and lead magnet recommendations discussed in the **Content Marketing** chapter.

Step 5: Engage the Community

Listening is just one side of the equation. Once you have listened to your community, you will need to go out and build positive relationships that last. This is done by engaging your customers with content they find valuable. However, simply pushing out content and hoping that your community will like, comment, and share the content is somewhat unrealistic and unproductive. To get the best out of content and to develop meaningful relationships and trust, it is necessary to engage with your community.

Usually, the key to successful engagement is conversation. Engagement can take on other forms such as sharing, liking and posting and to a certain extent, your community will determine which form is most suitable. However, conversations lie at the heart of social media. It is a central facet: people want to talk to each other. This then leads to the following questions about conversations:

- **What is a conversation?**
Simply defined, it is a dialogue between at least two people, possibly more.
- **Why are conversations important?**
Conversations communicate who we are, what our needs are, and what we feel.
- **How do conversations impact business?**
Conversations in business are not new; commerce has revolved around conversations for millennia. The rules that applied to good conversation back then also apply to today's social media business conversations. In 44 BC, Cicero put forward the following rules for good conversation:

1. Speak clearly.
2. Speak easily, but not too much, give others their turn.
3. Do not interrupt.
4. Be courteous.
5. Deal seriously with serious matters, gracefully with lighter ones.
6. Never criticize people behind their backs.
7. Stick to subjects of general interest.
8. Do not talk about yourself.
9. Never lose your temper.

All these rules still apply to maintaining good conversations in social media. For example, although you or your organization may want to talk about your brand, it is best to avoid direct marketing and sales via social media as part of a conversation or dialogue. If it makes sense to bring it up as part of a conversation, feel free. But, remember, no hard selling!

In addition, to Cicero's rules for conversation, there are three more pertinent social media conversation guidelines to consider:

1. Get to know who you are talking to. (*Remember your customer personas?*)
2. Listening is more important than talking.
3. If you're going to be talking have something important to say.

Again, the secret to successful conversation and engagement will be to listen to your community and find out what it is they like to talk about and in what manner. Knowing this, you can have more impact when it is time to say something since you already speak their language and are part of the community. As part of your content strategy, write down what tone of conversation is relevant to your community. For example, do you want to be light and informal or are you required to be more serious and formal? Develop your conversational style according to your community.

Engagement Pyramid

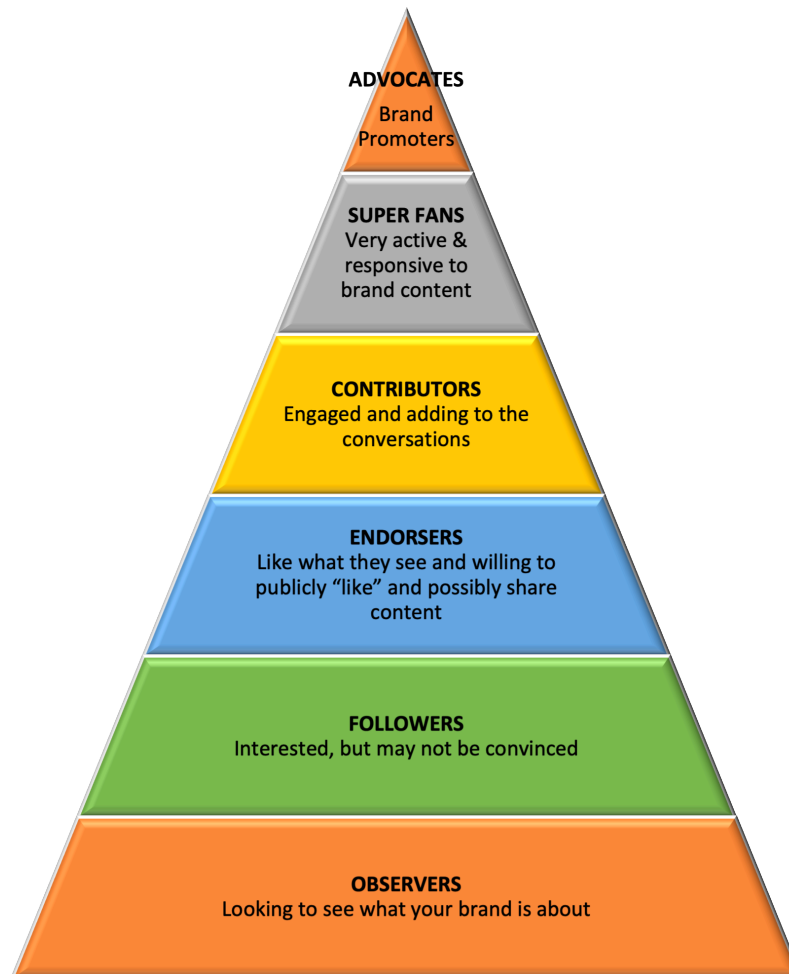

[Image description]

Marketers should also be aware of the engagement pyramid and the passive majority. Not everyone on social media will engage. According to the engagement pyramid, the vast majority of a community will be passive. This means that those individuals doing the talking represent a small percentage of your target audience. The digital marketing team needs to be aware of this as it will affect responses to your content as well as engagement around your posts.

- Passive behaviours would represent the majority of people who see, view, and even read, watch, or listen to content but choose not to comment or share it. In fact, in many of the larger social networks, a good engagement level (Facebook uses the term ‘people talking about this’) is usually anything above 10%. Here engagement refers to liking, sharing, and commenting on posts.
- Active behaviours refer to the types of action most digital marketers seek, e.g., liking, commenting, and sharing. This primarily refers to the endorsers, contributors, and super fans in the pyramid. Advocates are the ones who take engagement to another level. They are the ones creating their own posts about your brand and promoting your brand to their own social networks.

The key takeaway here is that 10% may be a rough guide as to the level of engagement to expect for your content. Clearly, this will differ depending on industry and how inherently social your product is. For example, a social media post about acne products might not get too much sharing.

Also make sure that you allow the most engaged members of your target audience to flourish. Offer them rewards and incentives for their hard work. Tell them you appreciate their efforts and give them something back in return. This could even drive user-generated content and/or competitions. Take, for example, a Pinterest competition created by Peugeot cars. In this competition, Peugeot posted pictures of cars to their Pinterest board showing tiny sections of cars. Followers then had to go to Peugeot's Facebook page to find out which car the picture was taken from for a chance to win something.

As well as conversations, another key goal of social media is virality. Most organizations want their content to go viral. Many marketers have studied why a piece of social media content goes viral and there does not seem to be one definitive answer. However, there are some commonalities. Apparently, most viral content pieces tend to be in one or more of the following four categories:

- Very helpful / practical
- Unique / amazing / spectacular
- Funny
- Controversial

Viral content can be a combination of any of the above categories but generally at least one is involved. However, from a business perspective, before trying to make engaging content, determine what is appropriate for your target audience. For example, while edgy and causing more buzz and reach, does a controversial video fit with your community's sensibilities/personalities, your content strategy, and your overall brand image and personality?

During the engagement stage, marketers need to be aware of how to build and foster trust in their online relationships. To tap into virality and achieve massive reach, marketers will need to understand which content types are most likely to truly engage their target audiences.

Step 6: Measure, Analyze, and Optimize

Measuring is crucial to social media's impact on an organization. Without measurement, marketers have no yardstick and no means of understanding whether their activities are succeeding or not. Through analytics, surveys, and content analysis, it is now possible to measure the success of your social media activities. Collate and collect all your data so that you can analyze how things went during the current cycle of the framework. In addition to your social media analytics and insights, you will potentially need other information, such as:

- online web analytics
- a timeline of important events or activities that may have affected the organization in the online, social, and offline worlds
- financial data regarding sales

Once you have all the data, assess the success of your social media marketing campaigns and ongoing activities by examining how it all fits together. Review any lessons learned and optimize your strategy for the next iteration of the cycle. Once again, start with a listening phase to find out if there is anything new and/or what's changed for your target audiences. For example, if you found out that one product was less popular in terms of engagement and sharing, you may want to focus your attention on monitoring keywords associated with that product in the next listening phase. Measure, analyze, and optimize your activities so that you can properly evaluate what worked and what didn't. This is crucial for future planning of your social media activities. In the **Digital Marketing Analytics** chapter, we will dive into specific metrics and analytics more.

Key Takeaways

The six steps in the social media marketing framework are:

1. Listen to and learn from the community
2. Define your goals, objectives, and target audiences
3. Choose the appropriate social media channels
4. Create content that your target audiences will find compelling
5. Engage with the community via meaningful conversations
6. Measure, analyze, and optimize your results

And, there are many types of social media networks, each with their own pros and cons:

- Social Networks
- Photo Sharing Networks
- Video Sharing Networks
- Livestreaming Networks
- Interactive Media Networks
- Community Forums
- Blogging & Publishing Networks
- Podcast / Social Audio Networks
- Messaging Apps
- Bookmarking & Content Curation Networks
- Review Networks
- Social Shopping Networks
- Interest-Based Networks
- Sharing Economy Networks
- Anonymous Social Networks

Social Media Marketing – Additional Resources

Here are several articles and free industry certifications that provide more social media marketing details:

- Social Media Marketing Resources for Beginners (<https://blog.hubspot.com/marketing/social-media-marketing-resources>) (blogs, podcasts, books, etc.)
- SEMrush Social Media Marketing Fundamentals Course with Neal Schaffer (<https://www.semrush.com/academy/courses/smm-fundamentals-course-with-neal-schaffer>) (4 hrs.)
- Hubspot Social Media Marketing Certification (<https://academy.hubspot.com/courses/social-media>) (5.5 hrs.)
- Twitter Flight School – Digital & Social (<https://www.twitterflightschool.com/student/path/578806-digital-social>) (5 hrs.)
- Hubspot Inbound Marketing Certification (<https://academy.hubspot.com/courses/inbound-marketing>) (4 hrs.)

Media Attributions

- Word cloud (<https://www.maxpixel.net/Internet-Social-Media-Advertising-Content-Marketing-1573711>) from MaxPixel (<https://www.maxpixel.net/>) is licensed under a CC0 Public Domain.
- 6-step social media marketing framework by Rochelle Grayson is licensed under a CC BY 4.0 licence.
- Engagement pyramid by Rochelle Grayson is licensed under a CC BY 4.0 licence.

Image Descriptions

Engagement Pyramid

A pyramid-shape diagram demonstrating the engagement level of social media users with the brand. From top to bottom:

- Advocates – brand promoters
- Super fans – very active & responsive to brand content
- Contributors – engaged and adding to the conversations
- Endorsers – like what they see and willing to publicly “like” and possibly share content
- Followers – interested, but may not be convinced
- Observers – looking to see what your brand is about

[Return to Engagement Pyramid]

14.

Mobile Marketing

Learning Objectives

By the end of this chapter, you should be able to:

- **Explain** how to develop a mobile marketing strategy
- **Describe** several mobile-specific content options
- **Identify** key factors that are unique in mobile experiences
- **Determine** unique opportunities for targeting mobile users

Mobile Marketing Strategy

Mobile marketing refers to those activities that use and leverage mobile devices, e.g., tablets, phones, or watches, to connect with target audiences and to promote a brand's products or services. Before diving into a variety of mobile marketing tactics and activities, let's first develop a mobile marketing strategy. Your mobile marketing strategy is a subset of your overarching digital marketing strategy. This means your mobile marketing strategies should support and align with both your marketing and digital marketing goals and objectives. That said, since so many people are now accessing the internet using mobile devices, i.e., smartphones and tablets, a mobile marketing strategy may represent the core digital marketing strategy for a particular organization. This strategic decision will largely be driven by the **target audiences** and their mobile behaviours.

To begin developing your mobile marketing strategy, you will want to ask the following key questions:

- **Where is our mobile strategy today?**
Ask yourself what mobile experiences have we already created, e.g., mobile-friendly website, mobile app, mobile marketing campaigns / outreach, email marketing campaigns, etc.? In essence, you want to take inventory of your mobile activities and then compare them to your competition. This approach is often referred to as situational analysis. **Situational analysis** is the process of critically evaluating the internal and external conditions that affect your organization.¹ Some common business frameworks used for this activity are SWOT Analysis, PESTLE Analysis, Porter's Five Forces, 5 C Analysis, and VRIO Analysis.
- **Where do we want our mobile strategy to be in the future?**

1. The Easy Guide to Performing an Effective Situation Analysis (<https://creately.com/blog/diagrams/what-is-a-situation-analysis/>)

When answering this question, think about what the *ideal* mobile customer experience should be. This experience should add significant value to your mobile audiences such that they are willing to give you their time and/or money for that “wow” experience.

- **How do we get there?**

In this final step, explore ways to deliver those mobile experiences that provide a sustainable competitive advantage. And as part of these considerations, identify the various mobile channels you want to use, e.g., a mobile website, mobile app, social media optimized for mobile, text messaging, etc.

Mobile Advertising Content Channels

Like other areas of digital marketing, content is a core element of mobile marketing. To ensure that your content is viewed, you need to make sure your content is optimized for a mobile experience. When reviewing your mobile content, think about the following areas:

- **Website**

If your website is not mobile-friendly, not only will mobile visitors leave quickly, but your SEO will also suffer.

- **Email**

Many marketers use email to promote products, news, and developments with their target audiences. Many readers will open these emails on their mobile devices. So, make sure the email service you are using offers mobile-optimized versions of your email messages.

- **Mobile App**

Organizing, properly presenting, and prioritizing your mobile app content is crucial in fostering maximum engagement and use.

- **Social Media**

According to Statcounter, 78% of smartphone users access social media on their mobile devices once per day.² So, mobile users are a dominant audience on social media. Since social media platforms often format and present their content differently, make sure your posts conform to the correct specifications and that they are also consistent with the way content is viewed and shared on mobile devices. This is one reason why platform-specific content is recommended, as opposed to reposting the exact same content across all your channels.

Now, let’s look at several specific, mobile-optimized content options:

2. Mobile Social Media Stats Worldwide (<https://gs.statcounter.com/social-media-stats/mobile/worldwide>)

Responsive Web Design

RESPONSIVE WEB DESIGNS ON DEVICES



designed by  freepik.com

Responsive web design is about creating websites and webpages that deliver an optimal customer experience regardless of screen size. A responsive website will automatically adjust the content for different screen sizes, e.g., a large desktop monitor, laptop, tablet (vertical or horizontal orientation), and mobile phones. As the screen size increases or decreases, webpage elements will automatically reshuffle, resize, hide, shrink, or enlarge to make them look good on all devices.

Most web building technologies, e.g., WordPress, Wix, Weebly, Squarespace, etc., have responsive web design built right into their platforms. Or in other cases, these transformations are likely to be coded into your webpages by developers in conjunction with the design or marketing teams. As a marketer, if you are building standalone landing pages and/or other webpages, do make sure that they are responsive by testing and viewing your webpages on a variety of screens. For example, this can clarify whether your call-to-action buttons are visible or not before scrolling. To see an example of how one might rearrange a webpage to be responsive, here's a great blog post by Kristina Kledzik of Moz, who walks through the fundamental processes to create responsive webpages.³

Or, give it a try with this responsive landing page exercise:

3. The SEO of Responsive Web Design (<https://moz.com/blog/seo-of-responsive-web-design>)

H5P: Responsive Landing Page

Remember our previous example of a Great Landing Page? Well, now it's your turn to take elements from this webpage and create a responsive, mobile version.

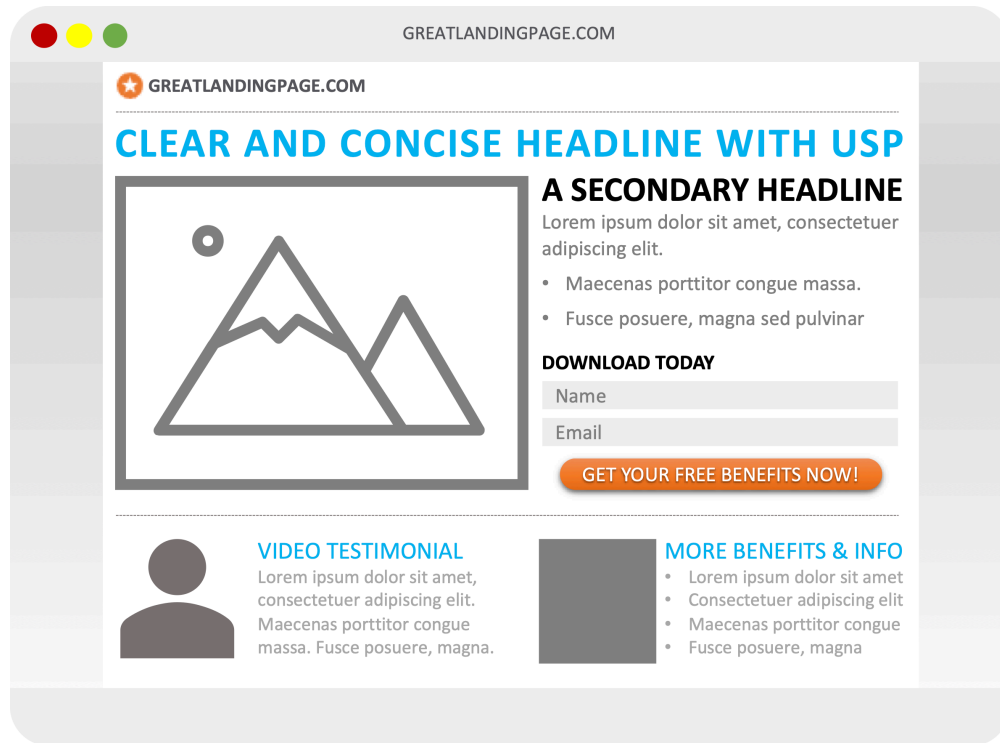

If you want to create a distinct customer experience, e.g., a customer portal, you might consider creating a completely separate mobile website. However, managing two different website experiences will be more expensive and will involve significantly more time, work, and maintenance.

Google's Accelerated Mobile Pages⁴ (AMPs)

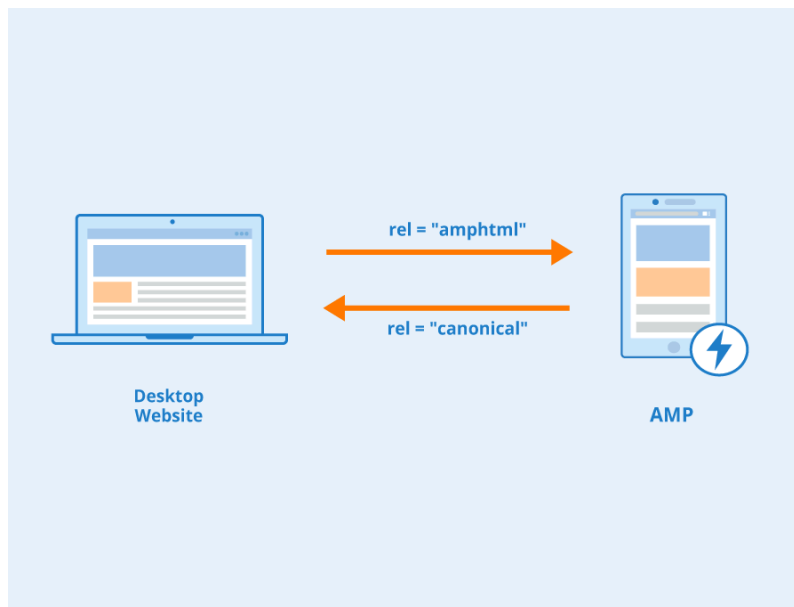

In early 2016, Google launched an open-source project and released the infrastructure for accelerated mobile pages. **Accelerated mobile pages (AMPs)** are essentially stripped-down versions of existing webpages that load significantly faster on mobile devices. AMP-enabled pages often remove elements like videos, ads, and animations and keep the most relevant content and images. For mobile users, not only can AMPs reduce the time to load, they can also reduce the amount of bandwidth required to view content, which on mobile devices is an important consideration. All of this sounds like a promising mobile experience.

However, to make AMPs work, marketers must use Google's infrastructure, which has three key components:

- **AMP HTML**
AMP HTML is a subset of regular HTML with a few AMP-specific tags, called AMP HTML components. These custom components, combined with the restrictive HTML, mean that AMP pages must be coded slightly differently than standard webpages. Note: you can have both AMP and non-AMP pages, but their underlying code will differ.
- **AMP JavaScript (JS)**
The AMP JS library handles resources and asynchronous loading. Unfortunately, third-party JavaScript is not allowed, which for some organizations may present an issue. For example, many social media sharing buttons use third-party javascript. So, these buttons would not be available on these pages.
- **AMP Cache**
To allow pages to load even faster, marketers can have their AMP-enabled pages cached (stored) and delivered from Google's content delivery network (CDN). Since Google's AMP CDN has cached versions of your pages, it can deliver those pages much more quickly.

While faster page loading times are compelling, there are several fundamental issues with AMPs

4. Google's Accelerated Mobile Pages (<https://developers.google.com/amp>)

- **Difficult to Implement**

While there is an easy-to-use WordPress plugin to create AMP-enabled pages, if your website is using a different web platform, creating valid AMP-enabled pages can be challenging and may require working with your website developers. This may also impact your ability to update and maintain these pages.

- **Lack of Analytics**

Unfortunately, you cannot use standard analytics tags because the AMP pages live on Google's servers. As a result, you may not get the analytics you need to assess your marketing activities, e.g., engagement, traffic, etc.

- **Decreased Ad Revenue**

While there are AMP-optimized ads, AMP-enabled pages usually reduce the number of ads shown, which can significantly impact your website's ad revenue.

- **Fewer Leads**

Unfortunately, AMP strips out lead magnet forms and downloadable assets, which reduces your ability to gather leads.

- **Less Social Sharing**

Many social sharing buttons use JavaScript. Since AMP does not allow third-party JavaScript, these buttons may not be shown, making it more difficult for viewers to easily share your content.

Given the above issues, AMP-enabled pages are being used less and less. AMP-enabled pages tend to work best for large media sites that have time-sensitive news / content that is primarily being viewed on mobile devices. As mentioned in our **SEO** chapter, there are many other ways to optimize your webpages and improve your SEO, while maintaining control of your webpages. So, you will need to decide if AMP-enabled pages best support your specific mobile marketing strategy or not.

Facebook Instant Articles⁵ (IA)

Instant Articles

Better for people. Better for publishers.

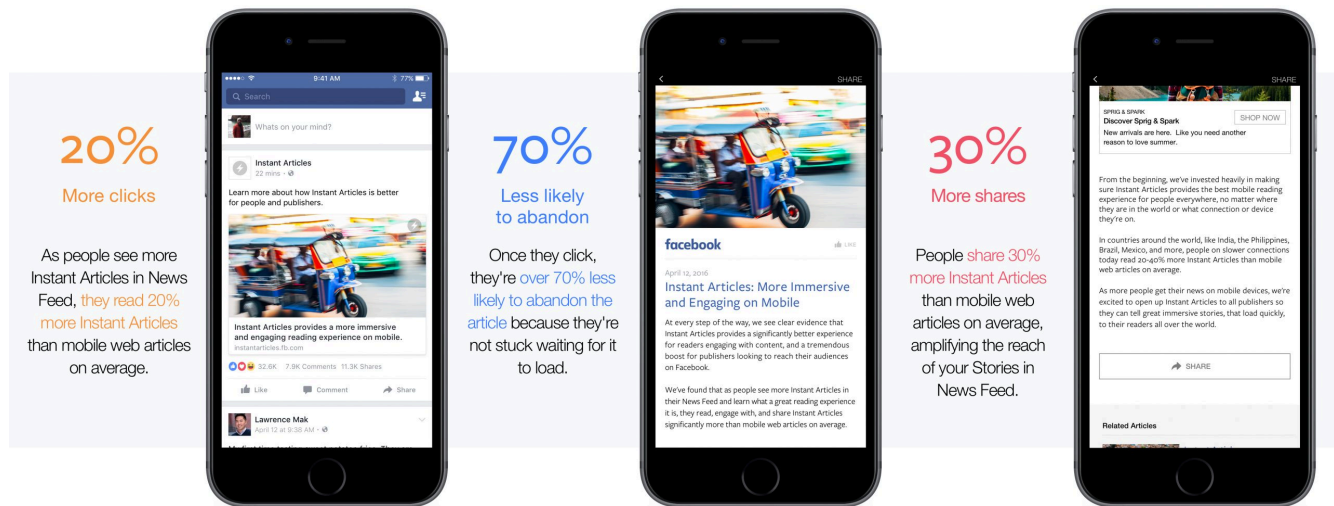

Instant Articles are Facebook's native publishing platform and are similar to Google's AMP. IAs are optimized for fast loading speeds and allow users to stay on the platform to read them.

To address many of the issues mentioned with AMP, Facebook Instant Articles have added several features over the years:

- **Circulation and Navigation Features**

The features allow marketers to insert buttons into their articles that link to other content or make it easy for viewers to share content, e.g., one button click to share via Facebook Messenger.

- **Subscriptions**

Understanding that many marketers wanted to drive subscriptions, Facebook added the ability to insert subscription buttons directly into articles, as well.

- **Call-to-Action Buttons**

Facebook IA offers the ability to include call-to-action buttons directly in articles. The analytics related to these clicks can be monitored via your Facebook Insights analytics.

- **Page-Like Option**

This feature allows viewers to like a Facebook page, i.e., the Facebook page managed by the publisher of the article, directly from within the article.

- **No Code Instant Articles Builder**

Facebook offers an Instant Articles builder that does not require coding. Simply download and install the builder and follow the guide to get started.⁶

5. Facebook Instant Articles (<https://www.facebook.com/formedia/tools/instant-articles>)

- **Third-Party Analytics Tracking**

Instant Articles integrate with many popular analytics tools, like Google Analytics, etc.⁷

While Facebook has done quite a bit to address many of the issues highlighted with AMP-enabled pages, there are still some drawbacks:

- **Reliance on Facebook**

While Facebook does have billions of active users, marketers are depending on Facebook, and their constantly changing algorithms, to reach their target audiences.

- **Limited Analytics Functionality**

While you can integrate third-party analytics tags, the integration method (iframes) does not capture behavioural analytics. Without these insights, you cannot track viewers' behaviours and your understanding of your audience's activities is not complete. Tracking viewer behaviour is a powerful way to define areas for improvement and to adjust your **content strategy** to achieve organizational goals and objectives.

- **Brand Identity Issues**

Even though your Instant Articles can be housed in your own content management system, all your content is converted to a single Facebook template / design. While there is a logo bar at the top and some colour and font choices, your articles become more "Facebook-like" and will not completely reflect your brand identity or design. From a marketing point of view, there is a risk of losing a visual connection with your target audience who will not experience the "look" and "feel" of your brand.

- **Ad Restrictions**

There are still some limitations when it comes to ads within Instant Articles. For example, ads cannot exceed 15% of the content and no autoplay videos.⁸

Overall, Facebook Instant Articles can be a compelling distribution channel for your content. That said, make sure it is part of your broader mobile marketing strategy.

6. Instant Articles Builder (<https://developers.facebook.com/docs/instant-articles/builder>)

7. Analytics for Instant Articles (<https://developers.facebook.com/docs/instant-articles/analytics/>)

8. Advertising overview (<https://www.facebook.com/business/help/252607612202707?id=858706964600987>)

Mobile Ads

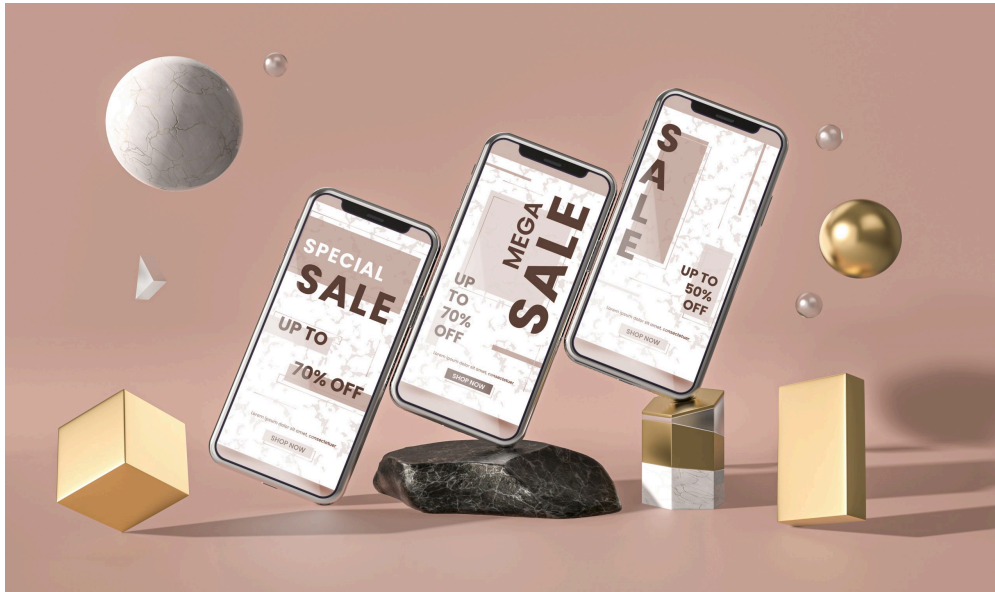

Most advertising networks like Google Ads, Facebook Ads, Twitter Ads, LinkedIn Ads, etc. allow marketers to target their ads to mobile devices. Mobile ad spending now exceeds desktop, which highlights the importance of this advertising channel.⁹ And according to eMarketer’s 2020 Global Digital Ad Trends, Canada is one of the fastest growing advertising markets with ad spending growing at 23%.¹⁰

Digital marketing agency, Marketo, also stated that Facebook mobile ads were five times (5×) more effective than their desktop versions. So, mobile advertising can clearly be an effective alternative to desktop advertising.

Given that these ads are displayed on mobile devices, it may present more convenient and direct ways for potential customers to connect with you, e.g., to call you. To do this, simply use the “call extension” option, e.g., in Google Ads, which allows the person to call your organization directly by simply clicking on your call-to-action button or link.

9. Mobile Marketing Statistics (<https://99firms.com/blog/mobile-marketing-statistics/>)

10. Fastest growing mobile advertising markets worldwide in 2020 (<https://www.statista.com/statistics/994000/mobile-ad-markets-growth-worldwide/>)

Types of Mobile Ads

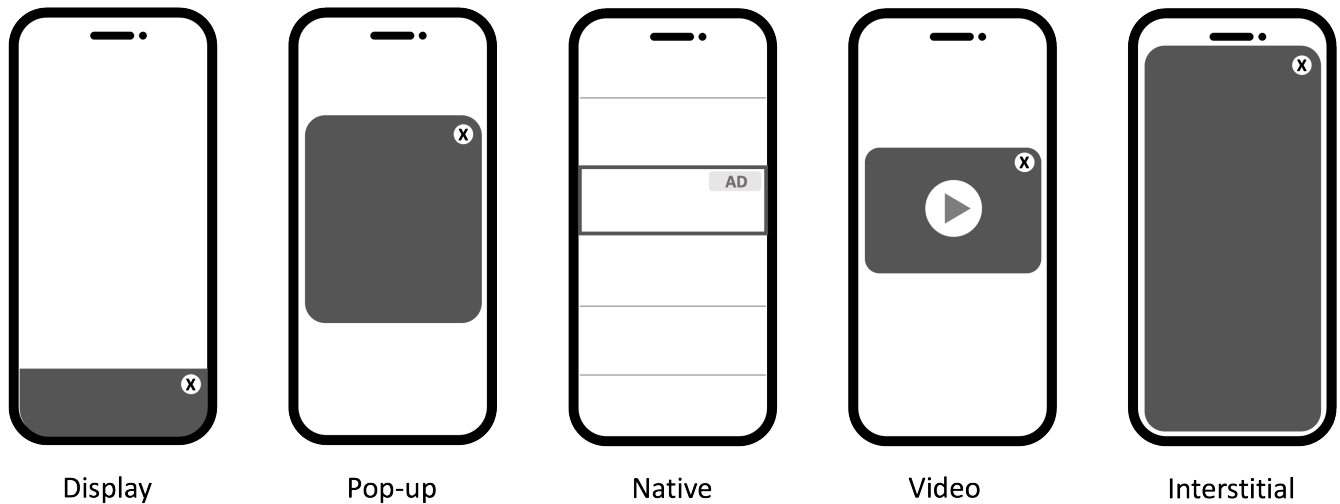

Like other digital marketing ads, there are a variety of mobile ad types. Depending on your goals, target audience, and the platform, you will need to select the appropriate type. That said, the following is a list of the most commonly used mobile advertising formats:

- **Display (Banner) Ads**

Display (banner) ads are the oldest version of mobile ads. Display ads are usually embedded directly on a webpage or in an app. In most cases, they use images (or graphics with text) that are designed to grab the audience's attention. Many of the same considerations for website display ads apply to mobile display ads. Even though display ads are cost-efficient and widely used, marketers are quickly exploring other options like interactive ads and video ads (described below).

- **Video Ads**

Video advertising is a powerful way to convert your target audience. Product videos can be particularly helpful during the purchase decision-making process. Videos can effectively deliver a full visual experience, which helps prospective customers better understand the products or services. And since more people are watching videos on their phones, optimizing YouTube ads and pre-roll video ads can potentially reach a very large audience / viewership. When creating mobile video ads, here are some tips for better ROI:

- Keep it simple
- Use your creativity
- Keep it short and focused
- Make sure the audio is not too loud
- Display a call-to-action

- **Full-screen or Interstitial Mobile Advertising**

Interstitial ads are the full-screen videos or graphics that are usually placed at app transition points. To remove or close them, users can usually click the X button (often in the top right-hand corner). Say, for example, you are playing a video game. You have just managed to

clear Level 1 and are ready to go to the next level. But, before moving on, you see an ad or a short video ad pop up. These are interstitial mobile ads.

Interstitial ads get higher click-through rates compared to display ads. However, show these ads only at transition points, so that you do not interrupt the content flow. Ad types may include text, graphics, or rich media. Since these ads fill up the entire or majority of the screen, they are hard to ignore and tend to get noticed.

- **Native App-based Ads**

Native ads are similar to display ads but are created to more closely match the style, design, and tone of the content in which they are embedded. Since the ads match the content and other elements of the app, they blend in much more seamlessly and more importantly, cannot be blocked. As a result, these ads get displayed to targeted audiences without causing significant interruptions in the flow of content. A popular example of native mobile advertising is Facebook ads. Users scroll through their page/news feeds and see ads (sponsored posts) inserted between non-paid / organic posts. To create high quality native mobile ads that highlight your brand, be sure to include the following key elements:

- Headline
- Detailed description
- Brand logo or name
- URL

- **Interactive / Playable Mobile Ads**

Interactive ads are a type of gamified video or multimedia ad. These are preferred by savvy marketers who want to create interactive advertising experiences. Games are a natural way to generate customers' interest. Playable mobile ads work especially well when marketing other apps. For example, if your app is about finding directions on a map, a playable mobile ad could provide a short and quick demo that lets users try a simplified version before downloading the app. These short interactive demos deliver a powerful ad experience, that ultimately gets prospective customers to spend more time interacting with the ad, engaging with the brand, and converting.

SMS & MMS

SMS stands for short message service and is often also referred to as a text message. MMS stands for multimedia message service and includes text messages with audio, video, or images. Many brands, such as Starbucks, have been using SMS successfully to advertise their products and promotions and drive real results. Specifically, Starbucks has used an SMS holiday campaign to offer holiday specials, weekly deals, and cheerful holiday messages. Many SMS campaigns have been quite successful, but if possible do consider MMS campaigns. Like other marketing activities, providing more interactive and visual content can help get your audience's attention and be more memorable. Set aside an appropriate budget and explore both of these underutilized options because they may deliver surprising results.

Location-based Ads

Location-based (*also called geofencing or geo-targeting*) ads refer to mobile marketing messages sent to a target audience based on their location. By tracking the location of the mobile device, marketers

can send targeted messages to individuals when they are within a specific geographic area. Many ad platforms like Google Ads and Facebook Ads allow marketers to specify locations or geographic areas where their ads will be shown.

Mobile Apps & Push Notifications

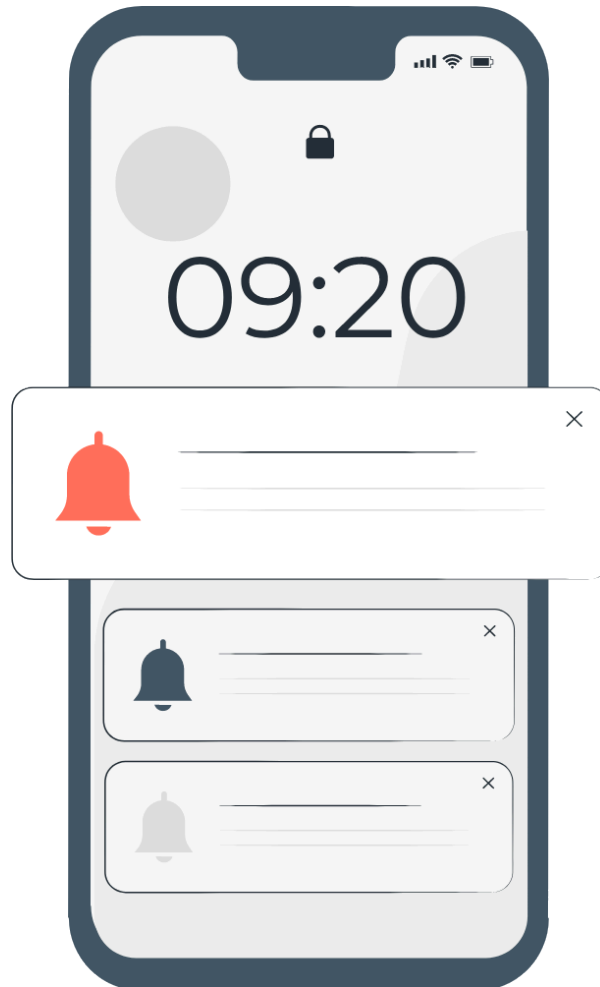

Mobile apps are programs that get downloaded onto your smartphone, smartwatch, or tablet. These apps usually serve a very specific purpose, e.g., email apps, social networking apps, or game apps. App-based marketing has risen quickly due to the increase in smartphone, smartwatch, and tablet daily usage.

Once an app has been downloaded, the app developer can communicate with the user via push notifications. Push notifications are messages or notifications that pop up on these mobile devices without the need to open the app. While these notifications only reach an audience of one, i.e., the smartphone user, they should push valuable information or insights directly to the user. To make sure that your push notifications are beneficial and not annoying, marketers should make sure their notifications follow these three tips:

- **Relevant and Timely**

Because notifications are disruptive, make sure your notifications are triggered by the user's behaviour, location, or preferences.

- **Personalized**

Since you have access to the individual's behaviour's, locations, and preferences, make sure the content of the notification appeals to them personally.

- **Actionable**

The notifications should make it clear what you want the user to do next. Without a specific action or request, it becomes easy for users to dismiss and ultimately, ignore your notifications.

The following types of push notifications generally perform well:

- Offer a promotion, e.g., a time-limited discount or something else that creates urgency
- Pique the user's curiosity
- Help users meet their goals, e.g., a fitness app that tells them it is time to workout
- Nudge users when they become inactive
- Remind users to do something
- Present an exciting update or event
- Make users feel like an insider
- Show a message preview, e.g., an email message preview
- Tell users when people they follow are active
- Make personalized suggestions
- Include multimedia

For more ideas, check out these 50+ push notification examples and inspirations to drive more engagement.¹¹

Now that we have covered what works, let's review a few practices to avoid. Steer clear of these common mistakes:

- **Generic Blasts**

Mobile users get push notifications all day every day. The last thing they need is to be the subject of a generic mass marketing campaign blast that isn't relevant to them. Make sure you segment your audience, so you are not contributing to the daily digital noise.

- **Wrong Time**

Make sure your notifications are localized to the user's time zone and be mindful of the most appropriate time to send them. A user who appreciates a midday work-related notification might be annoyed by the same notification when winding down to go to bed.

- **Clickbait**

While you do want to pique your user's curiosity, be sure to deliver on your notification promise. If not, you will simply annoy your user and they may start ignoring other notifications.

11. 50+ Push Notification Examples To Trigger Emotions In 2022 (<https://www.izooto.com/blog/50-push-notification-examples-to-get-inspired>)

- **Multimedia without Context**

Visual media like images, videos, and animated GIFs can make or break the user experience. When done well, these notifications can delight and engage users. But some mobile devices may struggle to display rich media properly. So, always make sure your message makes sense both with and without the multimedia content.

When you create and send push notifications, think like a user, and respect their time and experience. The more you understand your user, the easier it is to keep them informed, entertained, and engaged.

Mobile In-Game Ads

In-game mobile ads refer to ads placed within mobile games, which appear during gameplay. The ads that perform best and deliver the highest conversions are those integrated directly into the game such that they become an extension of the gaming experience. These seamless ad experiences can improve engagement, retention, and conversion rates.

Many marketers have concerns about the effectiveness of mobile in-game ads. However, in this article, *4 Common Myths about Mobile In-game Advertising*¹², author, Kori Wallace, refutes the following four myths:

- **Advertising interrupts the gaming experience**

A 2019 report done by Tapjoy states that gamers understand the role advertising plays in mobile games and even actively engage with ads.¹³

- **Gaming environments aren't brand safe**

When many people think of video games, they think of games that have “risky or adult content”. However, in the world of mobile games, most brands have found that the games, especially the free-to-play apps, are fairly brand safe.

- **Gaming is a niche audience** (*young males*)

Statistics show that gamers, especially those playing on mobile, are increasingly female. Certain types of mobile games, such as puzzles, draw even more women players than men. And they're not necessarily young gamers either. Jun Group research found that 56 percent of mobile gamers are age 35 and over.

- **It is impossible to measure success**

Mobile in-game advertising is quite measurable and in some cases, marketers can even integrate third-party tools to validate the analytics and results.

12. 4 Myths about mobile in-game advertising, debunked (<https://blogs.oracle.com/advertising/post/4-myths-about-mobile-in-game-advertising-debunked>)

13. The Modern Mobile Gamer – Personas 2019 Ebook (<https://www.tapjoy.com/lp/mobile-gamer-demographics-2019/>)

Action Codes



Action codes include scannable, visual codes like QR codes or bar codes (see images above). In many cases, these codes are presented offline, e.g., transit ads, posters, magazine ads, or product labels, and when scanned by mobile devices, people are sent to a related, online landing page. One very recent use of these codes has been the rise of digital menus in restaurants during the pandemic. Many restaurants simply printed QR codes and left them on their tables. Diners could then scan the codes to pull up the restaurant menu and this avoided the need to print menus or navigate pandemic safety issues with people sharing menus. QR codes have also been used to verify COVID-19 vaccinations. Now that more people have been using QR, there may be even more areas where marketers can use them.

Mobile Email

Reading emails on mobile phones is considered one of the top 5 activities for smartphone users globally. And according to a recent Mobile Ecosystem Forum survey of smartphone users in ten markets worldwide, almost five in 10 respondents preferred receiving business communications via email. So, mobile-friendly emails are essential in communicating and converting your target audiences. That said, marketers do need to provide compelling and valuable emails because if they do not, people will either delete or ignore their messages. In our next chapter, we will explore email marketing in more detail.

Keys to success

As you can see, there are many similarities between website and mobile advertising. However, to deliver a successful mobile marketing experience, consider the size of the screen, the communication opportunities, e.g., calling, the GPS capabilities, and the portability that make mobile experiences personalized, special, and unique. Take advantage of these built-in features to deliver richer and more interactive experiences for your mobile audiences.

Also, consider mobile marketing in conjunction with other marketing channels – online or offline. Success happens when all marketing channels support and promote each other, i.e., when your marketing activities are well integrated. Marketers are increasingly combining their social, local, and mobile activities, also called So-Lo-Mo, into one comprehensive strategy. Since social media is increasingly more mobile-friendly and mobile is targeting local customers and driving local conversions, the three areas work well to build on each other. This results in customer touchpoints across multiple marketing communication channels and strengthens a brand’s overall marketing and messaging strategies.

And, finally, don’t forget to personalize your mobile interactions and ads. Customers connect and respond best to personalized messages customized for them, whether that be by geographic area, specific location, or behaviours. For example, Best Buy and Subway use geo-location technology to deliver targeted messages to customers who have opted-in to their mobile marketing programs. Many marketers wonder about the willingness of their target audiences to opt into mobile marketing programs. However, a recent study by Google found that almost half of the women surveyed would share their location if offered a \$5 store credit. And, that percentage jumped to 83% when offered a \$25 store credit. So, with the appropriate incentive, marketers can encourage customers to participate in mobile campaigns and initiatives.

The following video provides a nice summary of many of the topics covered in this chapter:

Watch: What is Mobile Marketing? (2 mins) (<https://youtu.be/pyb-9N65M-M>)



One or more interactive elements has been excluded from this version of the text. You can view them online here: <https://opentextbc.ca/foundationdigitalmarketing/?p=109#oembed-1> (#oembed-1)

Key Takeaways

Mobile marketing refers to those activities that use and leverage mobile devices, e.g., tablets, phones, or watches, to connect with target audiences and to promote a brand’s products or services.

- To create your mobile marketing strategy, ask:
 - Where is our mobile strategy now?
 - Where do we want our mobile strategy to be in the future?

- How do we get there?
- There are many ways to present and distribute your mobile-specific marketing and advertising content:
 - Responsive website
 - Google AMP-enabled pages
 - Facebook Instant Articles
 - Mobile Ads
 - Display Ads
 - Video Ads
 - Interstitial Ads
 - Native Ads
 - Interactive / Playable Ads
 - SMS & MMS Ads
 - Location-based Ads
 - Mobile Apps & Push Notifications
 - Mobile In-Game Ads
 - Action Codes
 - Mobile Email
- Keys to successful mobile marketing include:
 - Leveraging the built-in features of mobile devices, e.g., cameras, calling, GPS, and portability
 - Integrating your mobile marketing strategy across all marketing channels
 - Personalizing your messages to match your target audience's behaviours, locations, and preferences

Mobile Marketing – Resources

To explore mobile marketing further, here are a few additional resources:

- **A Mobile Marketing Guide** (<https://www.evinex.com/mobile-marketing/>)
- **Google – Discover the Possibilities of Mobile** (<https://learndigital.withgoogle.com/digitalgarage/course/digital-marketing/module/16>) (20 min)
- **Google – Make Mobile Work for You** (<https://learndigital.withgoogle.com/digitalgarage/course/digital-marketing/module/17>) (35 min)

Media Attributions

- Responsive Web Design on devices (https://www.freepik.com/free-vector/responsive-web-design-devices_724794.htm) by freepik (<https://www.freepik.com/author/freepik>) is licensed under a Free License (https://www.freepikcompany.com/legal?_gl=1*8pne5p*fp_ga*NTMyNTAyODE1LjE2NTg0MzQ5OTE.*fp_ga_QWX66025LC*MTY1ODUzMzM5NC4zLjEuMTY1ODUzMTE5My4xMQ..*test_ga*NTMyNTAyODE1LjE2NTg0MzQ5OTE.*test_ga_18B6QPTJPC*MTY1ODUzMzM5NC4zLjEuMTY1ODU)

zMTE5My4xMQ..#nav-freepik-license).

- AMP ([https://www.seobility.net/en/wiki/AMP_\(Accelerated_Mobile_Pages\)](https://www.seobility.net/en/wiki/AMP_(Accelerated_Mobile_Pages))) by Seobility is licensed under a CC BY-SA 4.0 licence (https://www.seobility.net/en/wiki/Creative_Commons_License_BY-SA_4.0).
- Facebook instant articles © Facebook (<https://facebook.com>), for educational, non-commercial use only.
- Various mobile phones 3d mock-up and geometric shapes (https://www.freepik.com/free-psd/various-mobile-phones-3d-mock-up-geometric-shapes_7072441.htm) by freepik (<https://www.freepik.com/author/freepik>) is licensed under a Free License (https://www.freepikcompany.com/legal?_gl=1*8pne5p*fp_ga*NTMyNTAyODE1LjE2NTg0MzQ5OTE.*fp_ga_QWX66025LC*MTY1ODUzMMD5NC4zLjEuMTY1ODUzMTE5My4xMQ..*test_ga*NTMyNTAyODE1LjE2NTg0MzQ5OTE.*test_ga_18B6QPTJPC*MTY1ODUzMMD5NC4zLjEuMTY1ODUzMTE5My4xMQ..#nav-freepik-license).
- What is Mobile Marketing? (<https://www.youtube.com/watch?v=pyb-9N65M-M>) by Instapage (<https://www.youtube.com/c/Instapage>) is licensed under a Standard YouTube License.
- Types of mobile ads by Rochelle Grayson is licensed under a CC BY 4.0 licence.
- Push notifications by Rochelle Grayson is licensed under a CC BY 4.0 licence.
- Bar code and QR code by Rochelle Grayson is licensed under a CC BY 4.0 licence.

15.

Email Marketing

Learning Objectives

By the end of this chapter, you should be able to:

- **Explain** why email marketing is important to digital marketing
- **List** the seven steps of an email marketing campaign
- **Create** effective content for email marketing
- **Explain** the different types of email and how they are used
- **Describe** ways to prevent emails from being marked as spam
- **Evaluate** and improve email marketing performance



Email Marketing Role in Lead Generation Framework

Referring to our lead generation framework, email marketing plays a critical role in developing, nurturing, and closing leads. According to the Content Marketing Institute’s 2020 Benchmarks,

Budgets, and Trends Study, email marketing is the most effect content type in securing and nurturing leads and the second most effective in converting leads.¹



Let’s take a further look into a few key statistics related to email marketing that highlight why email marketing is often considered the content marketing workhorse in a marketer’s toolkit.

Why Email Marketing?

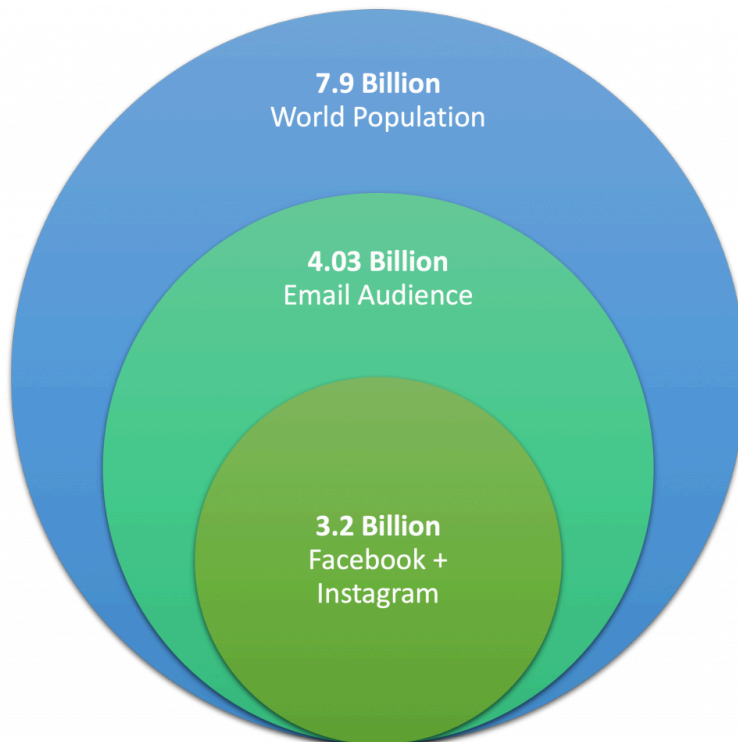

In 2021, 4.03 billion people around the world use email and that number is expected to reach 4.48 billion by 2024. That’s half of the world’s population; no other digital platform comes close to the

1. CONTENT MARKETING 2020 [PDF] (https://contentmarketinginstitute.com/wp-content/uploads/2019/12/2020_B2C_Research_Final.pdf)

potential reach of email.² The latest Facebook statistics report over 2.2 billion monthly active users and even adding Instagram's 1 billion+ users to that number does not compare to the reach of email.

And, in a recent Canadian Marketing Association survey, 81% of Canadians responded that they are comfortable receiving brand and company communications via email. In comparison, social media was in second place with 58%.³ What is also interesting is that overall, audiences' receptiveness to receiving brand messages regardless of channel is decreasing. This highlights the importance of providing valuable and insightful brand communications and in the appropriate channels so that your target audiences read your content. Many people are now separating their personal and professional social networks and as a result, marketers need to make sure their content is appropriate for each channel and what their target audiences expect. Clearly, email is an acceptable digital marketing channel for brand messaging.

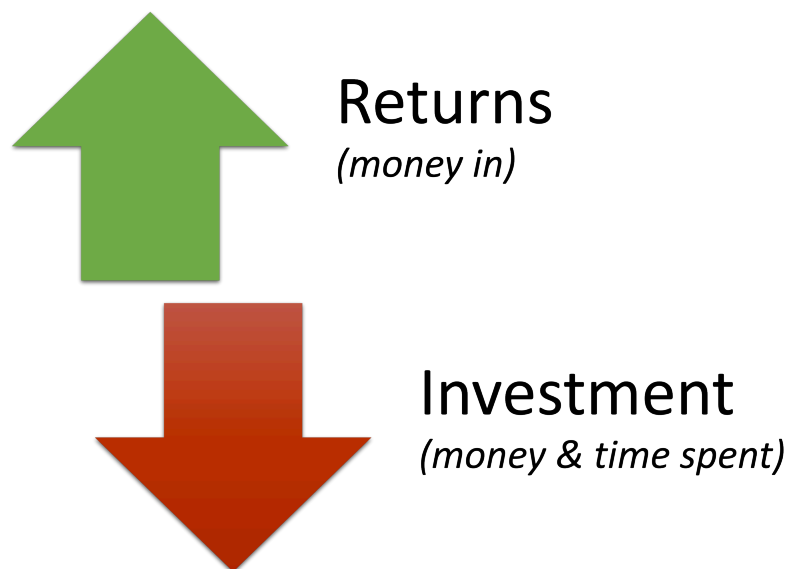

Another key benchmark to review is email's return on investment. **Return on investment (ROI)** measures how much revenue every dollar invested in a marketing campaign generates. In terms of ROI, email marketing delivers one of the highest returns on investment when done properly. This is largely because email marketing can be easier and cheaper to create and distribute and usually the target audience is already a somewhat qualified audience, i.e., subscribers have already expressed an interest in your brand, products, and services. In 2019, the average email ROI was \$42 for every dollar spent on email marketing, according to both DMA and Litmus.⁴⁵ In comparison, Google states that for every \$1 spent on Google Ads (PPC), businesses earn an average revenue of \$2. This is not to infer that PPC ads are not as valuable as emails; their main purpose is to attract new audiences and build brand awareness. However, marketers should note that email can be 20× more effective when it comes to ROI.

2. Number of e-mail users worldwide from 2017 to 2025 (<https://www.statista.com/statistics/255080/number-of-e-mail-users-worldwide/>)

3. Share of consumers who are comfortable with receiving brand and company communications via selected digital channels in Canada in 2018 and 2019 (<https://www.statista.com/statistics/553738/leading-methods-consumer-online-interaction-with-companies-canada/>)

4. Marketer email tracker 2019 [PDF] (<https://dma.org.uk/uploads/misc/marketers-email-tracker-2019.pdf>)

5. Email Marketing ROI: What leads to better returns? [PDF] (<https://www.litmus.com/resources/email-marketing-roi/>)

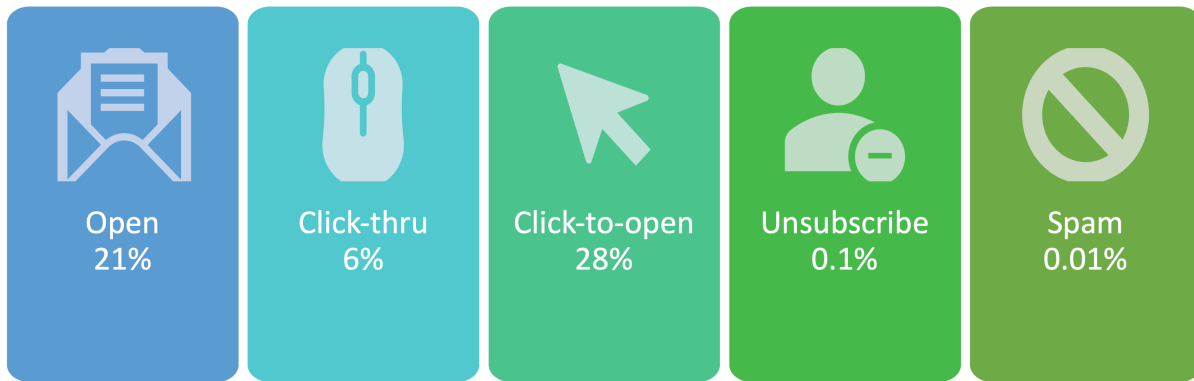

And, finally, based on the latest email benchmarking research from GetResponse (<https://www.getresponse.com/resources/reports/email-marketing-benchmarks>), the following email statistics are what Canadian marketers are seeing, on average:

- **Open rate (OR): 21%**
 $\text{Open rate} = \text{number of opened emails} / \text{number of emails delivered} \times 100$
 Keep in mind that all emails on your email list may not be successfully delivered. As a result, you may also want to monitor the delivery rate.
- **Delivery (or bounce) rate** = $\text{number of emails delivered} / \text{number of emails sent} \times 100$
- **Click-through rate (CTR): 6%**
 Email click-through rate (CTR) tells you the number of people who clicked on any of the links inside of your email.
 $\text{CTR} = \text{number of clicks} / \text{number of emails delivered} \times 100$
- **Click-to-open rate (CTOR): 28%**
 The click-to-open rate (CTOR) compares the number of people that opened your message with those who clicked on any of the links. This is an important metric to better understand how relevant and engaging your email content and calls-to-action were.
 $\text{Click-to-open rate} = \text{click-through rate} / \text{open rate} \times 100$
- **Unsubscribe rate: 0.1%**
 This is the percentage of email subscribers who, on average, unsubscribe.
- **Spam: 0.01%**
 This represents the percentage of subscribers who mark emails as spam.

H5P: Email Marketing Campaign Calculations

Now, let's practice calculating some email marketing rates ...

The following metrics are related to a recent email campaign:

- Total subscribers: 10,000
- Emails delivered: 8,500
- Opened emails: 3,060
- Links clicked: 400

- Conversions: 102

Given the above results, please calculate the following:

- Delivery / Bounce Rate:
 - Hint: Remember to present this as a percentage
- Open Rate:
- Click-through Rate:
 - Hint: Only one decimal place needed
- Click-to-open Rate:
 - No decimal places required

Even though we haven't provided the **specific** formulas, try to calculate the following rates based on your understanding of the other formulas:

- Conversion Rate:
 - Hint: It's **similar** to CTR (*only one decimal point required for the answer*)
- Conversion-to-open Rate:
 - Hint: It's **similar** to CTOR (*only one decimal point required for the answer*)

Please note that there can be significant differences in averages based on the industry, target audience, and most importantly, the type of email campaign sent. (*We will review the various types of email later in this chapter.*) For example, let's look at the average email statistics related to "internet marketing", which are as follows:

- **Open rate (OR): 15%**
This is slightly lower than the overall Canadian email open rate of 21%.
- **Click-through rate (CTR): 1.66%**
This is significantly lower than the 6% cited above.
- **Click-to-open rate: 11%**
This rate is more than 50% lower than the 28% cited across all industries. It appears the content in internet marketing campaigns may not be as compelling as in other industries. Do you have any ideas as to why these click rates might be so much lower?
- **Unsubscribe rate: 0.12%**
This percentage is 20% higher than the overall average, which means in internet marketing, subscribers are 20% more likely to unsubscribe. Although the overall percentage is still quite low.
- **Spam: 0.01%**
This spam rate is the same as the average.

For more industry benchmarks and details, do check out the full GetResponse study (<https://www.getresponse.com/resources/reports/email-marketing-benchmarks>).

Launching a Successful Email Campaign



Now that we have presented many reasons why marketers should consider and spend time on email marketing, let's dive into the seven steps to launch a successful email marketing campaign:

1. Define Your Target Audience and Goals & Objectives

As mentioned with all content marketing strategies, the first step is always to define your **target audience** (*remember your **customer personas!***) and set your specific email marketing **goals and objectives**.

2. Select an Email Service Provider (ESP)

Next, you want to choose your email service provider. An **email service provider**, or ESP, is a company that offers email marketing services. These providers differ from an email client (like Gmail or Outlook) because they allow marketers to send out emails in bulk, i.e., large quantities, and also offer advanced features that help marketers manage, target, automate, and measure their email marketing activities better. Mailchimp is one of the most popular email marketing service providers primarily because they offer a free email marketing service plan. However, depending on your needs, you may want to use a different service. Here is a fairly comprehensive list of popular email marketing services, including pricing and features (<https://www.adamenfroy.com/best-email-marketing-services>).

3. Build Your Target Email List(s)

After deciding on an ESP, you can use email sign-up forms to capture your target audiences' email address and add them to your email list. Due to the following anti-spam and data protection legislation, it is strongly recommended that marketers build their email lists from scratch rather than purchase lists because the penalties and repercussions can be quite severe:

Anti-Spam Legislation & Data Protection Laws

COMPARISON BETWEEN INTERNATIONAL ANTI-SPAM & DATA PROTECTION LAWS



GDPR



CASL



CAN-SPAM

Given the global nature of digital marketing, the following electronic communication laws are important to note and have significantly impacted and influenced how email lists are obtained and who marketers can send emails to.

- **General Data Protection Regulation (GDPR – EU)**⁶ Passed in 2016 and enforced starting in 2018, GDPR applies to both individuals and businesses. It is similar to CASL (more below), but extends opt-in rules to collection, sharing, and processing of personal information. GDPR requires renewed consent every time an organization wants to use personal information in a different way (with a few exceptions). Violation of this policy can result in up to €20 million in fines or 4% of annual global turnover (whichever is higher). One recent example is Amazon's €746 million GDPR fine, announced in the company's July 2021 earnings report.⁷ The full reasons behind the fine have not yet been confirmed, but the cause has to do with cookie consent. Unfortunately, this is not the first time Amazon has been punished for the way it collects and shares personal data via cookies. In late 2020, France fined Amazon €35 million it allegedly failed to get cookie consent on its website. While it is tempting to force users to "agree" to cookies—or make opting out of cookies difficult—to collect as much personal data as possible, European regulators are seriously enforcing the EU's cookie requirements. If Amazon had obtained "freely given", informed, and unambiguous opt-in consent before setting cookies on its users' devices, the company probably could have avoided this huge GDPR fine.
- **Canadian Anti-Spam Legislation (CASL – Canada)**⁸ Passed in 2019 and enforced starting in 2014, CASL applies to both individuals and businesses. It requires marketers to have subscribers opt-in with verbal or written consent before receiving any commercial electronic messages (CEM), which includes email, SMS, audio and video, sent within Canada. This also applies to any messages routed through Canadian servers and prohibits intrusive software like spyware and malware. There are two types of consent under CASL – express and implied. Express consent does not expire; however, the recipient has the right to withdraw their consent at any time. And, the onus is on the person sending the message to prove they have obtained consent to send the message. Violations of this policy can result in up to \$1 million in fines for individuals and \$10 million per business. Here is a list of the latest CASL violations and the fines

6. Data protection Rules for the protection of personal data inside and outside the EU. (https://ec.europa.eu/info/law/law-topic/data-protection_en)

7. Why Amazon's £636m GDPR fine really matters (<https://www.wired.co.uk/article/amazon-gdpr-fine>)

8. Canada's Anti-Spam Legislation (CASL) (<https://crtc.gc.ca/eng/internet/anti.htm>)

associated with them (<https://crtc.gc.ca/eng/ce/actions.htm#casl>).

- **Controlling the Assault of Non-Solicited Pornography and Marketing Act (CAN-SPAM – US)**⁹
Passed in the US in 2003 and enforced starting in 2004, CAN-SPAM applies to any commercial electronic mail messages (emails) and requires marketers to offer all subscribers an opt-out option on all communications. And, if an organization is found violating this policy, it can be fined up to \$41,484 (adjusted for inflation) for each separate email in violation.

4. **List Management**

Many marketers think that having an email list with as many email addresses as possible is the goal. In fact, it is much more important to keep your email lists up-to-date and “clean”. Having an email list with lots of subscribers who do not open or interact with it can impact your delivery rates and ultimately, may lead to your messages to be viewed as spam. To ensure that your subscribers want to receive your email messages, offer double opt-in, e.g., confirm consent by sending a follow-up email with a confirmation link to the subscriber’s email address. You also want to provide clear unsubscribe directions in every communication. And, if you do have subscribers who are not engaging with your content, move them to a separate email list, i.e., segment them out, and target them using a re-engagement campaign (more about this later in the next section). If appropriate, you may also want to segment your email list based on interests, location, purchase behaviours, etc. Email list segmentation is valuable because it ensures your marketing messages are meeting the specific needs of that segmented audience.

5. **Decide on the Type of Email**

Now that you have built your email list(s) and know the interests and needs of each list, you should decide on the type of email you want to send. Most emails fall into two primary categories:

- **Triggered Emails**

Triggered (or transactional or behavioural) emails are emails sent automatically based on pre-defined events or conditions met by an individual through certain behaviours, actions, or other signals. The most common triggered emails are welcome emails. These emails are sent immediately after someone signs up and welcomes them with tips, links, information about their login information, etc. Triggered emails tend to have significantly higher open rates because they are tied to a recent activity and the recipient is usually interested in the information provided. For example, open rates for triggered emails are around 40% vs 20% for newsletters.¹⁰ To execute these best, you will need to setup an automated email campaign, sometimes called a drip campaign, so that your ESP knows when to send the appropriate email. When setting up a triggered email campaign consider:

- **Which Triggered Emails to Include**

9. Enforcement actions (<https://crtc.gc.ca/eng/ce/actions.htm#casl>)

10. Tactics. Average Results by Message Type. (<https://www.getresponse.com/resources/reports/email-marketing-benchmarks#tactics>)

An automated drip campaign typically includes 3 – 5 separate emails. Depending on the nature of the campaign or organization, some email types may be less appropriate.

- **Timing for Each Email**

A welcome email should come very quickly, but timing of the remaining emails could be 1, 2, 5, or 10 days apart and earlier triggered emails may come in quicker succession than later emails.

- **Content Dependencies**

A new subscriber who opens and clicks on every new email should be treated differently than a new subscriber who fails to open the onboarding emails. Similarly, an “exit survey” would only go to those who did not upgrade or respond to prior emails. These are examples of a dependency that would need to be built into the email automation.

- **Content within Each Email**

In Step 5, we will go into more detail about how to design and craft your email content.

- Below are several examples of common triggered emails:

- | | |
|------------------------------------|---|
| ▪ Welcome emails | ▪ up-selling) emails |
| ▪ Account creation emails | ▪ Order status emails |
| ▪ Password reset emails | ▪ Reorder emails |
| ▪ Abandoned cart emails | ▪ Purchase receipt emails |
| ▪ Order confirmation emails | ▪ Account balance updates |
| ▪ Thank you emails | ▪ Review request emails, i.e., asking new customers to leave a review |
| ▪ Complementary product (cross- or | |

- **Informational Emails**

Informational emails represent the second category of emails. These emails inform, educate, or entertain and here is a list of content usually included in informational emails:

- | | |
|---|---|
| ▪ Industry articles | ▪ new products |
| ▪ Product testimonials | ▪ Upcoming events calendars |
| ▪ Customer success stories or spotlights (case studies) | ▪ Contest announcements |
| ▪ Educational articles | ▪ Featured quotes |
| ▪ Links to useful sections of your website | ▪ Surveys, polls, and feedback |
| ▪ Questions and answers | For some visual examples of both triggered and information emails, please do check out this article, 13 Types of Emails You Need to Be Sending Your Email List (https://optinmonster.com/13-types-of-emails-you-need-to-be-sending-your-email-list/). |
| ▪ Special offers or coupons | |
| ▪ Expert opinions | |
| ▪ Tips and advice | |
| ▪ Product reviews and announcements of | |

6. Create and Your Design Content

Once you have decided on the type of email you will be sending, it is time to focus on creating and designing your email content. When you are composing your email, you should note that there are some practices that may result in your emails being marked as spam. The following common “spam triggers” are ones you will want to avoid:

- **All Caps**
Offers and promotions in all caps are often spam. So, do not “scream” at your subscribers, and find other ways to show your excitement and enthusiasm.
- **“Spammy” Content**
Spammy content is content that is misleading, sensational, and of no use to the reader. Make sure your email messages provide value and match the interests of the reader.
- **High Image-to-Content Ratio**
A way spammers try to avoid email clients scanning their messages is to put text into an image. As a result, if an email has lots of images without many words describing those images or sentences providing context, there is a possibility that your email could be marked as spam. If you do use imagery extensively, be sure to use the HTML alt text tags to explain what is in the image and share some context as to why it is being included.
- **Poor HTML coding**
This could come up if you are manually coding and/or sending out your emails. For example, best practices include sending out both HTML / plain text versions and giving the subscriber the option to view the email in a web browser. If you use an ESP, these practices are built into those services and are why it is beneficial to use an ESP.
- **Exclamation Marks**
Once again, spam messages often include excessive exclamation marks. Please note that you can include these; just use them sparingly.
- **Embedded Forms**
While it is attractive to collect information from your subscribers directly within an email, it is also a tactic spammers use to get readers to share personal and secure data. If you have a form, include a link to it so that subscribers know where it is being collected and that it is associated with your organization.
- **Videos**
While studies show that videos in emails do increase interactivity and engagement, spammers also use videos to circumvent monitoring.¹¹ So, like images, use videos carefully, and make sure you provide context.
- **Attachments**
Sometimes attachments cannot be avoided. Unfortunately, spammers also use attachments to deliver malware or viruses. If possible, try to avoid including attachments and simply provide a link where subscribers can download or access

11. 13 Types of Emails You Need to Be Sending Your Email List (<https://optinmonster.com/13-types-of-emails-you-need-to-be-sending-your-email-list/>)

the file. Now that we've discuss several spam triggers, let's shift our focus to making sure the other elements of your emails are strong and appropriate.

- **Subject Lines**

There used to be a strong recommendation to keep subject lines short (less than 60 characters) because they might get cut off in the recipient's email client.¹² However, recent studies have shown that longer, more descriptive subject lines can perform equally well, if not better. What is important is to have your subject line be straight forward, descriptive, and compelling. Marketers may also want to limit punctuation, e.g., less than 3 punctuation marks per subject line, use emojis carefully, and avoid hard selling. Although, as with any recommendation, test to make sure. In our **A/B testing chapter**, we discuss testing best practices in more detail. That said, the following is a list of the most popular types of subject lines:

- Interests or Benefits Specific to the Recipient
- Curiosity
- Offer
- Urgency / Scarcity
- Personal
- News
- Social Proof
- Story

- **Sender and Recipient Fields**

Use a familiar sender name, e.g., Alex Miller, as opposed a generic organizational name. Open rates tend to increase with email personalization, i.e., when both the "To" and "From" fields are personalized. So, whenever possible try to capture the name of the subscriber to better personalize your messages.

- **Preview / Preheader Text**

Most email templates have an area at the top of the email that gets shown in the email client prior to opening the message (see red box below).

MarketingCharts The Changing Role of Marketing | Future of Identity Solutions | And More... The latest data and charts from MC Featured articles: Almost 3 in 4 CMOs Say Marketing's Importance Has Risen in the Past Year ...

Take advantage of this content and present specific subscriber benefits included in the email. More descriptive preview / preheader text also increases open rates.

- **Imagery**

Once again, use Alt tags to describe all your email images and videos.

- **Body Content**

Keep emails short and focused. The goal with most emails is to nurture and convert your subscribers. Shorter and more frequent exchanges are a better strategy than longer and less frequent ones. If possible, break up your content into shorter pieces; this will give you more opportunity to engage with your audience and keep their attention. Along these lines, also limit your calls-to-action (*remember the attention ratio?*) Fewer calls-to-action keep your emails focused and allow you to better assess your audiences' interests based on their engagement with each email. While entertainment can work well for B2C campaigns, B2B content should focus on value-based, informational, and profit-based topics, which also work for B2C audiences. That said, always test to find out what specifically resonates with your

12. Tactics. Average Results by Message Type. (<https://www.getresponse.com/resources/reports/email-marketing-benchmarks#tactics>)

target audiences.

There are several services that can help identify “spam triggers”. Here are a few that provide feedback to optimize your emails for improved deliverability:

- **Mail-Tester**¹³

Every time someone visits Mail-Tester.com, they’ll see a treehouse with a auto-generated email address listed on it that changes every time you visit the site. Simply send your email to the address listed, then click “Check Your Score.” Mail-Tester will give you a free email deliverability score based on the email that was sent to the unique email address. Free users can access the report for seven days. Paid subscribers get unlimited email tests and reports that last for 30 days.

- **Landing Pages**

After developing the content for your email messages, make sure the wording, sentiment, imagery, and calls-to-action are consistent with any **landing pages** related to those emails. You want the messaging to be the same and to deliver on what you discussed in the email.

7. Schedule & Automate

Even though there are numerous articles that will suggest the best time(s) to send emails, the best time to send your emails will largely depend on your **target audience**. Think about when your audience is most likely to check their inboxes and when will they have time to read your content. For example, if your target audience is university students, you might want to send your emails in the late evening after they have finished their classes. Sending an email in the middle of the day may not be seen if they are busy working or attending classes. Optimal timing is something you can easily test. It is recommended that you send out emails at different times and on different days to see which combinations result in the highest subscriber engagement and conversions. Only through your own primary research will you truly understand the best times to send out emails to your target audiences.

For triggered emails, scheduling will usually be tied to specific events, actions, or behaviours. In these cases, you will want to use an automated email system that allows you to determine and program a specific sequence and timing of emails, i.e., when each email will be sent and based on which triggers. In this article, Best Email Automation Tools, the authors review several ESPs that work particularly well for advanced, automated / triggered email campaigns.¹⁴ Their shortlist includes:

- **Sendinblue**¹⁵
- **Mailchimp**¹⁶
- **Mailjet**¹⁷
- **Drip**¹⁸

13. Mail-Tester (<https://www.mail-tester.com/>)

14. Best Email Marketing Automation Tools: Sendinblue vs Drip vs ConvertKit vs Mailchimp vs Mailjet vs Infusionsoft (<https://www.codeinwp.com/blog/best-email-marketing-automation-tools/>)

15. Sendinblue (<https://www.sendinblue.com/>)

16. Mailchimp (<https://mailchimp.com/en-ca/>)

17. Mailjet (<https://www.mailjet.com/>)

- **ConvertKit**¹⁹
- **Infusionsoft**²⁰

8. Test, Measure, and Iterate

To optimize your email activities, it is critical to test, review your results, and adapt. Even though email marketing can have a high ROI, it is still necessary to review your results to understand what is working and what is not. Test your sending times, subject lines, calls-to-action, and content. While there are many email marketing recommendations, much depends on your target audience, specific email content, and industry. In the next chapter, we will dive into **A/B testing** and email marketing is one area where you can apply A/B testing techniques quite effectively.

Key Takeaways

Incorporate your email marketing strategy into your overarching content marketing strategy, content calendar, and lead nurturing strategies

- Email marketing has the highest potential reach and ROI of all digital marketing channels
- To analyze your email marketing activities, calculate, review, and compare the following rates relative to industry benchmarks and results from your previous email campaigns / activities:
 - Delivery (or bounce) rate
 - Open rate
 - Click-through rate
 - Click-to-open rate
 - Conversion rate
 - Conversion-to-open rate
 - Unsubscribe rate
 - Spam
- There are seven key steps to launching a successful email campaign:
 1. Define your target audience and goals & objectives
 2. Select an email service provider (ESP)
 3. Build a target email list
 4. Determine the type of email – triggered or informational email
 5. Create and design the email content
 6. Schedule and automate the sending of emails
 7. Test, measure, and iterate to optimize your email marketing results and ROI
- Use your **customer personas'** interests, motivations, goals, challenges, pain points, etc. to drive your original and curated email content topics. (Remember the important role of **curated content**?)
- Craft compelling subject lines and email content for your **target audience**. Remember to use your **keywords and key**

18. Drip (<https://www.drip.com/>)

19. ConvertKit (<https://convertkit.com/>)

20. Infusionsoft (<https://keap.com/>)

phrases in your email content, as well.

Email Marketing – Additional Resources

Below are several articles and an industry certification that provide more details and tips about email marketing:

- 9 Email Marketing Services for Small Business Websites, Blogs and eCommerce Sites (<https://websitesetup.org/best-email-marketing-services/>) (*incl. features & pricing plans*)
- 101 Top Email Subject Lines of 2020 (<https://www.digitalmarketer.com/blog/101-best-email-subject-lines/>)
- The Ultimate List of Email SPAM Trigger Words (<https://blog.hubspot.com/blog/tabid/6307/bid/30684/the-ultimate-list-of-email-spam-trigger-words.aspx>)
- 29 Email Deliverability Tips for 2021 (<https://blog.hubspot.com/blog/tabid/6307/bid/30594/a-marketer-s-guide-to-getting-past-email-spam-filters.aspx>)
- 21 B2B Email Examples / Templates (<https://www.superoffice.com/blog/b2b-email-marketing-examples/>)
- Email Marketing Benchmarks (<https://www.getresponse.com/resources/reports/email-marketing-benchmarks>)
- Hubspot Email Marketing Course – Free (<https://academy.hubspot.com/courses/email-marketing>) (3 hrs.)

Media Attributions

- Email marketing role in lead generation framework by Rochelle Grayson is licensed under a CC BY 4.0 licence.
- Email marketing results from Content Marketing Institute study by Rochelle Grayson is licensed under a CC BY 4.0 licence.
- Email global audience by Rochelle Grayson is licensed under a CC BY 4.0 licence.
- Return vs investment by Rochelle Grayson is licensed under a CC BY 4.0 licence.
- Average Email statistics Canada by Rochelle Grayson is licensed under a CC BY 4.0 licence.
- Steps for a successful email marketing campaign by Rochelle Grayson is licensed under a CC BY 4.0 licence.
- Anti-spam legislation comparison – GDPR, CASL, CAN-SPAM by Rochelle Grayson is licensed under a CC BY 4.0 licence.

III

Analyzing and Optimizing Your Digital Marketing Performance

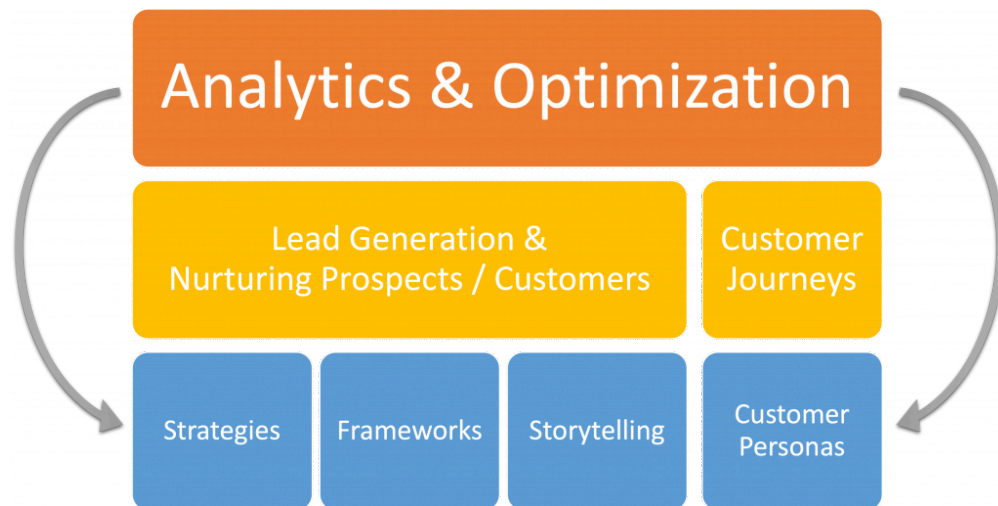

Congratulations, you have covered the first two of three core sections:

- I. Fundamentals in Digital Marketing
- II. Generating Customer Demand and Nurturing Leads & Prospects
- III. Analyzing Your Digital Marketing Performance

In this final section, we will focus on analyzing and optimizing your digital marketing results and outcomes. To accomplish this, we will cover:

- the fundamentals of A/B testing,
- digital marketing attribution models,
- conversion rate optimization, and
- common digital marketing analytics and calculations.

Media Attributions

- Digital marketing textbook structure by Rochelle Grayson is licensed under a CC BY 4.0 licence.

16.

A/B Testing

Learning Objectives

By the end of this chapter, you should be able to.

- **Describe** what A/B testing is and how to use it
- **List** several common areas to A/B test
- **Explain** the required steps to conduct an A/B test
- **Name** several online tools that support A/B testing

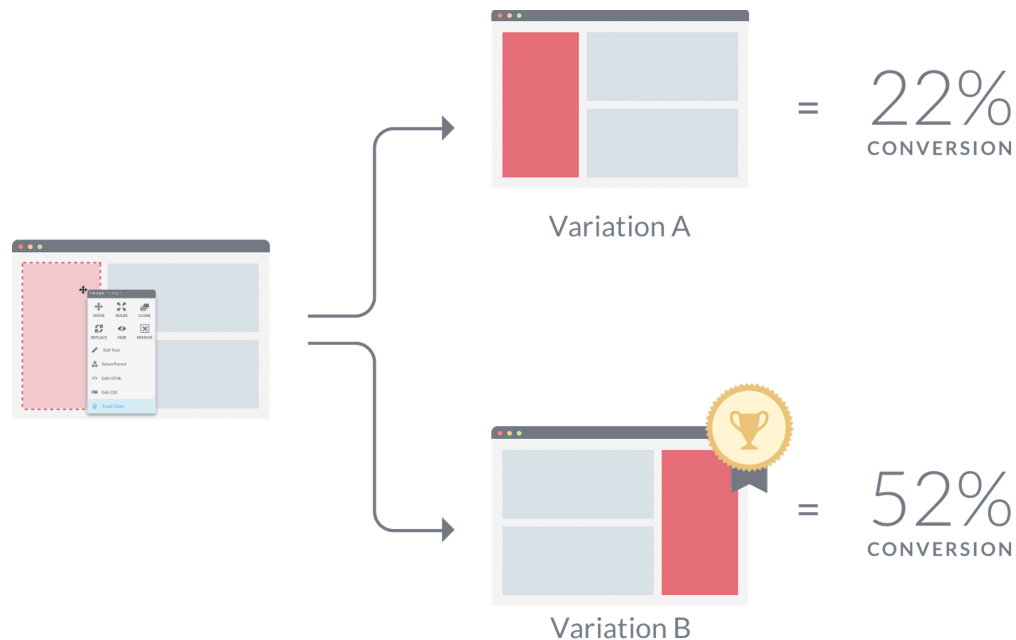

In its simplest form, **A/B testing** (also known as split testing) is the process of comparing two variations of a marketing asset, e.g., a webpage element, call-to-action, landing page, email, etc., usually by testing users' responses to Variant A vs. Variant B and concluding which of the two variants is more effective (see figure above).

Why You Should A/B Test Your Marketing Activities

Many marketing departments rely on A/B testing because it is one of the most effective ways to **tailor**

your approach to customers. While data and trend analyses are important elements in designing engaging web pages, A/B testing provides practical, tangible evidence of your most impactful marketing techniques.

Modern online metrics and analytics also make it easy for you to evaluate the results of your A/B testing. With analytics, you can easily monitor key metrics, including:

- how many people were exposed to each version,
- how long they interacted and engaged and most importantly,
- what percentage completed the campaign goal and converted.

An A/B test takes a significant amount of guesswork out of marketing. For example, if you think of a new marketing approach that could improve your company's performance, you can set up an A/B test and then monitor the data. If you're right and the new option gets better results, you can move forward with your new plan. If the original technique still performs better, you can continue with your regular routine and think of different marketing approaches in the future. Ultimately, A/B testing helps you make decisions based on data. This way you know when a particular marketing tactic or campaign is working. Or, more importantly, when one is failing.

Since every organization is different, don't assume that what worked for others will automatically work for you. When you A/B test your marketing activities and content, experiment with different ideas. This is useful because sometimes a small change can make a big difference in the results you get.

Reflect:

Think about a marketing activity or piece of content. Where might you conduct an A/B test and how might you test different ideas?

Common Areas to A/B Test

While not exhaustive, the following list presents several common key areas where marketers A/B test:

- **Headlines and subheadings**
Whether it is the "titles" on a webpage, headlines for a piece of content, or the subject line of your email, you may want to experiment with these to see if small changes make a difference in engagement rates.
- **Copy**
Copy is simply the text that you have written in your marketing materials. While copy can include the words and text itself, copy can also include the location of your text. Presenting two options and seeing which version is more engaging and/or converts more people could be an area to explore.
- **Form design**
When you look at your forms and the fields to be filled out, think about the number of fields and the information requested to see what potential leads submit and when completion rates

drop significantly.

- **Calls to action (CTA)**

As marketers, having compelling calls-to-action (CTAs) is critical to getting leads to convert. Testing a variety of options provides data on which words deliver the best results. Here's an article explaining **how you can test CTAs using Hubspot** (<https://knowledge.hubspot.com/cta/a/b-test-your-calls-to-action-ctas>).

- **Images**

Like CTAs, you can test different images and image types. For example, try different photos to see which one(s) capture your audience's interest more. You might even explore different types of imagery, e.g., photos, icons, clip art, etc.

- **Colours**

And, finally, sometimes colour can have an impact in how your target audience behaves. Testing contrasting colours, brighter colours, etc. can often provide insights as to what catches your target audience's attention and what they prefer.

For more A/B testing ideas, here's an article, **60 A/B Testing Examples to Get You More Conversions** (<https://optimmonster.com/8-ab-tests-to-run-on-your-popups-to-get-more-email-subscribers/>).

How to Conduct an A/B Test

Now that you know what an A/B test is and several potential areas to test, let's discuss how to conduct an A/B test. If you're ready to begin taking advantage of A/B testing to find the best marketing activities for your organization, here is what we recommend:

1. **Gather insights**

Before starting your split tests, gather any information you have about your customers. This can include both direct observations about your customers and industry insight data about ideal characteristics related to your target audience's preferences. The more detailed your understanding of potential customers, the easier it will be to get positive results from your campaigns. Remember your customer personas?!

2. **Set your goals**

Not all marketing activities have the same goals. For example, the metrics you will monitor for a brand awareness campaign will be different than those for a campaign focused on maximizing sales. Having a clear goal in mind makes it easier to know which metrics to focus on. We will provide more examples and details in the **Digital Marketing Analytics** chapter.

3. **Create a theory**

Once you have your target audience defined and a goal in mind, you can create a marketing theory. This is often called your "hypothesis". Determine what you *think* will be an effective method for your target audience to achieve the goal you are seeking. This theory will set the framework for your different testing options. For example, your hypothesis might be that the colour of the CTA button affects the number of clicks and conversions.

4. **Build your variations**

Although most content systems will allow you to perform A/B tests with many different variants, it is usually best to limit each round of testing to two or three variations. This allows you to quickly hit sufficient traffic numbers or volume for each option so you can compare them. It also makes it easier to isolate differences in the options to determine which technique led to better results.

5. **Run A/B tests**

After building your variants, it is time to launch them and allow the A/B tests to run. There is no perfect sample size. Instead, the right size depends on your marketing priorities. Targeting a smaller sample size will allow you to analyze your results and adjust more quickly and at a lower cost, while targeting a larger sample size provides you with more information to support larger-scale decisions. Clearly, there are pros and cons to each approach. So, the decision will be based largely on your goals, objectives, and levels of confidence required.

6. **Analyze the results**

Once you have gathered enough data to make an informed decision, you can begin looking at the data gathered. Make note of the key metrics you are tracking as a priority, but do not entirely ignore other metrics. For example, if you are running a campaign to build brand awareness and discover that one version is generating significantly higher sales numbers, while this may not make it the ideal option for the current campaign, it still provides valuable

information you can use to monetize other campaigns. The winning option is the one that is performing best, and that version should become the basis for your activities as you move forward.

7. **Make adjustments as needed**

After you discover which option won the A/B test, adjust your activities as needed. If the metrics for the winning variant are clear, expose your entire target audience to that option. If it is somewhat unclear which option is clearly the winner, perform a new A/B test by adding in new options and test against the leading variation. When testing new versions against the previously leading variation, take results from the first test into account when deciding on the best option.

8. **Continue monitoring**

Even after multiple rounds of A/B testing, you will still need to regularly monitor your marketing activities to ensure they are still effective. Marketing tactics will commonly reach points of diminishing returns, either as the content becomes less relevant or you begin to run out of potential ideas for a specific campaign. Make a habit of monitoring the campaign's performance even after you have found a winning variant and exposed the entire audience to it. Should performance begin to slip, you can end the campaign or return to Step 1 and go through a new round of A/B testing.

For a quick summary of A/B testing, here's a 4-minute video, [What is A/B Testing? | Data Science in Minutes](https://youtu.be/zFMgpxG-chM) (<https://youtu.be/zFMgpxG-chM>):



One or more interactive elements has been excluded from this version of the text. You can view them online here: <https://opentextbc.ca/foundationsdigitalmarketing/?p=126#oembed-1> (#oembed-1)

One additional term you should be aware of is multivariate testing. **Multivariate testing** is a technique for testing a hypothesis in which multiple variables are modified. The goal of multivariate testing is to determine which combination of variations performs the best out of all of the possible combinations (see image below).

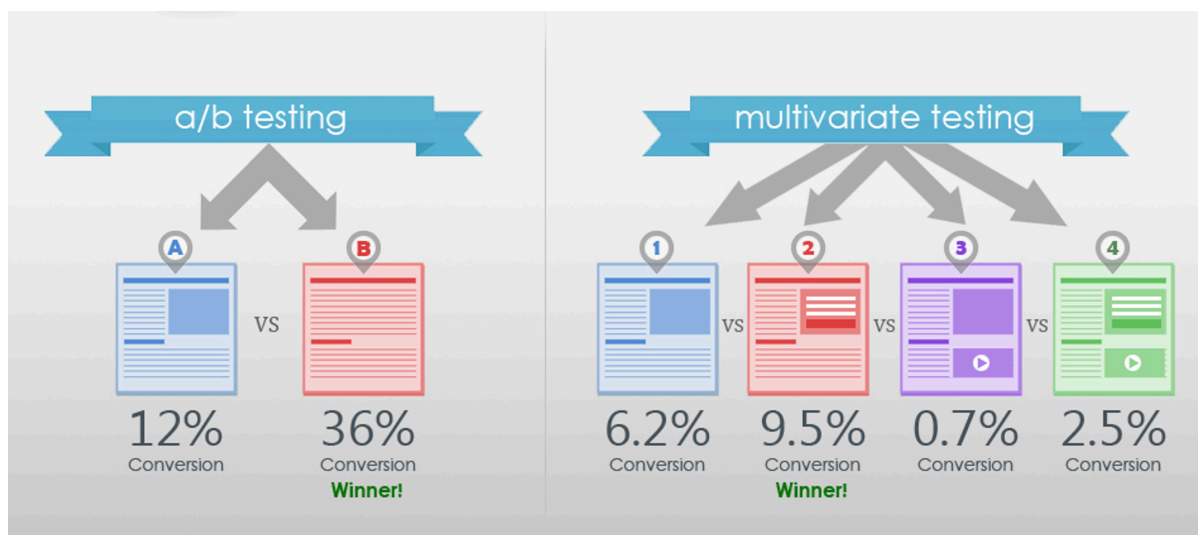

Tools for A/B Testing

Now that you understand what A/B testing is and how to conduct one, the following links provide a few frequently used tools for A/B testing:

(Please note that the tools listed below are all free or offer free trials.)

- **Google Optimize** (<https://marketingplatform.google.com/about/optimize/>) – Google Optimize is a Google tool that lets you test and tailor different variations of your website. The main selling point of Google Optimize is its native integration with Google Analytics, allowing you to gain automatic access to rich behavioural insights. You will also be able to target the valuable segments you have already discovered using Analytics. Try out Google Optimize for free and upgrade to Google Optimize 360 for enterprise-level website testing and personalization. Here’s a quick video overview:



One or more interactive elements has been excluded from this version of the text. You can view them online here: [#oembed-2](https://opentextbc.ca/foundationdigitalmarketing/?p=126#oembed-2)

- **Kameleoon** (<https://www.kameleoon.com/en>)– Kameleoon is an advanced optimization platform that offers a variety of features. Using Kameleoon, can run advanced A/B, split, and multivariate tests quickly and easily. You can also see key user insights with their navigation analysis tool and test different user segments with over 40 targeting criteria. Dynamic traffic allocation algorithms also make sure your traffic is optimally divided in order to shorten your decision cycle and improve return on investment. You can get started on Kameleoon by creating a free account and upgrade to an enterprise plan if the tool suits your needs.



One or more interactive elements has been excluded from this version of the text. You can view them online here: [#oembed-3](https://opentextbc.ca/foundationdigitalmarketing/?p=126#oembed-3)

- **Symplify** (<https://symplify.com/conversion/>) (*formerly SiteGainer*) – Symplify is a company that offers a full suite of conversion optimization tools, including A/B testing, multivariate testing, personalization, heat maps, popups, and surveys. They also have a team of experts to assist you with test ideas, design, programming, analytics, and personalization. Symplify offers a free trial. Pricing plans are based on monthly traffic, payment schedule, and additional services.

For more options, reviews, and pricing details, please check out this article, **24 A/B Testing Tools** (<https://www.convertize.com/ab-testing-tools/>). In this article, they make the following recommendations:

- The Best Solutions for Large Businesses:

1. **Symplify** (<https://symplify.com/conversion/>)
 2. **Optimizely** (<https://www.optimizely.com/>)
 3. **Google Optimize 360** (<https://marketingplatform.google.com/about/optimize/>) (the integrations alone make this a great option)
- The Best A/B Testing Tools for Marketing Teams:
 1. **VWO** (<https://vwo.com/>) (if you have the budget)
 2. **Convertize** (<https://www.convertize.io/>)
 3. **Freshmarketer** (<https://www.freshworks.com/crm/features/conversion-rate-optimization/>)
 - The Best A/B Testing Tools for Small and Medium-Sized Business:
 1. **Convertize** (<https://www.convertize.io/>)
 2. **Zoho Pagesense** (<https://www.zoho.com/pagesense/>)
 3. **OmniConvert** (<https://www.omniconvert.com/>)
 - The Best Landing-Page Tools:
 1. **Unbounce** (<https://unbounce.com/>)
 2. **Clickthru** (<http://www.clickthru.com>)

The A/B testing software market is in a healthy place, with solutions for every size and type of business. Most of the options in **the above list**¹ include a free trial (some as long as 60 days), so there is no reason not to try them for yourself.

Key Takeaways

- A/B testing (also known as split testing) is the process of comparing two variations of a marketing asset and concluding which of the two variations is more effective. A/B testing can be applied to:
 - Webpages
 - Elements within a webpage
 - Calls-to-action
 - Landing pages
 - Emails
 - Images and more
- To conduct an A/B test, follow these steps:
 - Gather insights
 - Set your goals

1. Comparison of the 24 Best A/B Testing Tools in 2022 (<https://www.convertize.com/ab-testing-tools/#ab-testing-tools-comparison>)

- Create a theory / hypothesis
- Build your variations
- Run A/B tests
- Analyze the results
- Make adjustments as needed
- Continue monitoring

A/B Testing – Additional Resources

Below are some articles with more details about A/B testing:

- How to do A/B Testing and Improve Your Conversions Quickly (<https://www.crazyegg.com/blog/ab-testing/>)
- 19 Best A/B Testing Tools in 2021 (<https://www.ventureharbour.com/best-a-b-testing-tools/>)

Media Attributions

- A/B testing overview (<https://technofaq.org/posts/2017/03/heres-how-you-should-approach-ab-testing-for-marketing/>) by guest author on Techno FAQ (<https://technofaq.org/>) is licensed under a CC BY-NC-SA 4.0 licence.
- What is A/B Testing? | Data Science in Minutes (<https://youtu.be/zFMgpxG-chM>) by Data Science Dojo (<https://www.youtube.com/@Datasciencedojo>) is licensed under a Standard YouTube License.
- Multivariate A/B tests (<https://devopedia.org/a-b-testing>) by Navot is licensed under a CC BY-SA 4.0 licence.
- Google Optimize Tutorial (<https://www.youtube.com/watch?v=6RMpCNrc7Ds>) by Loves Data (<https://www.youtube.com/@LovesData>) is licensed under a Standard YouTube License.
- What is personalization? (https://www.youtube.com/watch?v=U39SZCB_i9w) by Kameleoon (<https://www.youtube.com/@kameleoon17>) is licensed under a Standard YouTube License.

17.

Attribution

Learning Objectives

By the end of this chapter, you should be able to.

- **Explain** what marketing attribution is and how to use it
- **Describe** several marketing attribution approaches
- **List** the required steps to develop a marketing attribution model
- **Name** several online tools that provide marketing attribution

Marketing Attribution

Marketing attribution is the practice of evaluating the marketing touch points a customer encounters on their path to a desired marketing outcome. A desired outcome is often a purchase but could also include other outcomes and actions such as a signing up for an email newsletter sign-up, downloading a research paper, booking a demo, etc. The goal of attribution is to determine which marketing channels and messages have had the greatest impact on a customer's decision to convert or take the desired next step. Once marketers understand which channels and messages are most successful, they can optimize their efforts and budgets.

To make this clear, let's walk through a fictitious scenario.

Attribution Scenario

Let's assume that a customer was exposed to several marketing campaigns and marketing messages across a variety of marketing channels, such as:

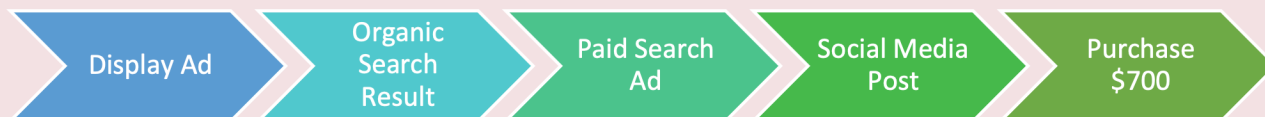

In the simplified customer journey above, we see that a customer made a \$700 purchase after seeing:

- a display ad,

- an organic search result,
- a paid ad, and
- a social media post.

Now, the question comes up, **to which channel or activity do we attribute this \$700 purchase?** Or, how much of that \$700 do we credit to *each* marketing activity, campaign, or touchpoint?

Unfortunately, even with our current digital marketing analytics systems, it is difficult to *precisely* answer these questions. However, there are a few common industry models and practices that marketers can use to approximate the contributions these campaigns made to the ultimate purchases or conversions:

- **First or last touch attribution**
- **Even (linear) attribution**
- **Time decay attribution**
- **Starter / Player / Closer / “U” attribution**
- **Custom attribution**

Let’s take a closer look at each of these different attribution approaches.

First or Last Touch (or Interaction) Attribution

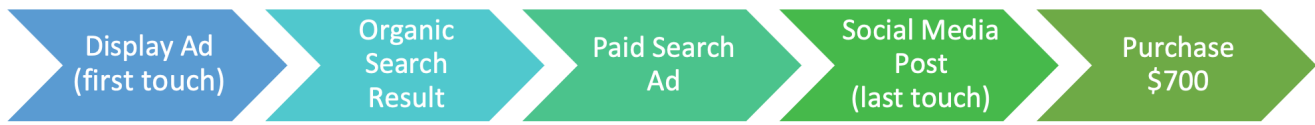

First touch attribution gives full credit to the **first** touchpoint in the customer journey. In the above scenario, this would mean that the marketer would credit their “Display Ad” campaign with the entire \$700 purchase amount.

Similarly, **last touch attribution** gives full credit to the **last** touchpoint in the customer journey. In our scenario, that would give “Social Media” full credit for the \$700 purchase.

The main benefit of this model is that it is simple to calculate and track. That said, it under represents the branding, influence, and sales effects the other campaigns may have had in convincing that customer to purchase.

Now, let’s practice ...

H5P: First Touch Marketing Attribution Model

A customer has made a purchase for \$625.

Drag the proper amounts from the various marketing channels below into the appropriate “Attribution Spot” to the reflect a *first touch attribution model*.

Attribution Spot #1	Attribution Spot #2	Attribution Spot #3	Attribution Spot #4	Attribution Spot #5
<ul style="list-style-type: none"> • Social Media – \$0 • Display Ad – \$75 • Paid Ads – \$625 • Organic Search – \$200 		<ul style="list-style-type: none"> • Display Add – \$125 • Display Ad – \$0 • Organic Search – \$75 • Email – \$0 		<ul style="list-style-type: none"> • Paid Ads – \$0 • Email – \$75 • Organic Search – \$0 • Social Media – \$125

H5P: Last Touch Marketing Attribution Model

A customer has made a purchase for \$625.

Drag the proper amounts from the various marketing channels below into the appropriate “Attribution Spot” to reflect a *last touch attribution model*.

Attribution Spot #1	Attribution Spot #2	Attribution Spot #3	Attribution Spot #4	Attribution Spot #5
<ul style="list-style-type: none"> • Social Media – \$0 • Display Ad – \$75 • Paid Ads – \$75 • Organic Search – \$200 		<ul style="list-style-type: none"> • Display Ad – \$125 • Display Ad – \$0 • Organic Search – \$625 • Email – \$0 		<ul style="list-style-type: none"> • Paid Ads – \$0 • Email – \$75 • Social Media – \$125 • Organic Search – \$0

Even (Linear) Attribution

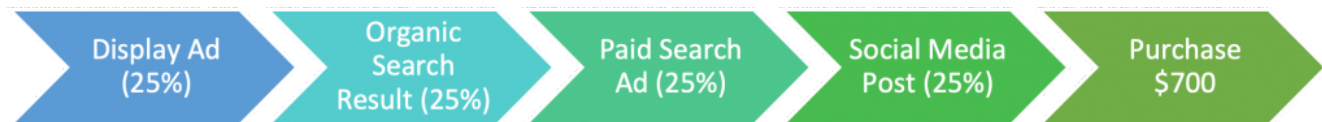

Even (linear) attribution recognizes that each touchpoint plays a part in the customer’s purchase decision and therefore, distributes the \$700 equally across all the touchpoints. So, in our scenario, *each* marketing activity / campaign would be credited with \$175 (= \$700 ÷ 4) – display ad, organic search, paid ad, and social media. Once again, the main benefit of this model is that it is simple to calculate. However, when we think about our own purchasing habits, we know that each marketing message does not carry the same weight. For example, more recent marketing messages and campaigns, i.e., closer to the purchase date, may have more influence in converting the customer, which brings us to the next attribution model.

Once again, let’s assign a linear attribution model to the following scenario:

H5P: Linear Marketing Attribution Model

A customer has made a purchase for \$625.

Drag the proper amounts from the various marketing channels below into the appropriate “Attribution Spot” to the reflect a *linear attribution model*.

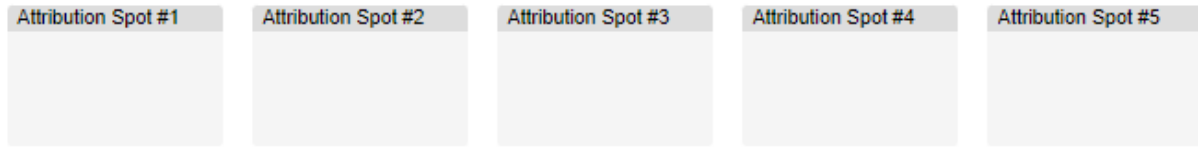

- Social Media – \$175
- Display Ad – \$175
- Paid Ads – \$175
- Organic Search – \$75
- Display Ad – \$125
- Display Ad – \$75
- Organic Search – \$175
- Email – \$125
- Paid Ads – \$175
- Email – \$175
- Organic Search – \$125
- Social Media – \$125

Time Decay Attribution

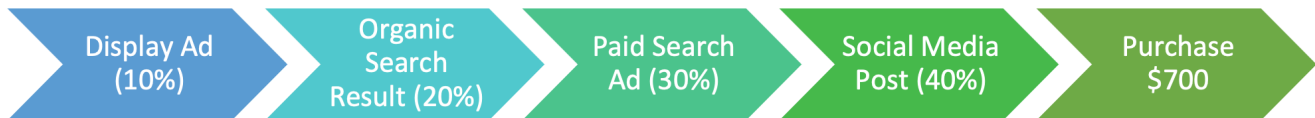

Time decay attribution gives the lowest percent of credit to the first touch, with increasing values as you move towards the last touch. For example, in the image above, the marketer has decided to credit display ads with 10% of the purchase amount (\$70), organic search with 20% (\$140), paid ads with 30% (\$210) and social media with 40% (\$280). Please note that these percentages are only examples. Another marketer in a *different* organization may choose to split up their purchase amounts differently, e.g., 5%, 15%, 30%, 50%. This simply means that the time decay model you use within your organization can be customized to best approximate what is happening with **your** customer journeys.

Let’s give time decay attribution a try ...

H5P: Time Decay Marketing Attribution Model

A customer has made a purchase for \$625.

Drag the proper amounts from the various marketing channels below into the appropriate “Attribution Spot” to the reflect a *time decay attribution model*.

- Social Media – \$200
- Display Ad – \$175
- Paid Ads – \$50
- Organic Search – \$75
- Display Ad – \$125
- Display Ad – \$0
- Organic Search – \$175
- Email – \$125
- Paid Ads – \$75
- Email – \$200
- Organic Search – \$125
- Social Media – \$175

Starter / Player / Closer / Position-based / “U” Attribution

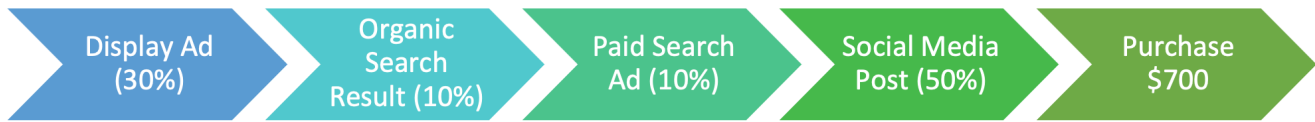

The final model assigns different percentages depending on where the touchpoint is in the customer journey. The **starter (initiating) touch** receives a set percent of credit for the conversion. Usually, this is relatively high since the initiating touch makes the customer aware of your brand and offering. In other words, without this starter touch, there would not even be a purchase. The **closer (last) touch** also receives a set percentage of credit for the conversion. And, again, this percentage is somewhat higher because it is the final “trigger” that got the customer to purchase. **Player touches** are those touches in the middle of the customer journey, and each receive a percentage of the remaining credit for the conversion. While player touches have not initiated the action, they do contribute to keeping your brand alive in the mind of the customer and should therefore receive some credit for that role.

In our scenario above, display ad and social media get credit for a total of 80% of the purchase amount and the remaining two campaigns get 10% each. Sometimes this model is referred to as a “**U**” **attribution** because the starter and closer touchpoints receive higher percentages than the player touchpoints in the middle. So, the percentage amounts look a bit like a “U”. Once again, these percentages are just examples. As a marketer, you can decide how best to distribute the purchase amounts across your marketing activities and touchpoints.

As you can see, there is not one specific way to attribute credit for a conversion. That said, what is critical is to be consistent and use the same model for all conversions within your customer journey. This means using the same model for all your marketing attribution calculations. While the specific model may not be 100% accurate, all marketing activities will be evaluated similarly. And, when a model is applied consistently, you can ultimately compare and analyze the effectiveness of your marketing campaigns and activities against each other.

Let’s practice this once again:

H5P: Starter / Player / Closer / Position-based / “U” Marketing Attribution Model

A customer has made a purchase for \$625.

Drag the proper amounts from the various marketing channels below to the *reflect a starter / player / closer / position-based / “U” attribution model*.

- Social Media – \$225
- Display Ad – \$75
- Paid Ads – \$50
- Organic Search – \$75
- Display Ad – \$125
- Display Ad – \$50
- Organic Search – \$175
- Email – \$200
- Paid Ads – \$200
- Email – \$175
- Organic Search – \$125
- Social Media – \$175

Custom Attribution

Depending on your organization, you may want to consider creating a “custom attribution” model. This model may be a hybrid of the previously mentioned models or it may be a model that you develop from scratch. Please note that building a marketing attribution model from scratch requires a significant amount of resources and time. So, you want to make sure that it will be worth your investment.

You should build a custom attribution model if you:

- Have a large marketing team and access to more resources
- Use multiple online and offline marketing channels
- Previously tried one or more standard marketing attribution models without success
- Need to provide stakeholders with a more comprehensive or detailed report

If you are interested in delving deeper into attribution models, here is a 39-minute video, **Attribution Modeling – An In-Depth Guide** (<https://youtu.be/Cr8UQXIcQ50>), that covers many more details about attribution modelling so you can become an attribution master. The video covers:

- Facebook ads attribution modeling
- Google ads attribution modeling
- Marketing attribution modeling
- Data-driven attribution model
- Attribution modeling google analytics
- Attribution model for Google Ads
- Multi-touch attribution modelling and more.



One or more interactive elements has been excluded from this version of the text. You can view them online here: <https://opentextbc.ca/foundationdigitalmarketing/?p=134#oembed-1> (#oembed-1)

How to Build an Attribution Model

Now, that you know what attribution model options are available to you. How do you build one for your organization? Here are 5 steps that will help you identify and develop an appropriate attribution model:



1. **Conduct a Marketing Channel / Touchpoint Audit**

As discussed in the **customer journey chapter**, customer journeys should document all the marketing channels and touchpoints your potential and existing customers encounter. Performing a formal audit, where you list and identify all the potential touchpoints that apply to your specific product or service, is an important starting point. You may want to do this with an expanded team via a brainstorming session to ensure you get a variety of perspectives and ideas. And, you should also note that there may be different customer journeys for different products or services within the same organization. Do make sure the customer journey you are reviewing applies to the products or services you want to analyze.

2. **Set Clear Goals**

One of the reasons to create attribution models is to ensure your marketing efforts are delivering the results needed by your organization. Without clear goals and targets, it is difficult to assess how well your marketing efforts are doing. So, it is critical to set specific goals and expectations for the marketing team.

3. **Map Your Customer Journey**

In mapping your customer journey, you can see which channels and campaigns you will be monitoring. And, when you analyze the customer journey, you will be able to assess which touchpoints have more impact and should be weighted accordingly.

4. **Score Your Leads and Prospects**

Lead scoring will help you identify which leads are more likely to convert, as well as which ones may need additional convincing and messaging to convert.

5. **Invest in the Right Attribution Tools**

Tracking and monitoring the information for every touchpoint manually can be extremely

tedious and taxing. And, unfortunately, it is likely to introduce mistakes. Using a industry-standard, customer relationship management (CRM) systems makes it easier to track and automate your attribution model analyses. It also allows you to collect data across multiple advertising and marketing campaign networks throughout your customer journey and to create dashboards and reports of all essential performance metrics.

Marketing Attribution Tools

Benefits of Marketing Attribution Tools

If you are tracking your conversions using Google Analytics, the following tools can help. There are some key advantages to automated marketing attribution solutions. Below are 3 common benefits:

- **Better understand what is working and what is not**
Marketing attribution tools can help you quickly recognize your most reliable advertising and marketing channels. When evaluating your spending budgets, you will be able to invest even more resources into those networks that have the most influence and decrease spending on those that are not delivering results.
- **Discover the number of touches your leads need before converting**
If you just released a new ad campaign or released a brand new piece of content, it can be discouraging if you do not see conversions happen immediately. Marketing attribution tools can help you prove the ROI of your activities at the beginning or middle of a customer journey.
- **Get data-driven insights to enhance marketing activities**
With marketing attribution tools, you can expose which lead generation methods are having the best impact on your ROI and also allocate your spending plan accordingly.

Some marketing attribution applications can also assist with inquiries often asked by executives and clients, such as:

- How does marketing help bring in clients?
- How can we drive more sales with our marketing?
- Which campaigns are most or least effective in converting customers?
- What is my return on investment on the XYZ project?
- Which marketing activities drive the highest customer lifetime value?
- Where should we be investing our money?

List of Marketing Attribution Tools

The following list of marketing attribution tools offer either a free version or are inexpensive:

- **Google Attribution Model** (https://www.google.com/analytics/attribution/onboarding?utm_source=foundationsindigitalmarketing)
Use Google's advanced machine learning to more accurately distribute credit to all ad clicks that led to a conversion. This service is available to all eligible Google advertisers for free.
- **Google Analytics** (<https://analytics.google.com/analytics/web/>)

provision/#!/provision?utm_source=foundationsindigitalmarketing)

Google Analytics works with its own advertising and publishing products to tell marketers how its products are performing.

- **Ruler Analytics**

- (https://www.ruleranalytics.com/?utm_source=foundationsindigitalmarketing)

- Ruler Analytics is a closed-loop multi-channel attribution tool that helps marketers gain insight into their marketing ROI.

- **HubSpot** (https://www.hubspot.com/?utm_source=foundationsindigitalmarketing)

- Marketing attribution is a part of the HubSpot CRM platform, which is full of many tools and integrations – from customer service assistance to website building.

- **AppsFlyer** (https://www.appsflyer.com/?utm_source=foundationsindigitalmarketing) (Mobile Apps)

- AppsFlyer focuses on attribution for mobile app installs and the media sources that drove them, e.g., TV, as well as uninstall attribution (customers lost).

- **Chartable** (https://chartable.com/?utm_source=foundationsindigitalmarketing) (Podcasts)

- Chartable provides podcast analytics and attribution tools to help publishers grow and brands and agencies understand their spend.

For an even more comprehensive list, please check out this **List of 36 Marketing Attribution Services** (<https://leadsrx.com/blog/35-marketing-attribution-software-companies>).

Key Takeaways

- Marketing attribution is the practice of evaluating the marketing touch points a customer encounters on their path to a desired marketing outcome.
- While purchases are the most common type of a desired outcome (also called conversions), there are many other conversions that marketers may monitor, e.g., signing up for a newsletter, downloading content, or booking a demo.
- Marketing attribution is key to understanding which marketing channels and activities are performing best. There are many different attribution models and each one has advantages and disadvantages. The most common attribution models are the following
 - First or last touch attribution
 - Even (linear) attribution
 - Time decay attribution
 - Starter / Player / Closer / “U” attribution
 - Custom attribution
- Marketers can build their own attribution model using the following 5-step process:
 1. Conduct a Marketing Channel / Touchpoint Audit
 2. Set Clear Goals
 3. Map Your Customer Journey
 4. Score Your Leads and Prospects
 5. Invest in the Right Attribution Tools

- While the various attribution models may not be 100% accurate in representing the **actual** weighting of the marketing channels / activities, it is critical that marketers be consistent and use the same model to better compare and analyze the effectiveness of their marketing campaigns and activities against each other.
- There are several marketing attribution tools available to help automate the attribution process, e.g.:
 - **Google Attribution Model** (https://www.google.com/analytics/attribution/onboarding?utm_source=foundationsindigitalmarketing)
 - **Google Analytics** (https://analytics.google.com/analytics/web/provision/#/provision?utm_source=foundationsindigitalmarketing)
 - **Ruler Analytics** (https://www.ruleranalytics.com/?utm_source=foundationsindigitalmarketing)
 - **HubSpot** (https://www.hubspot.com/?utm_source=foundationsindigitalmarketing)
 - **AppsFlyer** (https://www.appsflyer.com/?utm_source=foundationsindigitalmarketing) (Mobile Apps)
 - **Chartable** (https://chartable.com/?utm_source=foundationsindigitalmarketing) (Podcasts)

Attribution – Discussion Questions & Additional Resources

Discussion Questions

- Given the nature of current attribution models, how might we improve our accuracy? Are there any technologies that could improve our visibility into our customers' activities?
- If we could track customers more accurately, how might this impact our privacy? And, personally, is this something you would be okay with?

Additional Resources

- Bizible's Marketing Attribution 101 eBook (<https://info.bizible.com/intro-guide-b2b-marketing-attribution>)
- Attribution Models for Marketers: The Definitive Guide (<https://agencyanalytics.com/blog/marketing-attribution-models>)

Media Attributions

- Marketing attribution example by Rochelle Grayson is licensed under a CC BY 4.0 licence.
- First or last touch attribution by Rochelle Grayson is licensed under a CC BY 4.0 licence.
- Even or linear attribution by Rochelle Grayson is licensed under a CC BY 4.0 licence.
- Starter – Player – Closer – “U” Attribution by Rochelle Grayson is licensed under a CC BY 4.0 licence.
- Time decay attribution by Rochelle Grayson is licensed under a CC BY 4.0 licence.
- Attribution Modeling – An In-Depth Guide (<https://www.youtube.com/watch?v=Cr8UQXIcQ50>) by Humanlytics (<https://www.youtube.com/@humanlytics3533>) is licensed under a Standard YouTube License.
- Creating an attribution model by Rochelle Grayson is licensed under a CC BY 4.0 licence.

18.

Conversion Rate Optimization

Learning Objectives

By the end of this chapter, you should be able to:

- **Explain** the relationship between conversion rate optimization (CRO) and customer journeys
- **Describe** the key areas affecting CRO

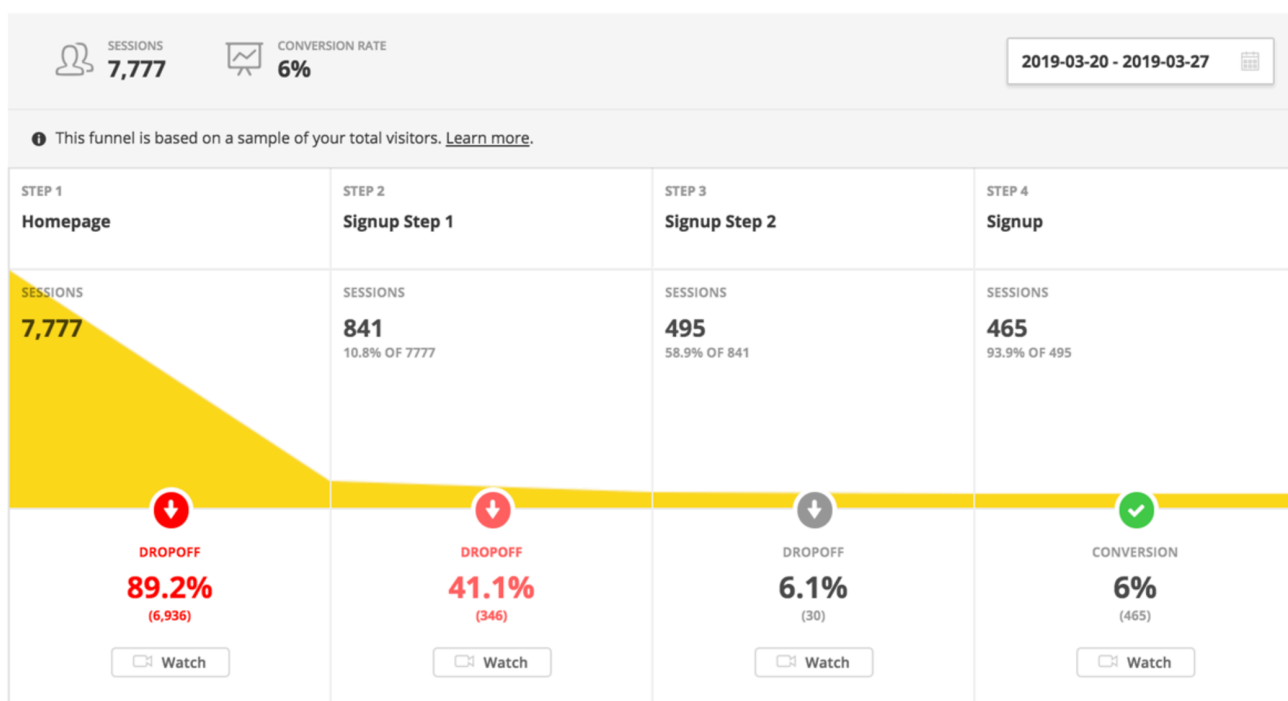

A/B Testing is a subset of conversion rate optimization. **Conversion rate optimization (CRO)** is the practice of increasing the percentage of users who perform a desired action. Desired actions can include:

- Purchasing a product or service,
- Clicking ‘add to cart’,
- Signing up for a service or newsletter,
- Filling out a form, or

- Simply clicking on a link.

While A/B testing looks to optimize specific marketing campaigns or activities, conversion rate optimization looks at the entire customer journey and tries to identify areas along the customer journey where optimization can happen.

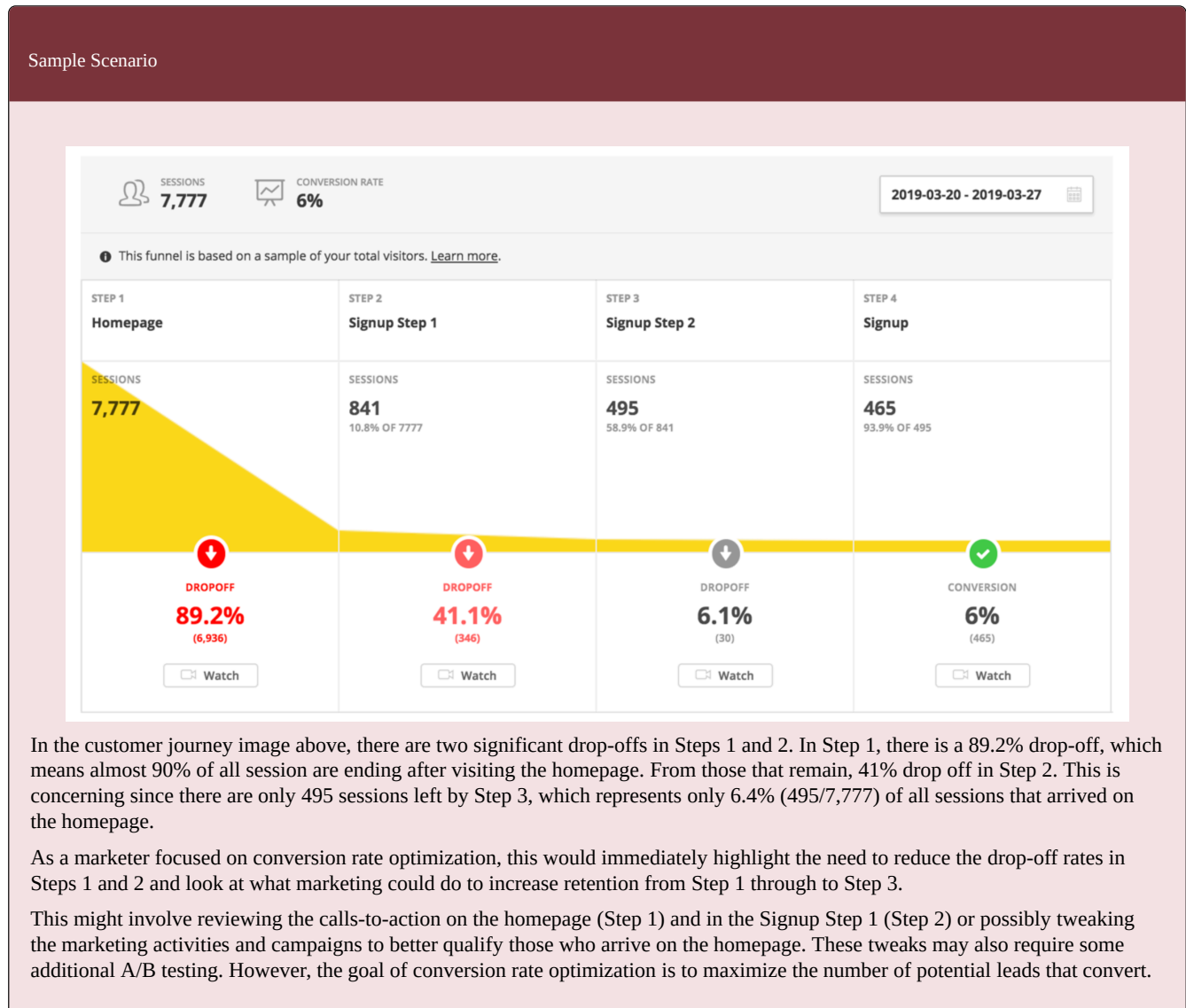

Generally speaking, there are four key areas that marketers will analyze when engaging in CRO:

- **Target Audience**

Sometimes the reason for a lack of conversion is that the **target audience** is not the appropriate one. For example, if you drive lots of traffic to your website via a marketing campaign, but the visitors who end up on your website are not the type of customers interested in your solutions, your conversions may be low.

- **Content**

Alternatively, or maybe additionally, if the content you present does not meet the needs of your target audience, you may see drop-offs, as well. In this case, you may want to conduct

some A/B tests to compare different **content options**.

- **Landing Pages**

As discussed in the **Landing Pages** chapter, ensure that your landing pages include:

- **Unique selling propositions**
What is unique about your offer?
- **Specific customer benefits**
Be sure to include the actual benefits to your target audience not just your product or service features.
- **Clear calls-to-action**
Do your calls-to-action create urgency?
- **Appropriate visuals / imagery**
Do your visuals support your calls-to-actions, unique selling proposition, and customer benefits? And, if visitors have landed on this page based on an advertisement, make sure that the visuals and content match those in the ad, i.e., what the visitors expect to see and read when they land on your page.
- **Social proof and credibility elements**
These elements reassure your visitors of your organizational authority and credibility. This might include testimonials, previous client logos, case studies, etc.

Again, in closely reviewing all the above elements, you may choose to conduct A/B tests to better understand which element changes result in higher conversions. For more on high-converting landing pages, here's a 6.5-minute video, **The Anatomy Of A High Converting Landing Page** (<https://youtu.be/hcPxMuxh5Tc>)



One or more interactive elements has been excluded from this version of the text. You can view them online here: <https://opentextbc.ca/foundationdigitalmarketing/?p=137#oembed-1> (#oembed-1)

- **Budget**

And, finally, if you are using paid advertising to drive your traffic, your budgets or bidding strategy may not be appropriate for the goals and objectives you seek. Once again, you can experiment with bidding strategies or increase your budget to see if that impacts your overall conversion funnel and attracts your target audience.

Remember our conversion funnel from the **customer journey** chapter?

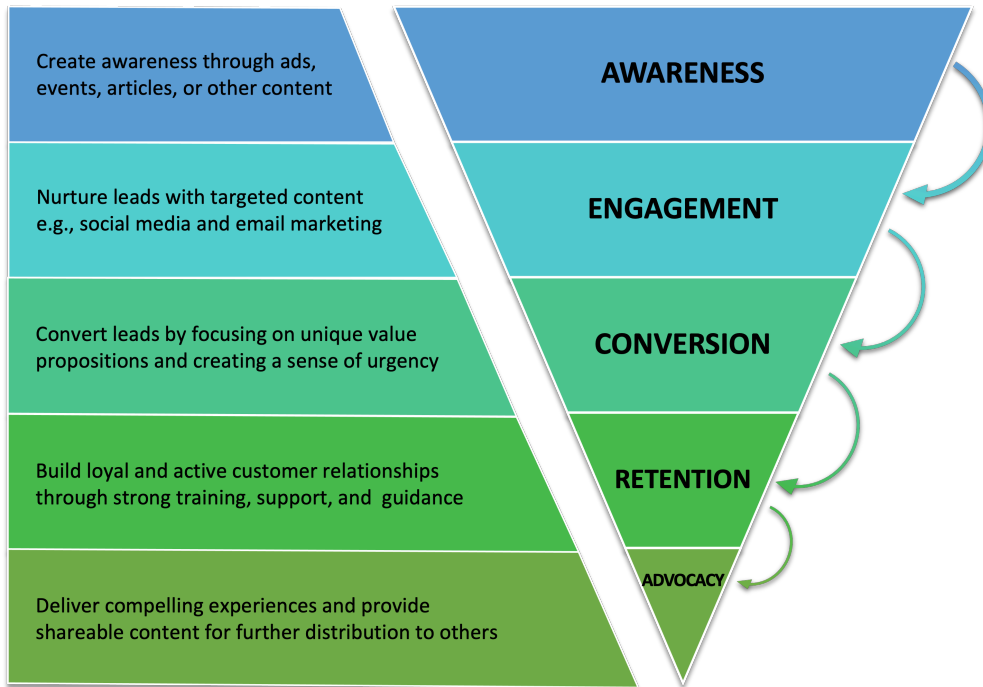

Let’s now review some results from a fictitious hotel and explore how we might optimize those activities:



An interactive H5P element has been excluded from this version of the text. You can view it online here: <https://opentextbc.ca/foundationdigitalmarketing/?p=137#h5p-18> (<https://opentextbc.ca/foundationdigitalmarketing/?p=137#h5p-18>)

H5P: Conversion Funnel Calculation & Optimization Exercises

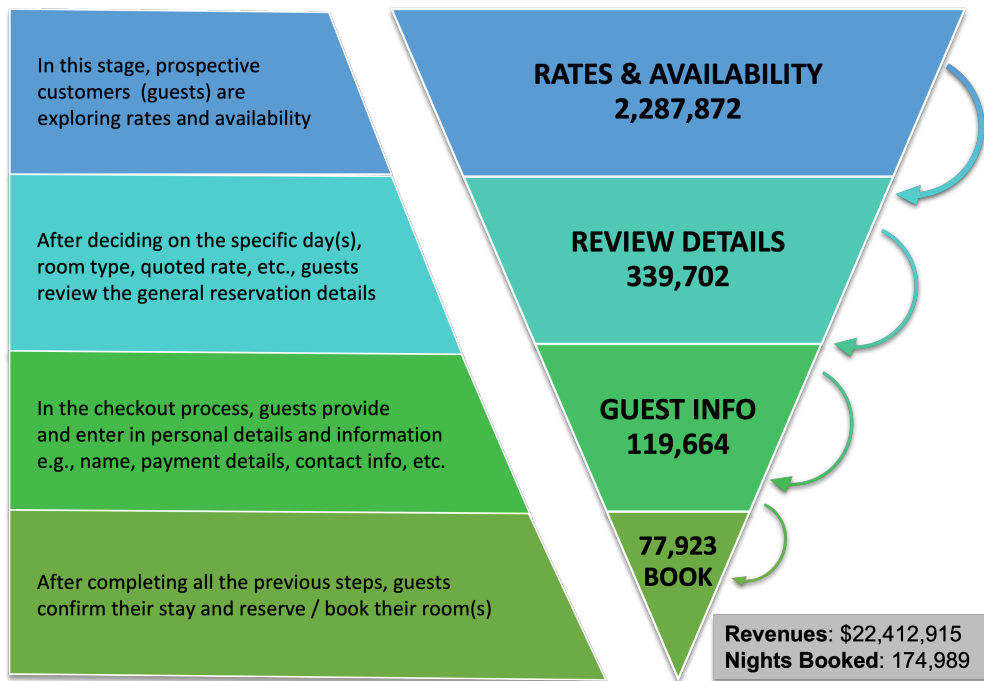

- In each of the above stages, the numbers presented show how many (potential) guests participated in those activities related to that stage. Given the above conversion funnel, **what was this hotel's conversion rate?**
 - 14.8%
 - 65.1%
 - 29.4%
 - 3.4%
- A **micro-conversion rate** is the conversion rate between funnel stages. Which of the following options represents the **correct micro-conversion rates for the hotel?**
 - Review Details: 14.8%
Guest Info: 35.2%
Booked: 65.1%
 - Review Details: 6.7%
Guest Info: 2.8%
Booked: 1.5%
 - Review Details: 14.8%
Guest Info: 5.2%
Booked: 3.4%
 - Review Details: 29.3%
Guest Info: 4.4%
Booked: 1.5%
- If the total number of nights booked (for all reservations) was 174,989 nights, **what is the average number of nights per booking / reservation?**
 - 2.25
 - 13.1
 - 0.76

- d. 0.45
4. Given that total revenues (for all the reservations) was \$22,412,915, what is the average revenue per booking?
- a. \$347.67
 - b. \$9.79
 - c. \$10.21
 - d. \$287.63
5. Now, that you understand the basic funnel calculations, let's look at some optimization scenarios ...
The current total revenues are \$22,412,915. If traffic increased by 10%, **how much total revenue would there be? And, how many more conversions would result?**
- a. **Revenues:** \$24,654,206.50 **Conversions:** 85,715
 - b. **Revenues:** \$2,241,291.50 **Conversions:** 85,715
 - c. **Revenues:** \$24,654,206.50 **Conversions:** 7,792
 - d. **Revenues:** \$2,241,291.50 **Conversions:** 7,792
6. And, here's a slightly more complicated optimization scenario ...
If you could increase the percentage of people who arrive at the Review Details step by 20%, what would the conversion rate be?
- a. 4.1%
 - b. 19.1%
 - c. 78.1%
 - d. 3.4%

Conversion rate optimization takes a macro view of your customer journey and where appropriate will drill down and use A/B testing to better understand what needs to be improved and updated. For more details, review this article, **Conversion Optimization Made Simple: A Step-by-Step Guide by Neil Patel** (<https://neilpatel.com/what-is-conversion-optimization/>).

As you can see, there may be many ways to optimize your conversion funnel. As a result, there are also a variety of tools you can use. The tool you require will depend on the area you need to optimize. Here's a great article that lists **34 CRO tools** (<https://www.convertize.com/cro-tools/>) split up into the following categories:

- **Analyzing Your Conversion Funnel** (<https://www.convertize.com/cro-tools/#funnel-analysis-tools>)
- **Testing Your Website / Webpage Loading Speed** (<https://www.convertize.com/cro-tools/#website-speed-tools>)
- **Studying and Mapping User Behaviour** (<https://www.convertize.com/cro-tools/#user-behaviour-tools>)
- **Surveying Your Customers** (<https://www.convertize.com/cro-tools/#survey-tools>)
- **Creating High-Converting Landing Pages** (<https://www.convertize.com/cro-tools/#landing-page-tools>)

- **A/B Testing Your Content** (<https://www.convertize.com/cro-tools/#ab-testing-tools>)
- **Starting to Talk To Visitors** (<https://www.convertize.com/cro-tools/#customer-chat-tools>)
- **Creating Social Proof** (<https://www.convertize.com/cro-tools/#nudge-notifications>)

Some of the tools will be the same **A/B testing tools** in the previous topic. However, others augment and complement those tools and can provide you with additional data and insights around your conversion funnel and optimization opportunities.

Key Takeaways

- Conversion rate optimization looks at the entire customer journey and tries to identify areas along the customer journey where optimization can happen.
- There are four key areas that marketers will analyze when engaging in CRO:
 - Target Audiences
 - Content
 - Landing / Webpages
 - (Spending) Budgets

Conversion Rate Optimization – Additional Resources

For more details on conversion rate optimization, please review the following articles:

- Conversion Rate Optimization (CRO): 8 Ways To Get Started (<https://blog.hubspot.com/marketing/conversion-rate-optimization-guide>)
- Conversion Rate Optimization When You Don't Have Much Traffic (<https://moz.com/ugc/how-to-do-conversion-rate-optimization-when-you-dont-have-much-traffic>)
- Conversion Rate Optimization (<https://moz.com/learn/seo/conversion-rate-optimization>) (+ *Recommended Tools*)
- 53 Conversion Rate Optimization Tools: Comprehensive Guide (<https://research.aimultiple.com/conversion-rate-optimization-tools/>)

Media Attribution

- An example of funnel visualization (https://en.wikipedia.org/wiki/Funnel_analysis#/media/File:Funnel-analysis-example.png) by Hoppertron is licensed under a CC BY-SA 4.0 licence (<http://creativecommons.org/licenses/by-sa/4.0/>).
- The Anatomy Of A High Converting Landing Page | Conversion Rate Optimization Tips (<https://www.youtube.com/watch?v=hcPxMuxh5Tc>) by Neil Patel (<https://www.youtube.com/@neilpatel>) is licensed under a Standard YouTube License.
- Conversion funnel with descriptions by Rochelle Grayson is licensed under a CC BY 4.0 licence.

19.

Digital Marketing Analytics and Calculations

Learning Objectives

By the end of this chapter, you should be able to:

- **Describe** several common digital marketing KPIs and their purpose
- **Calculate** return on investment (ROI) and return on ad spend (ROAS)
- **Explain** ways to track your digital marketing activities
- **List** several analytics tools for tracking marketing activities

Common Digital Marketing KPIs



In the **Lead Generation** chapter, we discussed the importance of setting your goals and objectives, for example:

- **Primary conversions**
 - Purchase
 - Donate
- **Secondary conversions**

- Sign up / provide contact information for:
 - Free or Limited Trial
 - Webinar / Demo
 - Newsletter
 - Downloadable content, e.g., whitepapers, research, etc.
- **Tertiary goal** (*not a conversion!*)
 - Brand awareness and exposure
- **Specific KPIs and Targets**

Setting specific and measurable key performance indicators (KPIs) and targets for your marketing activities. For example, how many purchases do you want to get? Or how many people do you want to sign up for your newsletter or to attend your webinar?

When it comes to digital marketing analytics, the most frequently asked question by marketers is: **which KPIs, analytics, metrics should I be monitoring?** While this chapter will review several common digital marketing KPIs, each organization will have different goals and objectives. So, the most important analytics to monitor and capture will be those that help measure, meet, and exceed your organizational goals and objectives. That said, in this chapter, we will review:

- The purpose of several common marketing KPIs,
- How these metrics are calculated, and
- What these marketing KPIs signify.

However, before diving into what marketers may want to monitor or track, let's briefly discuss vanity metrics. **Vanity metrics** are those metrics that do NOT:

- Impact your bottom line
- Increase revenues
- Decrease costs

In other words, vanity metrics are metrics that you cannot act on or affect. Often marketers will track metrics because they are easy to capture or are simply available. But if an organization cannot connect those metrics, directly or indirectly, to increases in the organization's overall performance, those analytics should not be followed. In some marketing cases, like brand awareness, the connection may be indirect, e.g., by increasing brand awareness, the likelihood of conversion also increases; but there may be difficulty in tying brand awareness directly to increased revenues or decreased costs. Indirect connections are fine; they simply need to be understood and explained.

Ideally, digital marketers will want to quantify how an increase in brand awareness translates to better performance. For example, for every X number of people who become aware of our product and/or services, Y number of new customers convert. Most organizations are not at this stage, but once marketers start closely tracking their data and analytics, these connections and models can be developed over time.

Now that we know which KPIs not to monitor, which KPIs do most marketers track? Here are some of the most common KPIs split into a few categories:

General Marketing & Revenue KPIs

General marketing KPIs are KPIs that should be tracked by all marketers. These analytics provide valuable customer and revenue feedback that influence marketing budgets, activities, and performance.

- **Customer Acquisition Cost (CAC)**

Customer acquisition cost represents how much is spent to acquire a new customer. This KPI is important in comparison to how much revenue is being generated by new customer. For example, if an organization knows that it receives, on average, \$150 from a new customer and marketing / sales is spending, on average, \$175 to advertise, promote, and convert a new customer, the organization is losing \$25 on that new customer when the customer initially signs up. For the sake of this example, we have only looked at the marketing / sales costs, but to fully calculate the total Customer Acquisition Cost, an organization might add in other costs. However, for marketing and sales, here is the most common way to calculate this number:

- **Customer Acquisition Cost – Calculation**

= (All Sales Expenses + All Marketing Expenses in the Period, e.g., month, quarter, etc.) / Number of New Customers in the Period

- **Customer Lifetime Value (LTV or CLTV)**

While an organization may lose money when a customer initially signs up, that may be marginally okay if an organization calculates this next metric, the customer lifetime value. The **customer lifetime value** calculates, on average, the total amount of revenue an organization will generate from a customer over time. Returning to our previous example, if the organization recognizes that the average customer lifetime value is \$275, it can make up that initial \$25 loss in subsequent months, years, etc.

A simple way to calculate this is to take the average monthly revenue per user (customer) and divide that by the average monthly churn rate. The monthly churn rate is the number of customers who have “left” by the end of the month divided by the number of customers at the beginning of the month. Suppose you had 200 customers at the beginning of the month and 150 customers at the end of the month. Your churn rate would be: $\text{churn rate (\%)} = (200 - 150) / 200 = 50 / 200 = 0.25$, or 25%. And, if your Average Monthly Revenue per User was \$125, your estimated customer lifetime value would be $\$125 / 0.25 = \500 . There are some more detailed ways to calculate this metric and if you are interested, here is an article that outlines 5 Simple Ways to Calculate Customer Lifetime Value.¹

- **Customer Lifetime Value – Simple Calculation**

= Average Revenue per User (ARPU) in the Period / Churn Rate in the Period

- **LTV to CAC Ratio (Return on CAC)**

Now that we have calculated the customer acquisition cost and customer lifetime value, it can

1. 5 Simple Ways to Calculate Customer Lifetime Value (<https://medium.com/swlh/5-simple-ways-to-calculate-customer-lifetime-value-5f49b1a12723>)

be helpful to look the ratio of the two. This helps an organization understand their return on customer acquisition costs. In other words, how much revenue will an organization generate from a customer for every \$1 spent to acquire them. For example, software-as-a-service (SaaS) companies generally aim to have an LTV to CAC ration that is higher than three (3), meaning the customer lifetime value of a customer is at least three times (3x) that of the cost to acquire them. Another way to look at this is that for every dollar spent on customer acquisition those companies receive \$3 in revenues (3:1 LTV to CAC ratio).

- **LTV to CAC Ratio – Calculation**
= LTV / CAC

Example

In the following example, an organization split up the LTV and CAC values by paid advertising channel. At first glance, it might appear that LinkedIn is the best marketing channel given that it has the highest customer lifetime value (LTV). However, when considering the customer acquisition costs (CAC) and calculating the LTV to CAC ratio, marketers can quickly see that, in fact, Retargeting provides the highest ROI because the LTV to CAC ratio is 3.69:

Customer Lifetime Value (LTV) to Customer Acquisition Costs (CAC) Ratio for Different Channels

Channel	LTV	CAC	Ratio
Paid LinkedIn	\$1,267	\$491	2.58
Paid Facebook	\$831	\$534	1.56
Paid Google	\$1,154	\$397	2.91
Retargeting	\$886	\$240	3.69

As a result of this analysis, marketers can adapt future paid advertising activities and allocate their budgets accordingly.

- **Conversion Rate**

As alluded to in the **Email** chapter, conversion rate refers to the number of people who complete a desired conversion (primary or secondary) out of the “total audience” that was exposed to that opportunity / possible action. For example, for email, the audience could be the total number of delivered or opened emails; for a website, the audience would be the total number of website visitors over a specified time. On social media, the total audience could be the reach or total views for a specific post. Using the website example, conversion rate would be calculated as follows:

- **Conversion Rate – Calculation**
= Number of Visitors Who Converted in the Period / Total Website Visitors in the Period x 100

- **Revenue per Visitor (RPV)**

Revenue per visitor represents the average amount of revenue generated for every visitor. This KPIs is interesting because it ties visitor traffic directly to revenues. So, if a marketer can show that a specific campaign increased website traffic by 5%, they should be able to

calculate a specific \$-increase related to that additional traffic.

Example

Suppose an organization had a revenue per visitor value of \$1.50 in Month 1. Then, after a marketing campaign, the website saw an increase of 10,000 additional website visitors (compared to the previous month). Based on these two numbers, the marketer could argue that the campaign brought in $10,000 \times \$1.50 = \$15,000$ in additional revenues, provided the revenues per visitor remained the same for Month 2. If the RPV in Month 2 increased to \$1.75, this increase in traffic would represent $10,000 \times \$1.75 = \$17,500$. In addition to the increase in traffic and revenues, a marketer might also argue that the additional, new visitors helped and contributed to the raise in the Month 2 RPV value from \$1.50 to \$1.75.

Another reason RPV is significant is because it represents the most a marketer should spend to acquire a visitor, without losing money. In other words, if a marketer were bidding on paid advertising, the RPV value would represent the maximum CPC they would be willing to pay to avoid an initial customer acquisition cost (CAC) loss. Once again, if the organization believes that it can recover a loss based on the customer lifetime value, marketers may be able to bid higher. However, as a rule of thumb, it is recommended to use RPV as a bidding ceiling.

- **Revenue per Visitor (RPV) – Calculation**
= Revenue in the Period / Visitors in the Period

- **Monthly Recurring Revenue (MRR) Churn Rate**

With more companies offering monthly subscription payment plans, there is a lot of discussion about monthly recurring revenue (MRR) and similarly the MRR churn rate. The MRR churn rate highlights the percentage decrease in MRR from one month to the next. In other words, compared to the previous month's MRR, what percentage of MRR was lost due to customers leaving in the current month?

- **Monthly Recurring Revenue (MRR) Churn Rate – Calculation**
= Churned (or lost) MRR / Previous Month's MRR x 100

- **Customer Churn Rate**

Similar to the previous calculation, this one tracks the percentage of lost customers.

- **Customer Churn Rate – Calculation**
= Number of Customers Lost in the Period / Number of Customers at the Start of the Period x 100

Please note that a healthy churn rate is around 5-7% annually, which translates to between 0.45% and 0.55% monthly.

- **Revenue Renewal Rate**

For many organizations retention and renewal of subscriptions can be critical to growth. Therefore, looking at what percentage of recurring revenues get renewed is a valuable metric to monitor. The reason this is something that marketers will want to track is because many communications, e.g., email newsletters, promotions, etc., happen with existing customers and those communications should be promoting the value and benefits the organization is

providing. If renewal rates go down, there may be room for improvement in the marketing messages to those existing customers.

- **Revenue Renewal Rate – Calculation**
= (MRR Up for the Renewal at Start of Period – MRR Not Renewed at the End of Period)/MRR Up for Renewal at Start of Period x 100

Return on Investment (ROI) KPIs

In addition to general marketing KPIs, there are a couple of specific return-on-investment calculations that every marketer should understand:

- **Return on Ad Spend (ROAS)**

Return on Ad Spend shows the marketing team how well their ad-specific spending is performing. This does not take into consideration any other marketing or organizational costs. So, this KPI highlights the impact of specific ad spending on the marketing budget and, from a paid advertising perspective, can provide important benchmarks as to what is working and what is not.

- **Return on Ad Spend (ROAS) – Calculation**
= Revenue Generated by Ad / Cost of Ad

- **Return on Investment (ROI)**

While similar, return on investment incorporates *all* expenses related to revenues and highlights the impact to the overall organizational costs.

- **Return on Investment (ROI) – Calculation**
= Total Revenues – Total Expenses Related to those Revenues (Net Profit) / Total Expenses Related to those Revenues

Example

Your company spends \$100 on LinkedIn ads in a single month which generates \$600 in revenue. But the following costs are also associated with these revenues:

- Cost to create LinkedIn ad: \$25
- Salary and Overhead (pro-rated) for the marketing person: \$225
- Cost of Goods Sold: \$50

ROAS = Revenue Generated by Ad / Cost of Ad = $600/100 = 6 = 6x$, 6:1, 600%, or \$6 in revenue for every \$1 in spent on LinkedIn Ads

ROI = Total Revenues – Total Expenses Related to those Revenues (Net Profit) / Total Expenses Related to those Revenues = $600 - (100 + 25 + 225 + 50) / (100 + 25 + 225 + 50) = 600 - 400 / 400 = 200 / 400 = 1/2x$, 0.5:1, 50%, or \$0.50 for every \$1 spent on expenses, which now represents a 50% loss to the organization.

The difference between ad centric ROAS and ROI is that ROI is a macro metric that measures how a specific ad affects the *organization's* overall profits, while ROAS is a micro metric that evaluates the effectiveness of the ad itself regardless of the impact it has on an organization's profits. As you can see,

it is important to calculate both these returns since something that looks profitable at the micro (e.g., project or campaign) level may not be profitable at the macro (organizational) level.

Channel-Specific KPIs

In addition to the above categories, there are also many channel-specific KPIs. Most of these have been discussed in previous chapters, but make sure you are combining these with the appropriate general marketing KPIs and organizational KPIs, as well:

- **Search Engine Optimization / Website**

Many of the following were discussed in the **SEO chapter**:

- Leads
- Organic traffic (visitors)
- Keyword ranking
- Search visibility (also called organic market share, SEO visibility, organic visibility, etc.)
- Referral links / backlinks
- Domain authority / domain ranking
- Organic CTR (from search engine results pages)
- Bounce rates
- Average session duration
- Page load speed
- Device type

- **Paid Advertising**

Many of the following were discussed above or in the **Paid Advertising chapter**:

- Impressions and reach
- Clicks
- Click-through rates
- Conversions and conversion rate
- Customer Acquisition Cost (CAC) / Cost per Action (CPA)
- ROAS

- **Social Media**

Many of the following KPIs can be tracked using built-in social media analytics tools, e.g., Facebook Insights, Twitter Analytics, etc.:

- Impressions and reach
- Active followers / connections, i.e., those who are engaging with your content
- Audience growth rates
- Reactions (likes, comments, mentions, shares)
- Click-through rates
- Conversions and conversion rates

- **Mobile**

For mobile websites, the metrics will primarily be similar to the website metrics, just filtered for mobile devices. That said, many of the following KPIs apply to mobile apps:

- Downloads
- Installs
- Uninstalls
- Load time
- Crash rate
- Screen resolutions
- Operating systems
- Daily active users (DAU)
- Session length and frequency
- Retention and churn rates
- Reviews and ratings

For an even more comprehensive list, please review this Guide to Mobile KPIs (<https://uxcam.com/blog/top-50-mobile-app-kpis/>).

- **Email**

Again, these were covered in the **Email Marketing chapter**:

- Delivered (or bounced) emails
- Opened emails
- Click-through rates
- Click-to-open rates
- Unsubscribe rates
- Spam rates
- Conversion rates
- Conversion-to-open rates

Tracking Digital Marketing Campaigns

Now that you know what KPIs to track, let's briefly discuss preparing your digital marketing campaigns so that you can better track your results. One area many marketers neglect is creating customized URLs that can identify *exactly* where a click came from. Fortunately, there is way to easily create customized ad campaign parameters so that you can track campaigns using analytics tools like Google Analytics.

UTM Parameters

Urchin Tracking Module (**UTM**) **parameters** can be added to any URL without affecting where the person clicking on the link ends up. There are five URL parameters that marketers can customize to track the effectiveness of their digital marketing campaigns across a variety of media sources. These five parameters include:

- **UTM Medium**

This field is used to identify the top-level marketing channel being used in the campaign, e.g., social, organic, paid, email, mobile, referral / affiliate, etc.

Example: utm_medium=social

- **UTM Source**

This identifies the specific site within the above channel. For example, "Facebook" could be a source within your "social" medium for any unpaid / organic links posted on Facebook. However, if you were running a paid Facebook ad or boosting a post, "Facebook" would be a source within your "paid" medium. And, if you were building a link for an email campaign, the source might be the specific email list you used.

Example: utm_source=facebook

- **UTM Campaign**

This refers to a specific campaign name. Here marketers can enter any name or description they want, e.g., names that easily identify product launches, promotional campaigns, individual emails, social media posts, etc.

Example: utm_campaign=halloween_2021_promotion

- **UTM Content**

This is an optional field. If you have multiple links in the same campaign, like two links in

the same email, you can fill this in to differentiate between the two links. For many marketers, this field may be more detailed than needed, but it is available as an additional level of tracking detail.

Example: utm_content=email_link_1

- **UTM Term**

This field is also optional and can track specific keywords used for paid campaigns. Since Google Ads has its own tracking methodology and is deeply integrated with Google Analytics, marketers tend to only use this field when creating paid campaigns on other systems, e.g., Facebook, LinkedIn, etc.

Example: utm_term=digital+marketing

For optimal tracking purposes, all marketers should add UTM parameters to their URLs whenever embedding links on external sites or in emails. Then, when someone clicks on that link and lands on the destination page, marketers know exactly which campaign, post, or email the visitors came from, and that data automatically appears in their marketing and analytics tools.

How do UTM parameters work?

In this hypothetical example, we will be sending an email about a specific product to a group of active users. The campaign will not be sent to all email subscribers, but rather those the organization has defined / segmented out as “active.”

Within the email, there is a call-to-action link that sends people to the pricing page. Here’s the standard URL without any tracking:

- www.companysite.com/pricing

If subscribers clicked on the above link, there would not be any information related to where they came from once they landed on the pricing page. However, here’s the same URL with four UTM parameters added:

- www.companysite.com/pricing?utm_source=active%20users&utm_medium=email&utm_campaign=feature%20launch&utm_content=bottom%20cta%20button

Please note that by adding these additional UTM parameters, people will still end up on the same pricing page. These variables simply make it easier for marketers to track the specific **source** of traffic to the pricing page.

Let’s break down each individual element of this customized URL to really understand it: *(colour-coded for illustrative purposes)*

www.yoursite.com/

[pricing?utm_source=active%20users&utm_medium=email&utm_campaign=feature%20launch&utm_content=bottom%20cta%20button](http://www.yoursite.com/pricing?utm_source=active%20users&utm_medium=email&utm_campaign=feature%20launch&utm_content=bottom%20cta%20button)

- yoursite.com/pricing – Same page as the standard URL
- [?](#) – this tells your browser that everything after this point is just data
- [utm_source=active%20users](#) – we have defined “active users” as our UTM Source. Since spaces cannot be used in a URL, the space is replaced with “%20”. As a recommendation, use dashes (-) or underscores (_) instead for better readability.
- [&](#) – this instructs our marketing analytics tools that the previous UTM parameter is complete and a new one is beginning
- [utm_medium=email](#) – the UTM Medium is defined as “email”
- [utm_campaign=feature%20launch](#) – the UTM Campaign is defined as “feature launch”
- [utm_content=bottom%20cta%20button](#) – the UTM Content has “bottom cta button” so we can track specific links within the campaign

While you do not need to use all of the UTM fields, do get in the habit of using Medium, Source, and Campaign consistently. Many analytics tools assume these three will be used together. And by skipping one, you can create data gaps in your reporting. To easily create these customized URLs, Google has a free **UTM Campaign Builder**² that will automatically build these URLs based on the descriptions and information you type in.

To see more about UTM parameters, please feel free to watch the following video, Tracking Campaigns with URL Builder (<https://www.youtube.com/watch?v=pNRgUq5sDhc>):



One or more interactive elements has been excluded from this version of the text. You can view them online here: <https://opentextbc.ca/foundationsdigitalmarketing/?p=140#oembed-1> (#oembed-1)

Analytics Tools

Now that we have created customized URLs, let's briefly discuss the analytics tools that marketers use to analyze and review the results and KPIs from their marketing efforts. Most analytics tools track clicks, webpage visits, paid advertising clicks, email clicks, SEO performance, mobile app activities, and much more. However, the main reason marketers use analytics tools is to track and understand:

- Who are our visitors and customers?
- Where did they come from?
- How do they behave?
- What did they do?
- What is their customer journey?
- How relevant is our online content?
- Which devices are they using?
- Did they convert? And what prompted their conversion?

The data captured by these analytics tools feeds back into **customer personas** and **customer journeys**, allowing marketers to further hone and tweak their activities to better meet the needs and preferences of their target audiences. Analytics tools are critical in understanding how people behave online, how to connect with them, and how to deliver what they want. It is specifically these key insights that make digital marketing so powerful in meeting, and hopefully exceeding, the needs and demands of today's customers.

Here is a list of several common analytics tools that marketers use:

- **Google Analytics**³
Google Analytics (GA) is, by far, the most popular analytics tool. It is used by most

2. Campaign URL Builder (<https://ga-dev-tools.web.app/campaign-url-builder/>)

3. Google Analytics (<https://analytics.google.com/analytics/web/provision/#/provision>)

marketers primarily because it has a powerful, free version that usually covers more than most marketers need. However, since it covers so many areas, it can be overwhelming to learn. For beginners, Google offers a free course, *Google Analytics for Beginners*⁴, that provides a nice overview of what Google Analytics can do and how to begin using it.

- **Statcounter**⁵
Statcounter is a simplified version of Google Analytics and can work well for individuals and small organizations. It offers a simple interface for basic site analytics and reports on web page views, sessions, site visitors, and new visitors. This basic dashboard is free for up to 500 page views. Statcounter also provides advanced paid features, which include reports for bounce rate, conversion rate, and paid traffic.
- **Clicky**⁶
Clicky is another simple, real-time analytics solution. While the tool offers all the basic analytics, such as site referrers and visitors, it also includes some surprising additional features, including heat mapping and uptime monitoring. They offer both free and paid plans.
- **Matomo**⁷
Matomo (*formerly known as Piwik*) is a downloadable, privacy-focused free analytics platform that provides detailed data on your website visitors, including the languages they speak, pages they visit, files they download, keywords they used to find your website, and the referral search engine. This open-source software can be downloaded and installed on your own web servers for free. And the installation process is fairly intuitive for users with no developer skills. For those without access to their own servers, Matomo does provide a paid Cloud solution.
- **Adobe Analytics**⁸
Adobe Analytics is part of the Adobe Experience Cloud suite designed for large, enterprise organizations. It is a robust marketing tool that tracks website and mobile app traffic and real-time user behavior. It uses this data to create product recommendations and customized landing pages. The platform also enables data across all Adobe Cloud products. Since Adobe Analytics is primarily an enterprise solution, it is expensive and may require specialists to use and harness its full potential.
- **Hubspot**⁹
From a marketing perspective, Hubspot needs to be included on this list. While some areas overlap between Hubspot and Google Analytics, many of Hubspot's capabilities are best described as complementary to Google Analytics. Hubspot shines as an all-in-one customer lifecycle analytics tool. Hubspot has a lot of functionality, from landing page creation to social media mention tracking, email performance measurement, and lead nurturing. So, when it comes to managing your digital marketing activities across multiple channels, Hubspot can be a powerful analytics and automation tool.

This is a short list of the most popular analytics tools, primarily from a digital marketer's perspective.

4. Google Analytics for Beginners (<https://analytics.google.com/analytics/academy/course/6>)

5. Statcounter (<https://statcounter.com/>)

6. Clicky (<https://clicky.com/>)

7. Matomo (<https://matomo.org/>)

8. Analytics anywhere in the customer journey (<https://business.adobe.com/ca/products/analytics/adobe-analytics.html>)

9. Marketing Analytics & Dashboard Software (<https://www.hubspot.com/products/marketing/analytics>)

There are many more and for a more comprehensive list, please check out this article, [Google Analytics Alternatives \(https://www.leadfeeder.com/blog/google-analytics-alternatives/\)](https://www.leadfeeder.com/blog/google-analytics-alternatives/). Measuring results is critical to the success of any digital marketing activity. Through measurement and iteration, marketers can improve and optimize their digital marketing efforts and build stronger relationships with their target audiences.

Key Takeaways

Digital marketing analytics are critical to understanding your marketing performance and the needs / interests of your target audiences:

- Track KPIs that you can act on or affect
- Monitor a combination of KPIs:
 - **General marketing and revenue KPIs**
 - CAC
 - LTV / CLTV
 - LTV to CAC Ratio
 - Conversion Rate
 - RPV
 - Monthly Recurring Revenue (MRR) Churn Rate
 - Customer Churn Rate
 - Revenue Renewal Rate
 - **Return on Investment KPIs**
 - ROAS
 - ROI
 - **Channel-specific KPIs**
 - SEO
 - Paid Advertising
 - Social Media
 - Mobile
 - Email
- Setup custom campaign URLs using UTM parameters so that you can track the results in your analytics program
- Analytics tools are critical to understanding how people behave, how to connect with them, and how to deliver what they want. They also support and facilitate campaign optimization and stronger relationships with target audiences.

Digital Marketing Analytics – Additional Resources

Here are several articles and videos that provide more details about digital marketing analytics:

- Digital Marketing KPIs and Metrics (<https://dashthis.com/blog/digital-marketing-kpis-and-metrics-ultimate-guide/>) (+ Template)
- 25 Advertising Metrics (<https://instapage.com/blog/key-advertising-metrics>)
- Marketing Math (<https://www.digitalthirdcoast.com/blog/marketing-math>)
- Digital Marketing Math (<https://www.campaignmonitor.com/blog/email-marketing/2019/03/digital-marketing-math-all-the-formulas-you-need-to-know-on-one-page/>)
- UTM Tracking: What Are UTM Codes and How Do I Use Them? (<https://agencyanalytics.com/blog/utm-tracking>)
- 25 Key Differences: Google Analytics 4 vs Universal Analytics (<https://online-metrics.com/google-analytics-app-web/>)
- Google Analytics 4 vs Universal Analytics: 12 Fundamental questions answered (<https://clicktrust.be/en/level/channel-specialist/google-analytics-4-vs-universal-analytics-12-fundamental-questions-answered/>)
 - Deep Dive on User Analysis Techniques (<https://www.youtube.com/watch?v=LrjggPcRWgY>)(Video)
 - Deep Dive on User Behaviour Techniques (<https://www.youtube.com/watch?v=SaaDLcC0ahM>) (Video)
 - About GA4 Analysis (https://support.google.com/analytics/answer/7579450?hl=en&ref_topic=9266525) – (Google Support Article)

Media Attributions

- Customer Analytics Icon by Rochelle Grayson is licensed under a CC BY 4.0 licence.
- Tracking campaigns with URL Builder (4:37) (<https://www.youtube.com/watch?v=pNRgUq5sDhc>) by Google Analytics (<https://www.youtube.com/@GoogleAnalytics>) is licensed under a Standard YouTube License.

IV

The Future of Digital Marketing

20.

Future Digital Marketing Trends

Learning Objectives

By the end of this chapter, you should be able to:

- **List** five key digital marketing trends
- **Describe** ways new technologies and tools might impact digital marketing in the future

Digital Marketing Trends & Developments

The global pandemic accelerated the growth of digital marketing. With the sudden collapse of face-to-face interactions, both organizations and consumers quickly shifted their attention and activities online. Marketers heavily invested in social media, email marketing, mobile apps, websites, landing pages, blogs, webinars, and a variety of other digital channels to build closer and stronger relationships with more digitally savvy customers. As a result, the world of digital marketing looks quite different post-pandemic, and many digital marketing strategies and tactics are here to stay.

Given this acceleration in digital activity, what does the future hold for digital marketing? While always challenging to predict the future, there are a few trends and emerging behaviours that may signal what is yet to come. Here are five areas that will likely have a significant impact on marketers in the near future:

Marketing Automation / Personalization

Due to the computational power that is now available, artificial intelligence (AI), machine learning (ML), and deep learning (DL) are playing a pivotal role in how marketers perform their jobs. To clarify the differences, artificial intelligence enables computers to mimic human intelligence. Machine learning uses algorithms to parse data, learn from that data, and make informed decisions based on what it has learned. And deep learning structures algorithms in layers to create an “artificial neural network” that can learn and make intelligent decisions on its own.

From a marketer’s perspective, many tools and systems are now using ML to identify meaningful patterns and derive insights based on user data and/or behaviours. As a result, many marketing tasks and activities that used to be done manually are being automated. This potentially frees up marketers to spend more time thinking strategically and creatively about

ways to engage and convert target audiences.

While some early marketing automation is already happening, there is still a great deal of growth that will happen in the coming years. Below are a few examples where machine learning is already helping marketers optimize their marketing activities. That said, many of these technologies are still in their infancy and are only being used by early adopters:

Programmatic Advertising

Programmatic advertising is the use of automated technology to buy advertising space. Instead of a marketer manually bidding, placing content / copy, and choosing the timing for a specific ad, programmatic advertising uses data insights and algorithms to serve ads to the right user at the right time, and at the right price. With these systems, marketers simply provide content, campaign goals, e.g., most impressions (brand awareness), conversions, etc., budget limits, and other campaign constraints, e.g., location, demographic, etc. and the system will optimize the campaigns to deliver the highest possible returns based on the stated goals / constraints. Since computers can monitor, analyze, and adapt to market changes quicker than most humans, programmatic advertising can deliver higher returns, greater efficiency, wider reach, and more ad placements. However, these systems tend to be more expensive, may not always properly match the ad to the audience, and there have been some online click fraud issues associated with programmatic advertising. As with any automated system, it still is important to review the results and to make sure these automated systems are best supporting your specific organizational needs and goals.

Personalization / Recommendation Engines

A **personalization engine** (PE) (also called a recommendation engine) uses insights from a user's behaviour combined with data from other similar users to deliver a personalized experience. The content that is delivered to the user should be contextually relevant and match the user's needs and preferences. Since personalization engines use advanced AI and machine learning-based algorithms to make predictions of what users will need, the more data these engines access and analyze, the more accurate their predictions are. PEs are frequently used for ecommerce to make product recommendations, but they are also widely used by media organizations, e.g., news, music, or streaming companies. Some of the benefits of PEs include:

- Finer customer segmentation, i.e., the ability to segment your audiences into smaller segments and still support their needs
- Tailored marketing messages that can be optimized at the individual level
- Shorter conversion times because the customer journey is much more targeted
- Increased revenues due to promoting complementary and/or related products / services that best meet the user's needs.

While there are many advantages, PEs can be quite expensive and require time to setup and collect enough data before benefitting the target audience. Be aware of the significant upfront investment of both time and money before reaping the benefits of these tools.

Conversational Marketing

Conversational Marketing is a way of engaging with your target audience via real-time, dialogue-driven activities such as live chat, messaging apps, or conversational AI (chatbots). The goal of conversational marketing is to create meaningful customer relationships through conversations and to make the customer experience as smooth and easy as possible. To scale conversational marketing, many marketers are turning to chatbots.

Chatbots can help automate some marketing communications and ensure instant and timely responses to customers. By making conversational AI chatbots an integral part of marketing initiatives, organizations can guide customers through the customer journey more quickly and potentially drive more conversions. Some of the key benefits of a chatbot marketing strategy are time and cost savings, increased customer engagement, faster response times, and increased customer data because the interactions are captured and can be analyzed and reviewed. On the other hand, chatbots do take time to setup and cannot completely replace humans. They work well for repetitive questions, information sharing, etc. However, they do not work well in dealing with emotions or nuance. So, a chatbot may only be a suitable solution for a portion of your customer interactions. For more details on chatbot, check out this article about AI Chatbot Platforms (<https://shanebarker.com/blog/best-ai-chatbot/>).

Predictive Analytics

Predictive analytics use historical data to predict future trends, events, and potential scenarios. Many analytics systems are now moving away from simply reporting what happened to offering forecasts that can help users plan and prepare for the future. The most obvious example is Google Analytics 4. This version of Google Analytics launched in October 2020 and is using machine learning to give users more insights and predictive analytics, often related to improving conversions. Using machine learning to assist marketers in identifying key triggers for improved conversion is an area more digital marketing technologies will likely be focusing on.

Voice Search & Commerce

65% of 25-to-49-year-olds speak to their voice-enabled devices at least once per day, according to a recent study by PwC (<https://www.pwc.com/us/en/services/consulting/library/consumer-intelligence-series/voice-assistants.html>). Whether speaking into their mobile devices or asking a voice-enabled device like Google Nest or Amazon Alexa, more and more people are searching for information using their voice. As a result, voice / oral searches will play a more significant role in the customer discovery process. Marketers need to think beyond traditional keywords and key phrases and consider sentences and questions that might be verbally asked by prospective customers looking for information, products, or services. Voice search has become a hot topic in mobile SEO optimization since users are embracing voice search when typing is either not safe, e.g., when driving, or simply not convenient.

Furthermore, voice search is no longer just about delivering information, but rather also includes voice commerce. Yes, people are buying products and services simply using their voice. Since the ultimate marketing goal is to deliver the right information, at the right time, to the right customer with minimal effort, voice search and commerce will be essential in meeting audiences where they are and in a form that meets their immediate needs.

To prepare for these emerging search queries, marketers need to start thinking about ways people might ask for information related to their product or services. This will often translate into longer search queries, i.e., more words. Make sure your content includes these phrases, questions, etc. Since this area is still developing, now is the time to experiment and to learn so that when voice search and commerce take off, you are well positioned to take advantage of the market growth.

Social Commerce

Fueled by the global pandemic and the shift to online shopping, more people are also merging their social media activity with their shopping activity. Instagram and TikTok have brought new meaning to social commerce by launching several features that allow users to buy products directly from within the social media platforms. Since many people already follow brands, these networks are making it even easier to convert.

Brands are leveraging social media checkout and shopping integrations as tech-savvy consumers engage with social commerce more. To successfully compete in the social commerce market, marketers will need to explore influencer marketing, creative calls-to-action, and user-generated content. With over \$350 Billion in social commerce sales, China leads this market. So, marketers entering this emerging commerce market may want to look to China for a road map and inspiration.

Extended Reality (XR) & Immersive Experiences

Even though marketers have been discussing virtual reality (VR) for decades, there are some interesting developments happening around extended reality (XR) and immersive experiences that should be noted. **Extended reality (XR)** is an umbrella term referring to all real-and-virtual combined environments and interactions generated by computer technology. It includes augmented reality (AR) and virtual reality (VR). **Augmented reality** is an interactive 3D experience that combines a view of the real world with computer-generated elements, usually overlaid on top of the real-world view. Since audiences want dynamic, engaging experiences, marketers need to move beyond static text-based messages and provide more immersive experiences.

In contrast to virtual reality (VR) experiences, AR experiences can offer an immersive experience with little additional hardware required – often just a mobile device. This makes these experiences much more accessible to a wider audience. However, these immersive experiences all require significant upfront investments in time and money. That said, the cost of many rich media production technologies started off quite high. So, perhaps in the coming years we will see the production costs and capabilities drop to allow more marketers to develop these compelling and engaging experiences. Here is an example of a 360 VR marketing video (<https://www.youtube.com/watch?v=FzrpkXlRP1M>):



One or more interactive elements has been excluded from this version of the text. You can view them online here:
<https://opentextbc.ca/foundationsdigitalmarketing/?p=144#oembed-1> (#oembed-1)

Consumer Privacy & Data Ethics

As more and more data is collected and tracked, there will continue to be a tension between marketers wanting to know more about their target audiences and consumers wanting to protect their privacy and personal data. There already are concerns about the end of 3rd-party cookies in 2023 and the potential impact on advertisers.¹ And as discussed in the **Email** chapter, data protection is being monitored by governments across the globe. As a result, marketers will have to rely on building truly meaningful relationships with their target audiences that are based on trust, value, and consent, which brings us to data ethics.

Data ethics is about responsible and sustainable use of data. Marketers will need to have policies in place that serve their audiences well. This will likely involve giving consumers more control over their data, providing a level of transparency, holding organizations accountable, and keeping customer data secure. As we all know, data is a powerful asset for any organization. Yet, with this power comes increased organizational responsibility to use it wisely, appropriately, and ethically.

Digital marketing has grown exponentially in recent years. With the emerging trends and developments mentioned above, the future looks very bright. There will likely be even more technological advances and discoveries that will spark, challenge, and drive new creative and compelling marketing experiences. As long as marketers continue to meet the needs, wants, and desires of their target audiences, it will undoubtedly be an exciting journey for us all.

Key Takeaways

While there are always new digital marketing channels emerging, the following trends and developments will likely have the most significant impact on marketers in the coming years:

- Marketing Automation / Personalization
- Voice Search & Commerce
- Social Commerce
- Extended Reality & Immersive Experiences
- Consumer Privacy & Data Ethics

Media Attributions

- Experience Amsterdam: A Guided City Tour – 360 VR Video (<https://www.youtube.com/watch?v=FzrkpXlRP1M>) by VR Gorilla – Virtual Reality & 360 Videos (<https://www.youtube.com/@Vrgorilla1>) is licensed under a Standard YouTube License.

1. How To Prepare Your Digital Marketing for the End of Third-Party Cookies (<https://boldorange.com/news/how-to-prepare-your-digital-marketing-for-the-end-of-third-party-cookies/>)

About the Author



Rochelle Grayson (MBA in Finance and Business Policy, University of Chicago) is the department chair and Professor of Marketing at Langara College's School of Management. She is also the industry chair, program advisor, and an instructor for the University of British Columbia's Sauder School of Business Digital Leadership and Data & Marketing Analytics Programs. In addition to her educational roles, Rochelle is also an Executive-in-Residence with New Ventures BC, where she mentors growth-stage technology companies around their sales and marketing strategies. Rochelle holds a BA in German Literature from Swarthmore College, as well as Six Sigma (Blackbelt) master certifications in Product Development Management and Business Facilitation.

Because Rochelle straddles the worlds of industry and academia, she teaches using a global, applied and innovative approach. Rochelle has taught Canadian and international students ranging from high-school through to Executive Education and has received the UBC John K.

Friesen Excellence in Teaching award. Rochelle has introduced simulations and courses in Digital Marketing and Social Media to both Langara College and the the University of British Columbia. Rochelle enjoys leveraging recent technological and business developments in her classes and is focused on preparing her students for the jobs of the future. Furthermore, as a trilingual, multicultural individual who has lived and worked in Africa, Europe, Latin America, and North America, Rochelle truly appreciates and brings a global perspective to her classrooms.

Rochelle has led and launched numerous innovative digital initiatives, working with a combination of both large and small companies. Rochelle is the co-founder of ArtSites, a digital marketing firm for visual artists, and is past president of Work at Play, a digital agency focused on community building and digital content monetization for large US entertainment companies such as MTV, Mattel, and Warner Brothers. Rochelle is also a past president of OBehave! Entertainment, an early mobile social networking company, co-founder of Elastic Entertainment, a digital media entertainment company, chief business agilist with Agile Business Strategies, CEO and co-founder of FlashLog, an early blogging and newsletter management system, chief blogger of FlashCommerce.com, founder of The Media Mavens podcast, and founder of VidCamp: a media 2.0 unconference.

Rochelle has been on the boards for the Canadian Women and Sport, the Canadian Internet Registration Authority, Canadian Women in Communications, Women in Film and Television (Vancouver and Germany), Computers for Schools, and New Media BC. She has also been a juror for the Canadian Media Fund and the Chair of Creative BC's Interactive Fund. When she's not teaching, Rochelle enjoys long 3 – 5 km swims, singing Jazz, and traveling the world with her husband of over 25 years, Geoff.

Versioning History

This page provides a record of edits and changes made to this book since its initial publication. Whenever edits or updates are made in the text, we provide a record and description of those changes here. If the change is minor, the version number increases by 0.01. If the edits involve substantial updates, the version number increases to the next full number.

The files posted by this book always reflect the most recent version. If you find an error in this book, please fill out the Report an Error (<https://collection.bccampus.ca/report-error/>) form.

Version	Date	Change	Details
1.00	March 23, 2023	Book published.	